

Installation Manual

 *I-Sniper* DAY/NIGHT INDOOR DOME CAMERA

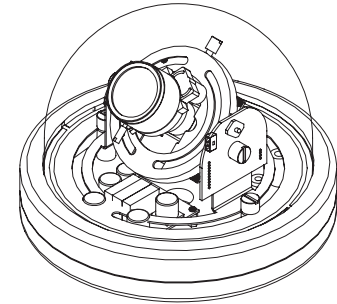

EL-720



EL-720 I-SNIPER DAY/NIGHT INDOOR DOME CAMERA

Copyright 2013, ICRealtime, Inc. Made in Korea.

Please read this manual carefully before installation and operation of the product.

PRECAUTIONS

By selecting this product, you have decided to use a professional device that guarantees highest quality and reliability. We would like to thank you very much for your confidence and kindly ask you to read the following instructions carefully before installation and operation in order to take full advantage of all quality features regarding this product.

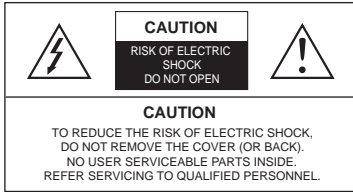

The lightning flash with an arrowhead symbol, within an equilateral triangle is intended to alert the user to the presence of uninsulated dangerous voltage within the product's enclosure that may be of sufficient magnitude to constitute a risk of electric shock to persons.



The exclamation point within an equilateral triangle is intended to alert the user to the presence of important operating and maintenance (servicing) instructions in the literature accompanying the appliance.

INFORMATION

This equipment has been tested and found to comply with limits for a Class A digital device, pursuant to part 15 of the FCC Rules. These limits are designed to provide reasonable protection against harmful interference when the equipment is operated in a commercial environment. This equipment generates, uses, and can radiate radio frequency energy and, if not installed and used in accordance with the instruction manual, may cause harmful interference to radio communications. Operation of this equipment in a residential area is likely to cause harmful interference in which case the user will be required to correct the interference at his own expense.

WARNING

Changes or modifications not expressly approved by the manufacturer could void the user's authority to operate the equipment.

CAUTION – To prevent electric shock and risk of the fire hazards

- Do NOT use power source other than that specified.
- Do NOT expose this appliance to rain or moisture.

This installation should be made by a qualified service person and should conform to all local codes.

Table of contents

1. Precautions -----	4
2. Limitation of liability -----	5
3. Disclaimer of warranty -----	5
4. Package -----	6
5. Main Features -----	6
6. Assembly overview -----	7~11
7. Troubleshooting -----	12
8. Dimension (mm) -----	13
9. Specification -----	14
10. OSD Manual for function control-----	15~18

1. Precautions

- Please read the manual carefully before the installation in order to make use the camera to be set up correctly and to have the best picture quality.
- Please keep the manual in good condition for your future reference and service application.
- Installation and services should only be carried out by an authorized personnel according to local safety regulations.
- If any liquid or solid matter gets into the housing, immediately disconnect the camera from power supply and have it checked by your authorized dealer before reusing.
- Avoid installing the camera at extremely hot or cold places.
- If you are not a certified person, never try to dismantle the camera. To avoid electric shock, never remove the screws or covers. There are no parts inside that need maintenance by the user. All maintenance should be carried by qualified personnel.
- Avoid installing the camera at a place of high humidity.
- Avoid installing the camera at the place exposed to gas or oil.
- Keep the top glass of the lens always clean in order to obtain the best picture quality all the time. Be careful not to be stained by fingerprint.
- Don't face the camera directly toward sunlight or sunlight reflecting area. CCD may go defective at this condition.
- Please give a special attention to keep the unit from dangerous drop or external shock during the process of transportation or handling.
- Never try to touch the camera in wet hand. It may cause an electric shock.
- Do not expose the camera to radioactivity. It causes a serious damage on the CCD.

2. Limitation of liability

This publication is provided "AS IS" without warranty of any kind, either express or implied, including but not limited to, the implied warranties of merchantability, fitness for any particular purpose, or noninfringement of the third party's right. This publication could include technical inaccuracies or typographical errors. Changes are added to the information herein, at any time, for the improvements of this publication and/or the corresponding product(s).

3. Disclaimer of warranty

In no event shall seller be liable to any party or any person, except for replacement or reasonable maintenance of the product, for the cases, including but not limited to below :

- (1) Any damage and loss, including without limitation, direct or indirect, special, consequential or exemplary, arising out of or relating to the product;
- (2) Personal injury or any damage caused by inappropriate use or negligent operation of the user;
- (3) unauthorized disassemble, repair or modification of the product by the user;
- (4) Inconvenience or any loss arising when images are not displayed, due to any reason or cause including any failure or problem of the product;
- (5) Any problem, consequential inconvenience, or loss or damage, arising out of the system combined by the devices of third party.
- (6) Any claim or action for damages, brought by any person or organization being photogenic subject, due to violation of privacy with the result of that surveillance-camera's picture, including saved data, for some reason, becomes public or is used for the purpose other than surveillance.

4. Package

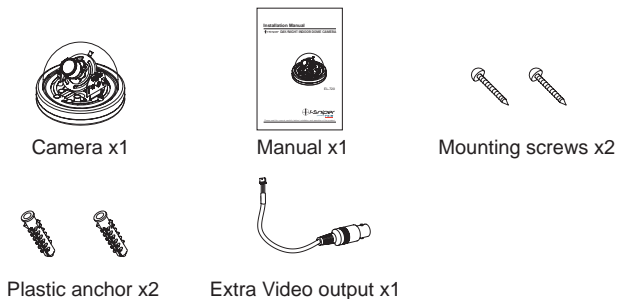

5. Main Features

- 1/3" I-Sniper PIXIM DPS image sensor
- 690TVL / 960H Effective Pixels
- 2.8-12mm Vari-Focal Lens
- WDR (Wide Dynamic Range)
- 2D/3D Digital Noise Reduction
- DIS (Digital Image Stabilizer)
- True Day and Night (ICR)
- Intelligent Functions
- Highlight Eclipse Function
- Digital Zoom
- Motion Detection
- Privacy Masking
- RS-485 Interface (Pelco-D)
- 12VDC/24VA Power Input



I-Sniper, the most accurate chip in the world, is an imaging solution created exclusively by Pixim for IC Realtime. I-Sniper cameras deliver clear, detailed images in real-world scenes, night and day, even under challenging, mixed lighting conditions.

I-Sniper cameras have been custom tuned with camera settings specifically for ICRealtime's line of DVRs, resulting in 25-45% longer recording times vs. nonoptimized 3rd party cameras.

6. Assembly overview

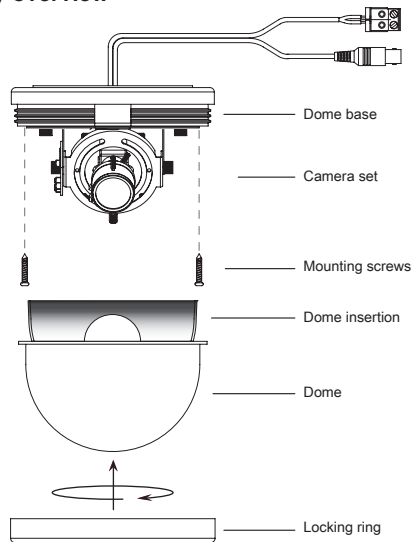

6-1. Installation

- Installation and services should only be carried out by an authorized personnel according to local safety regulations.
- Should liquid or solid matter gets into the housing, disconnect the camera immediately from the power source and have it checked by your authorized dealer before reusing it.
- Keep an adequate distance from direct heat sources.
- Avoid installing the camera at a place of high humidity.
- Avoid installing the camera at a place exposed to gas or oil.
- Keep the top glass of the lens always clear in order to obtain the best picture quality all the time. Be careful not to stain the lens by fingerprints.
- Do not point the camera toward artificial lightings, the sun, the sky or to the direction of a window. The best picture quality will be achieved if both camera and lighting point to the area you want to record.
- Do not expose the camera to radioactivity. It causes a serious damage on the CCD.
- Do not put objects inside the unit. Make sure that no metal objects or flammable substances get into the camera. It could cause fire, short-circuits or damages.
- Install the camera away from electric or magnetic fields.

6-2. Overview of 3 directional adjustment

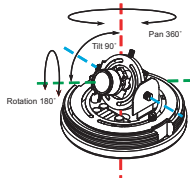

Perfect Tri-axis!

- * Pan angle 360°
- * Tilt 90°
- * Rotation angle 180°

Please lock the levers with enough strength after adjustments so that the lens angle stays its direction firmly against vibration or external shock.

6-3. Name and function of each part

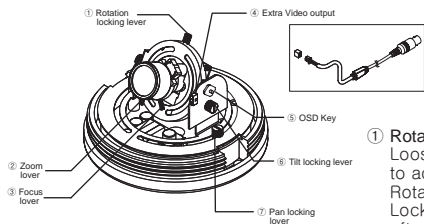

- ① **Rotation locking lever**
Loose it by turning it lefthandwise to adjust the camera angle to Rotation axis.
Lock it by turning it righthandwise after adjustment.

- ② **Zoom lever**
Loose it by turning it lefthandwise to adjust the Zoom in/out. Lock it by turning it righthandwise after adjustment.
- ③ **Focus lever**
Loose it by turning it lefthandwise to adjust the Focus. Lock it by turning it righthandwise after adjustment.
- ④ **Extra video output**
Use this terminal with the supplied Short video cable hooked up. Use it only for checking the picture quality and function adjustments. Remove the short cable after adjustments.
- ⑤ **OSD Key**
Please refer to the page 10~12 in this manual for the use of OSD buttons.
- ⑥ **Tilt locking lever**
Loose it by turning it lefthandwise to adjust the camera angle to Vertical axis.
Lock it by turning it righthandwise after adjustment.
- ⑦ **Pan locking lever**
Loose it by turning it lefthandwise to adjust the camera angle to Horizontal axis.
Lock it by turning it righthandwise after adjustment.

★ **Caution** –Please make sure that the surface of the lens and the dome cover stay always clean. When these parts are contaminated, clean them very carefully with soft cloth. Even a small scratch on these parts results in the picture blooming or reflection.

6-4. Mounting applications

This unit provides an efficient way of mechanical adjustment of the camera angle from any location. Especially, noticeable points are Vertical angle that can be tilt down to 90 degree and the Rotation adjustment that can correct the image to be always upright status when the dome camera is installed on the wall or on the slope.

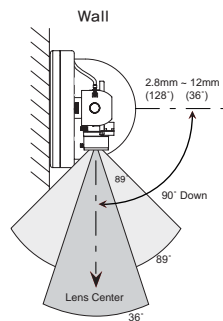
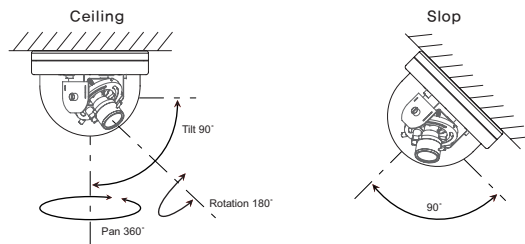

- Vertical angle can be tilt down to its maximum 90 degree. (TILT = 90°)
- Horizontal angle is adjustable to its maximum 360 degree. (Horizontal = 360°)
- Rotation angle is adjustable to its maximum 180 degree. (Rotation = 180°)

6-5. Video Monitor

Connect Video cable with BNC-male connector to the monitor.

- Impedance alliance in the system connection.

Make sure to connect the cable with the power off. Please locate the impedance switch of each equipment as instructed.

- Locate the switch to HI-z position for the interim equipment.
- Locate the switch to 75Ω for the last equipment.

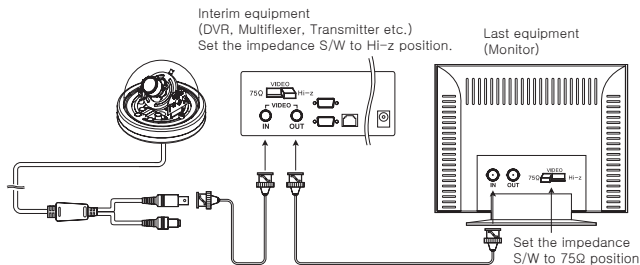

6-6. Power

Please check if the model is 12VDC or 24VAC before the installation.

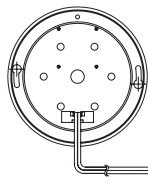

12VDC/24VAC Dual power camera
You can use either 12VDC Power or 24VAC Power source with non-polarity connection.

BNC - Fe
(Video out)
2P Terminal block
(Non-Polarity)

6-7. RS-485 Cable



TRX+(GREEN CABLE)
TRX-(BLUE CABLE)

6-8. Connecting to VIDEO and POWER

A. Connecting to VIDEO

Connect a coaxial cable (procured locally) to the video output connector.

※Note.

Be sure to turn off the power of each device before connecting.

B. Connecting to POWER

The recommended adapter specification is DC12V/500mA, AC24V/300mA. Please check the standard power requirement before connecting the power. Additionally, waterproofing work is needed at the joint (e.g. wrapping waterproof tape)

Power Cable length and AWG (Extension)

As shown in the table below, voltage drops as the wire is longer so that the use of an excessively long power cable (or extension cable use) to the camera may affect the camera's performance, even may be burnt.

Copper wire Size (AWG)	0.22mm ² (#24)	0.33mm ² (#22)	0.52mm ² (#20)	0.83mm ² (#18)	1.3mm ² (#16)
Resistance (Ω/m)	0.1	0.06	0.04	0.03	0.01
Voltage Drop (V/m)	0.113	0.068	0.049	0.03	0.019

The resistance value of Copper Wire: 25° C (77° F)

- Standard Voltage for proper camera operation is DC12V +/- 10%/ AC24V +/-10%
- AWG #24 : 10M is the maximum cable distance for proper operation, Longer than 10 Meters, it may cause damage to the product.
The manufacture is not liable for problems caused by unauthorized installation.
- AWG26, AWG28: It is not recommended. It causes a severe damage to the camera; a burnt / short circuit, injury or fire.

Cautions!

- There may be a deviation in voltage drop depending on the type of wire and its manufacturer.
- Please do connect one camera by the input power! No other devices!
- Please power on after installation finished.

7. Troubleshooting

Problems	Troubleshooting			
Nothing appears on the screen.	<ul style="list-style-type: none"> • Please check that the power cord and line connection between the camera and the monitor are fixed properly. • Please check that you have properly connected VIDEO cable to the camera. • VIDEO output jack. Check DC Iris cable on Lens is properly connected. 			
The image on the screen is dim.	<ul style="list-style-type: none"> • Is lens stained with dirt? Clean your lens with soft, clean cloth. • Set the monitor to proper condition. • If the camera is exposed to too strong light, change the camera position. 			
The image on the screen is dark.	<ul style="list-style-type: none"> • Adjust the contrast feature of the monitor. • If you have an intermediate device, set the 75Ω / Hi-Z properly (Please check the impedance) 			
The camera is not working properly, and the surface of the camera is hot.	<ul style="list-style-type: none"> • Please check that you have properly connected the camera to an appropriate power source. 			
Color is not correct.	<ul style="list-style-type: none"> • Please check the setting of WHITE BAL SETUP menu. 			
The screen flickers continually.	<ul style="list-style-type: none"> • Please check that direction of camera is turned toward the Sun. 			
RS-485 communication fails.	<ul style="list-style-type: none"> • Please check the polarity between RS-485 Control Port and RS-485 cable. 			
	485 Control Board Connection Port	RS-485 Control Port		
	(+)CONNECTION TERMINAL(TRX+)	485+		
	(-)CONNECTION TERMINAL(TRX-)	485-		
	<ul style="list-style-type: none"> • Please check if the initial value of the RS-485 Communication setup matches between camera and OSD Controller or DVR. * RS-485 Communication establishment initial value 			
	Item	Camera ID	BAUD RATE	UART MODE
Initial value	1	9600	8-NONE-1	ENABLE
<ul style="list-style-type: none"> • We recommend that you make ground connection between camera and controller for safe communication control. • When RS-485 cable is not properly connected, A warning message 'ERROR RS-485 Connection. Please reconnect and Reboot' is displayed. Then please turn off the power and connect the cable again. 				

8. Dimensions (mm)

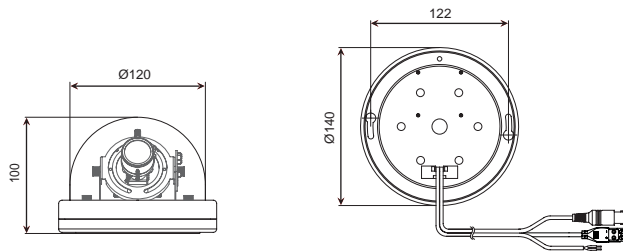

9. Specification

General	EL-720
Image sensor	1/3"Pixim WDR digital image device
Effective pixels	410,000 pixels 758 (H) X 540(V)
H.Resolution	690HTVL effective
Synchronizing system	Internal
Video output	1.0Vp-p Composite 75Ohms
S/N ratio	50dB(AGC OFF, Weight ON)
Min.Illumination	0.1 Lux at F1.2
Shutter speed	1/25 sec ~ 1/30,720sec (Global Shutter)
Gamma control	Standard $\gamma=0.45$
White Balance	2000°K ~ 11,000°K Auto. ATW/ AWB selectable by OSD
Power source	12VDC / 24VAC
Operating current	210mA / 12VDC, 110mA/ 24VAC
Lens	2.8 ~ 12mm Varifocal Lens
Iris control	DC IRIS
MTBF of IR	80,000 hours
Operating temp	-10°C ~ 50°C
Humidity	0%RH ~ 90%RH
Measurement(mm)	120(dia.) x 100(H)
Weight(Approx.g)	1200
Function	
WDR	Low/ Normal /Middle/ High
AGC	Low/ Normal /High
BLC	On/Off
Fluorescent	Off/ CRR/ CRR2
ICR DVR Tool	Off/ EDGE/ MAX/ FLEX/ ELITE
RS485	Pelco-D
Flip	Off/ Horiz/ Vert/ Both

■ Specifications are subject to change without prior notice to enhance performance and stability

10. OSD Manual for functions control

OSD Menu Tree

ICREALTIME					
WDR CONTROL	LOW	NORMAL	MIDDLE	HIGH	
BLC	OFF	ON			
AGC	LOW	NORMAL	HIGH		
WHITE BALANCE	ATW	AWB..			
FLUORESCENT	OFF	CRR	CRR2		
ICR DVR TOOL	OFF	EDGE SERIES	MAX SERIES	FLEX SERIES	ELITE SERIES
RS-485	CAMERA #	PROTOCOL	BAUD RATE	RETURN	
FLIP	OFF	BOTH	VERT	HORIZ	
SAVE&EXIT	DEFAULT	CANCEL			

Setting up the menu

- Press the Tact SW to enter <MAIN MENU>
- Move the arrow to a specific menu by pushing the Tact SW up or down.
- Adjust the selected feature by pushing the Tact SW left or right

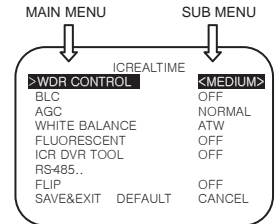
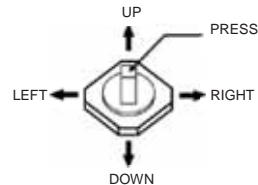

How to use OSD button (Tact SW)

- Press to enter the menu to save settings
- Push up or down to select functions
- Push left or right to adjust a level or mode of sub-menu

- When completed, move the arrow indicator to SAVE&EXIT and press the TACT SW to finish all settings.

1. WDR(Wide Dynamic Range) CONTROL

Light level is controllable with provided easy-to-use OSD menu that enables the camera to be ideally set up for the most of different levels of backlight or contrast lighting situations.

LOW :	Dynamic range level similar to that of CCD cameras.
NORMAL:	Suitable for most indoor scenes without windows or difficult lighting
MIDDLE:	Suitable for normal outdoor scenes and indoor scenes that include windows.
HIGH :	Maximum setting for harsh outdoor scenes

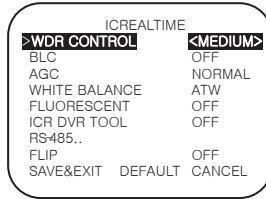

2.BLC(Back Light Compensation)

OFF :	Highlights in image are prioritized.
ON :	Shadows in image are prioritized.

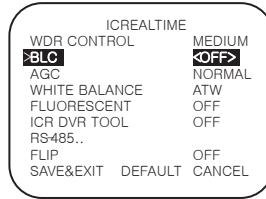

3.AGC (Auto Gain Control)

LOW :	Low gain limit.
NORMAL:	Normal gain limit.
HIGH :	High gain limit.

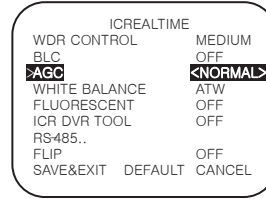

4. White Balance

The Automatic White Balance provides an extensive range color temperature control that covers from 2,000°K to 11,000°K generating natural color image without being red or blue in varying light conditions.

ATW :	Auto-tracking white balance mode.
AWB :	Set white balance now and lock it

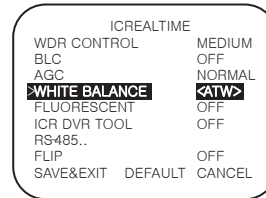

5. Fluorescent

Color Rolling Reduction (CRR)

OFF :	Not used CRR.
CRR :	This color roll reduction mode will work with manual and auto-iris lenses. However, using it with auto-iris lenses typically results in noticeable levels of noise in shadows or dark areas in the image.
CRR2	This color roll reduction mode works with auto-iris lenses ONLY. Noise levels are reduced in shadows or dark areas in the image compared to the noise levels present when using the CRR mode, but, dynamic range is also reduced further.

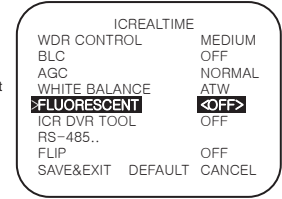

6. ICR DVR TOOL

Ideal setting with IC Realtime DVR series.

OFF :	Default Setting.
EDGE SERIES :	EDGE series
MAX SERIES :	MAX series
FLEX SERIES :	FLEX series
ELITE SERIES :	ELITE series

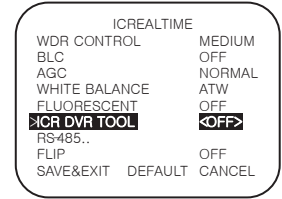

7. RS-485..

CAMERA# :	Available to set up from 1 to 255.
PROTOCOL :	Supports PELCO-D.
BAUD RATE :	Select a baud rate.(2400, 4800, 9600, 19200)
RETURN.	Move to MAIN MENU.

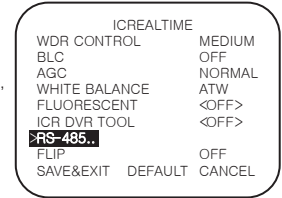

*How to control OSD menu over RS485:
"PRESET" key or "IRIS OPEN" key.

- 1) Set communication speed on the camera to 9600bps.
- 2) Accord the ID of the camera with the DVR or PTZ controller. The factory default ID of the camera is "CAM1".
- 3) On the DVR or PTZ controller, press 95 then press
- 4) When the MAIN MENU pops up on the screen, move the cursor using a joystick to the desired menu to control. When entering a Sub menu, press "IRIS OPEN" momentarily.

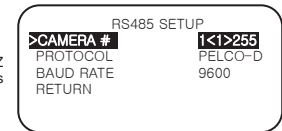

8. FLIP

Adjustable to OFF, HORIZ, VERT, BOTH.

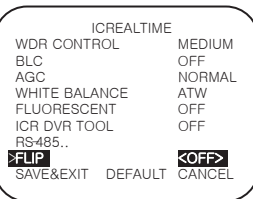
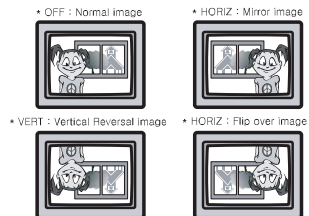

9. SAVE&EXIT

Saves the current settings and exits the menu.

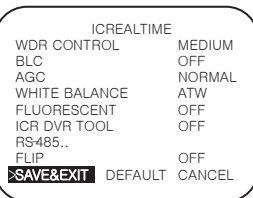

10. DEFAULT

All the settings will be restored to the factory default.

Note.

RS-485 settings are not initialized.

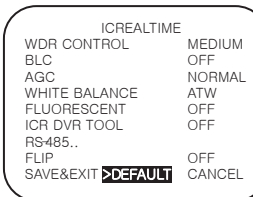

11. CANCEL

Not saves the current settings and exits the menu.

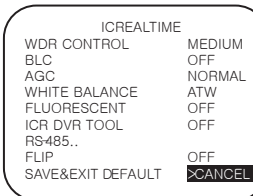

MEMO

MEMO

MEMO

MEMO

MEMO