

Standalone DVR User's Manual

V1.2.0

Table of Contents

1	FEATURES AND SPECIFICATIONS	1
1.1	Overview	1
1.2	Features.....	1
1.3	Specifications.....	2
1.3.1	AVR-4M308/AVR-4M316	2
1.3.2	AVR-808S	4
2	OVERVIEW AND CONTROLS.....	7
2.1	Front Panel.....	7
2.2	Rear Panel.....	7
2.3	Connection Sample.....	9
2.4	Remote Control.....	10
2.5	Mouse Control.....	12
2.6	Virtual Keyboard & Front Panel.....	14
2.6.1	Virtual Keyboard	14
2.6.2	Front Panel	14
3	INSTALLATION AND CONNECTIONS	15
3.1	Check Unpacked DVR.....	15

3.2	About Front Panel and Rear Panel.....	15
3.3	HDD Installation.....	15
3.3.1	HDD Calculation	15
3.3.2	HDD Installation	16
3.3.3	Rack Installation.....	18
3.4	Connecting Power Supply.....	18
3.5	Connecting Video Input and Output Devices	19
3.5.1	Connecting Video Input	19
3.5.2	Connecting Video Output	19
3.6	Connecting Audio Input & Output, Bidirectional Audio	19
3.6.1	Audio Input.....	19
3.6.2	Audio Output.....	20
3.7	Alarm Input and Output Connection	20
3.7.1	Alarm Input and Output Details.....	21
3.7.2	Alarm Input Port	21
3.7.3	Alarm Output Port	22
3.8	RS485	23
3.9	Other Interfaces	23
4	OVERVIEW OF NAVIGATION AND CONTROLS	24
4.1	Initial Settings.....	24
4.1.1	Boot up	24
4.1.2	Set Password	24
4.1.3	Reset Password.....	25
4.2	Startup Wizard and Login.....	26
4.2.1	General.....	27

4.2.2	Network	31
4.2.3	P2P	32
4.2.4	Registration.....	34
4.2.5	Encode	39
4.2.6	Schedule	43
4.3	Preview	48
4.3.1	Preview Window	48
4.3.2	Preview Control.....	48
4.3.3	Right-Click Menu.....	51
4.3.4	Window Switch.....	52
4.3.5	Video Color	52
4.3.6	Image.....	54
4.3.7	Auto Focus.....	56
4.3.8	Preview and Display.....	57
4.3.9	Tour.....	60
4.4	Search Human Face (Optional).....	63
4.5	Fisheye.....	64
4.5.1	Fisheye De-Warp During Preview Interface	64
4.5.2	Fisheye De-Warp During Playback.....	66
4.6	Smart Track.....	66
4.7	PTZ Control.....	66
4.7.1	PTZ Settings.....	67
4.7.2	PTZ Operation.....	68
4.7.3	Coaxial Control.....	70
4.7.4	Set PTZ Functions	71
4.7.5	Call PTZ Functions	74
4.8	Navigation Bar	75
4.8.1	Main Menu	75
4.8.2	Output Screen	75
4.8.3	Previous/Next Screen	75
4.8.4	Tour.....	75
4.8.5	Favorites	76
4.8.6	Channel.....	77
4.8.7	PTZ	78
4.8.8	Color	78
4.8.9	Search	78
4.8.10	Alarm Status	78

4.8.11	Channel Info	78
4.8.12	Registration.....	78
4.8.13	Network	79
4.8.14	HDD Manager.....	79
4.8.15	USB Manager	79
4.9	Record and Snapshot.....	79
4.9.1	Snapshot.....	79
4.9.2	Record.....	84
4.10	Search and Playback.....	87
4.10.1	Instant Playback.....	87
4.10.2	Search	87
4.10.3	Smart Search Playback.....	94
4.10.4	Mark Playback.....	94
4.10.5	Playback Image.....	96
4.10.6	Splice Playback.....	96
4.10.7	File List	97
4.10.8	Lock or Unlock File	99
4.10.9	Other Aux Functions	99
4.11	Backup.....	100
4.11.1	File Backup	100
4.11.2	USB Device Auto Pop-up.....	100
4.12	Network.....	101
4.12.1	TCP/IP	101
4.12.2	Connection.....	102
4.12.3	WIFI.....	103
4.12.4	3G.....	104
4.12.5	PPPoE	105
4.12.6	DDNS.....	106
4.12.7	IP Filter	108
4.12.8	Email.....	110
4.12.9	FTP	111
4.12.10	UPnP.....	114
4.12.11	SNMP.....	115
4.12.12	Multicast	117
4.12.13	Auto register	118
4.12.14	Alarm Centre.....	120
4.12.15	P2P	120

4.13	Account Manager	122
4.13.1	Add User	122
4.13.2	Modify user	126
4.13.3	Change Password.....	126
4.13.4	Add/Modify Group.....	126
4.13.5	Security Question.....	128
4.13.6	ONVIF User	129
4.14	Voice Manager.....	131
4.14.1	File List	131
4.14.2	Schedule	132
4.15	Alarm Events.....	133
4.15.1	Video Detect	133
4.15.2	Smart Plan (Optional).....	143
4.15.3	IVS (Optional).....	144
4.15.4	Face Detection (Optional).....	154
4.15.5	People Counting (Optional).....	155
4.15.6	Audio Detect	156
4.15.7	Smart Track (Optional).....	157
4.15.8	Alarm Settings	161
4.15.9	Abnormality	170
4.15.10	Alarm Output.....	174
4.16	Storage.....	174
4.16.1	HDD Manager.....	174
4.16.2	HDD Group	175
4.16.3	Quota	178
4.16.4	HDD Detect.....	179
4.16.5	RAID.....	182
4.16.6	iSCSI.....	184
4.17	Channel Manager.....	185
4.17.1	Image.....	185
4.17.2	Channel Name.....	188
4.17.3	Channel Type	189
4.18	System Settings.....	194
4.18.1	RS232.....	194
4.18.2	POS.....	195

4.19	System Maintain	199
4.19.1	Auto Maintain.....	199
4.19.2	Import/Export	199
4.19.3	Default	200
4.19.4	System Upgrade	201
4.20	Remote Device Manager.....	202
4.20.1	Connection Status.....	202
4.20.2	Firmware	203
4.20.3	Camera Upgrade.....	204
4.21	Info.....	204
4.21.1	System Info	204
4.21.2	Event Info	211
4.21.3	Network Info.....	213
4.21.4	Log Info.....	215
4.22	Shutdown.....	217
5	WEB OPERATION	219
5.1	Network Connection.....	219
5.2	Set Password and Login	219
5.3	Preview	220
5.3.1	LAN Mode	220
5.3.2	WAN Login.....	226
5.4	Search Human Face	227
5.5	Setup.....	228
5.5.1	Camera.....	228
5.5.2	Network	241
5.5.3	Event.....	265
5.5.4	Storage.....	296

5.5.5	Setting	305
5.6	Playback	325
5.6.1	Search Record	325
5.6.2	Mark Playback.....	328
5.6.3	Splice Playback.....	330
5.6.4	File List.....	331
5.6.5	Playback.....	332
5.6.6	Download	332
5.6.7	Load more.....	333
5.6.8	Lock or Unlock File.....	335
5.7	Alarm	336
5.8	Information.....	337
5.8.1	Version	337
5.8.2	Log	337
5.8.3	Online User.....	339
5.8.4	HDD	339
5.8.5	Network Sniffer.....	341
5.9	Log out.....	341
5.10	Un-install Web Control.....	341
6	SMARTPSS	343
7	FAQ	344
APPENDIX A HDD CAPACITY CALCULATION		352
APPENDIX B COMPATIBLE BACKUP DEVICES.....		354
Appendix B-1	Compatible USB list.....	354

Appendix B-2	Compatible SD Card list.....	355
Appendix B-3	Compatible Portable HDD list.....	355
Appendix B-4	Compatible USB DVD List.....	355
Appendix B-5	Compatible SATA DVD List.....	355
Appendix B-6	Compatible SATA HDD List.....	356
APPENDIX C	COMPATIBLE CD/DVD BURNER LIST.....	360
APPENDIX D	COMPATIBLE DISPLAYER LIST	361
APPENDIX E	COMPATIBLE SWITCHER.....	362
APPENDIX F	COMPATIBLE WIRELESS MOUSE LIST.....	363
APPENDIX G	EARTHING.....	364
APPENDIX H	RAID INTRODUCTION.....	370
Appendix H-1	About RAID.....	370
Appendix H-2	RAID Level.....	370
Appendix H-3	RAID Capacity Calculation.....	372
Appendix H-4	RAID Usage Suggestions.....	372

APPENDIX I RJ45-RS232 CONNECTION CABLE DEFINITION373

Welcome

Thank you for purchasing our DVR!

This user's manual is designed to be a reference tool for the installation and operation of your system.

Here you can find information about this series standalone DVR features and functions, as well as a detailed menu tree.

Before installation and operation please read the following safeguards and warnings carefully!

Important Safeguards and Warnings

1 . Electrical safety

All installation and operation here should conform to your local electrical safety codes.

The product must be grounded to reduce the risk of electric shock.

We assume no liability or responsibility for all the fires or electrical shock caused by improper handling or installation.

2 . Transportation security

Heavy stress, violent vibration or water splash are not allowed during transportation, storage and installation.

3 . Installation

Keep upwards. Handle with care.

Do not apply power to the DVR before completing installation.

Do not place objects on the DVR.

4 . Qualified engineers needed

All the examination and repair work should be done by the qualified service engineers.

We are not liable for any problems caused by unauthorized modifications or attempted repair.

5 . Environment

The DVR should be installed in a cool, dry place away from direct sunlight, inflammable, explosive substances and etc.

6. Accessories

Be sure to use all the accessories recommended by manufacturer.

Before installation, please open the package and check all the components are included.

Contact your local retailer ASAP if something is broken in your package.

7. Lithium battery

Improper battery use may result in fire, explosion, or personal injury!

When replace the battery, please make sure you are using the same model!

RISK OF EXPLOSION IF BATTERY IS REPLACED BY AN INCORRECT TYPE.

DISPOSE OF USED BATTERIES ACCORDING TO THE INSTRUCTIONS.



CAUTION

FOR YOUR OWN SAFETY, PLEASE SET SYSTEM DEFAULT PASSWORD AFTER YOU FIRST LOGIN!

1 FEATURES AND SPECIFICATIONS

1.1 Overview

This standalone series DVR is an excellent digital monitor product designed for security field.

It adopts embedded Linux OS to maintain reliable operation. Popular H.264 compression algorithm and G.711 audio compression technology realize high quality, low bit stream. Unique frame by frame play function is suitable for detailed analysis. It has various functions such as record, playback, monitor at the same time and can guarantee audio video synchronization. This series product has advanced technology and strong network data transmission function.

This series device adopts embedded design to achieve high security and reliability. It can work in the local end, and at the same time, when connecting it to the professional surveillance software (PSS), it can connect to the security network to realize strong network and remote monitor function.

This series product can be widely used in various areas such as banking, telecommunication, electric power, interrogation, transportation, intelligent resident zone, factory, warehouse, resources, and water conservancy.

1.2 Features

This series product has the following features:

- **Real-time surveillance**

Support VGA port and HDMI port. Realize the surveillance through displayer. Support HDMI, VGA, and TV output at the same time.

- **Storage function**

Special data format to guarantee data security and can remove the risk of the vicious data modification. Support digital watermark.

- **Compression format**

Support multiple-channel audio and video. An independent hardware decodes the audio and video signal from each channel to maintain video and audio synchronization.

- **Backup function**

Support backup operation via USB port (such as U disk, portable HDD, burner)
Client-end user can download the file to local HDD to backup via network.

- **Record & playback function**

Support each channel real-time record independently, and at the same time it can support search, forward play, network monitor, record search, download and etc.

Support various playback modes: slow play, fast play, backward play and frame by frame play.

Support time title overlay so that you can view event accurate occurred time

Support customized zoom function during the preview.

- **Network operation**

Support network remote real-time monitor, remote record search and remote PTZ control.

- **Alarm activation function**

Several relay alarm outputs to realize alarm activation and on-site light control.

The alarm input port and output has the protection circuit to guarantee device safety.

- **Communication port**

RS485 port can realize alarm input and PTZ control.

RS232 port can connect to keyboard, COM port of PC or the matrix control.

Standard Ethernet port can realize network access function.

The dual-network port has the multiple-access, fault-tolerance, load-balance setup mode.

- **PTZ control**

Support PTZ decoder via RS485.

- **Intelligent operation**

Mouse operation function

In the menu, support copy and paste setup function

- **UPNP (Universal Plug and Play)**

Establish mapping connection between LAN and WAN via UPNP protocol.

- **Camera Self-adaptive**

Auto recognize and work with the general analog camera and HD camera.

Slight function differences may be found due to different series.

1.3 Specifications

1.3.1 AVR-4M308/AVR-4M316

Name	Parameters	AVR-4M308	AVR-4M316
System	Main Processor	Industrial embedded micro controller	
	OS	Embedded LINUX	
Video Parameters	Video Encode Standard	H.264	
	Encode Resolution	4K/4MP/1080P/720P/960H/D1/HD1/2CIF/CIF	

Name	Parameters	AVR-4M308	AVR-4M316
	Video Frame Rate	PAL:1/16~25f/s; NTSC: 1/16~30f/s	
	Video Frame Rate	32Kbps-12288Kbps, For 720P: default setup is 2Mbps, max supports 4Mbps. For 1080P: default setup is 4Mbps, max supports 8Mbps.	
	Bit Stream Type	Video stream/composite stream	
	Dual-Stream	Support	
Audio Parameters	Encode Standard	G.711A/G.711U/PCM	
	Audio Sampling Rate	8KHz, 16Bit	
	Audio Bit Rate	64Kbps	
Video Port	Analog Video Input	8-ch BNC port (HDAVS/AHD/HDTV/ CVBS)	16-ch BNC port (HDAVS/AHD/HDTV/ CVBS)
	Network Video Input	<ul style="list-style-type: none"> There is no IP channel by default. Just click one button to add 56 IP channels. Support A/D switch function. After you disabled one analog channel, you can add one IP channel. System max supports 64 IP channels. Connection total network width: 256Mbps. 	<ul style="list-style-type: none"> There is no IP channel by default. Just click one button to add 48 IP channels. Support A/D switch function. After you disabled one analog channel, you can add one IP channel. System max supports 64 IP channels. Connection total network width: 256Mbps.
	Video Output	1-ch PAL/NTSC, BNC (1.0VP- P, 75Ω) composite video signal output. 1-ch VGA output. 2-ch HDMI output. HDMI port1 has the same video source as the VGA. HDMI port2 can have different video source from the VGA, support GUI operation. Support TV/VGA/HDMI1/HDMI2 video output at the same time.	
	Loop Output	Support	
	Matrix Output	VIDEO OUT supports multiple-window analog channel output.	
Audio Port	External Audio Input	8-chanel BNC port	16-chanel BNC port
	Coaxial Audio Input	N/A	N/A
	Audio Output	1-channel 200-3000mv 5KΩ, BNC port.	
	Bidirectional Talk Input	One independent audio talk input port and one independent output port (200-3000mv 5KΩ,BNC)	

Name	Parameters	AVR-4M308	AVR-4M316
Record	Record Mode	Schedule record/manual record/MD record/alarm record	
	Playback Mode	Instant playback, normal playback, event playback, mark playback, smart playback	
	Record Playback	Max 1/4/8/16-channel playback Customized channel setup playback Max 16-channel 1080P realtime playback or 12MP non realtime playback	
	Backup Mode	HDD, burner, USB device, network backup	
Alarm	Alarm Input	16-channel alarm input	
	Alarm Output	6-channel output (Include one controllable DC+12V output)	
HDD	HDD Port	8 SATA ports, one eSATA port	
	One HDD Space	8T	
Communication Port	Network	2 RJ45 ports, 1000Mbps Ethernet port	
	Communication	1 RS485 port, 1 RS232 port, 1 RS422 port	
	USB	4 USB ports(Two USB2.0 ports at the front panel and two USB3.0 ports at the rear panel)	
Others	Power	AC90~264V 50+2% Hz	
	Power Consumption	≤40W (With adapter, no HDD)	
	Working Temperature	-10°C – +55°C	
	Working Humidity	10%~90%	
	Dimensions	2U case, 444(W) x460 (D) x89mm(H)	
	Weight	7.0-8.0KG(No HDD)	
	Installation Mode	Desktop/rack installation	

1.3.2 AVR-808S

Name	Parameters	AVR-808S
System	Main Processor	Industrial embedded micro controller
	OS	Embedded LINUX
Video Parameters	Video Encode Standard	H.264H, H.264, H.264B
	Encode Resolution	1080P/720P/960H/D1/HD1/2CIF/CIF
	Video Frame Rate	PAL:1/16~25f/s; NTSC: 1/16~30f/s
	Video Frame Rate	32Kbps-8192Kbps, For 720P: default setup is 2Mbps, max supports 4Mbps. For 1080P: default setup is 4Mbps, max supports 8Mbps.

Name	Parameters	AVR-808S
	Bit Stream Type	Video stream/composite stream
	Dual-Stream	Support
Audio Parameters	Encode Standard	G.711A/G.711U/PCM
	Audio Sampling Rate	8KHz, 16Bit
	Audio Bit Rate	64Kbps
Video Port	Analog Video Input	8-ch BNC port(HDAVS/AHD/CVBS)
	Network Video Input	<ul style="list-style-type: none"> ● There is no IP channel by default. ● Just click one button to add 56 IP channels. ● Support A/D switch function, max supports 64 IP channels. ● Resolution: Max 1200W. ● Decode standard: H.265. Connection total network width: 256Mbps
	Video Output	1-channel VGA output, 2-channel HDMI output, 1-channel VIDEO OUT, VGA and HDMI1 output of the same video source; VGA and HDMI2 output of different video sources; VIDEO OUT supports multiple-window analog channel output. HDMI1 supports 4K output, HDMI2 supports 1080P output.
	Loop Output	N/A
	Matrix Output	VIDEO OUT supports multiple-window analog channel output.
Audio Port	External Audio Input	8-channel BNC port
	Coaxial Audio Input	8-channel
	Audio Output	1-channel BNC port.
	Bidirectional Talk Input	One independent audio talk input port and one independent output port (BNC)
Record	Record Mode	Schedule record/manual record/MD record/alarm record
	Playback Mode	Instant playback, normal playback, event playback, mark playback, smart playback
	Record Playback	Max 1/4/8/16-channel playback Customized channel setup playback Max 16-channel 1080P realtime playback or 1200W non realtime playback
	Backup Mode	HDD, burner, USB device, network backup
Alarm	Alarm Input	16-channel alarm input
	Alarm Output	6-channel output
HDD	HDD Port	8 SATA ports, one eSATA port

Name	Parameters	AVR-808S
	One HDD Space	8T
Communication Port	Network	2 RJ45 ports, 1000Mbps Ethernet port
	Communication	1 RS485 port, 1 RS232 port, 1 RS422 port
	USB	4 USB ports(Two USB2.0 ports at the front panel and two USB3.0 ports at the rear panel)
Others	Power	AC90V~264V
	Power Consumption	≤35W
	Working Temperature	-10℃ – +55℃
	Working Humidity	10%~90%
	Dimensions	2U case, 440mm (W) ×460mm (D) ×89mm (H)
	Weight	≤7.30KG
	Installation Mode	Desk

2 Overview and Controls

This section provides information about front panel and rear panel. When you install this series DVR for the first time, please refer to this part first.

2.1 Front Panel

The front panel is shown as below. See Figure 2-1.



Figure 2-1

2.2 Rear Panel

The rear panel is shown as below. See Figure 2-2.

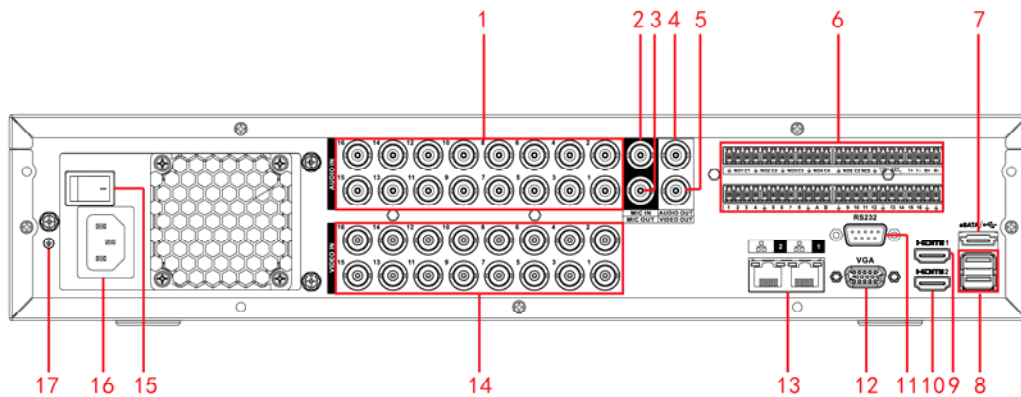







Figure 2-2

Please refer to the following sheet for detailed information.

SN	Icon	Name	Note
1	AUDIO IN	Audio input port	It is to receive the analog audio signal output from the devices such as microphone.
2	MIC IN	Audio input port	Bidirectional talk input port. It is to receive the analog audio signal output from the devices such as microphone, pickup.

SN	Icon	Name	Note
3	MIC OUT	Bidirectional talk output port	<p>Output bidirectional talk analog signal to sound box and etc.</p> <ul style="list-style-type: none"> ● Bidirectional talk output. ● Audio output of single-window monitor mode. ● Audio output of single-window playback mode.
4	AUDIO OUT	Audio output port	Audio output port. It is to output the analog audio signal to the devices such as the sound box.
5	VIDEO OUT	Video output port	Connect to output devices such as TV.
6	1~16	Alarm input port 1~16	<ul style="list-style-type: none"> ● There are four groups. The first group is from port 1 to port 4, the second group is from port 5 to port 8, the third group is from port9 to port 12, the fourth group is from port13 to port 16. They are to receive the signal from the external alarm source. There are two types; NO (normal open)/NC (normal close). ● When your alarm input device is using external power, please make sure the device and the NVR have the same ground.
	NO1~NO5	Alarm output port 1~5	<ul style="list-style-type: none"> ● 5 groups of alarm output ports. (Group 1 : port NO1 ~ C1,Group 2:port NO2~C2,Group 3:port NO3~C3. 4:port NO4~C4. 5:port NO5~C5.).Output alarm signal to the alarm device. Please make sure there is power to the external alarm device. ● NO: Normal open alarm output port. ● NC: Normal close alarm output port. ● C: Alarm output public end.
	C1~C5		
	NC5		
	A	RS485 communication port	RS485_A port. It is the cable A. You can connect to the control devices such as speed dome PTZ.
	B		RS485_B.It is the cable B. You can connect to the control devices such as speed dome PTZ.
T+, T-, R+, R-	Four-cable full-duplex 485 port.	T+, T-: Send out cable. R+, R-: Input cable.	

SN	Icon	Name	Note
	CTRL 12V	Control power output	Control power output of the 6 th alarm output channel. <ul style="list-style-type: none"> ● When there is an alarm output, close the power output. ● When the alarm is cancelled, open the power output.
		GND	Ground
7	eSATA	eSATA port	External SATA port. It can connect to the device of the SATA port.
8		USB port	USB port. Connect to mouse, USB storage device, USB burner and etc.
9	HDMI1	High Definition Media Interface 1	High definition audio and video signal output port. It outputs the same video source as VGA. It supports 4K resolution output and supports mouse operation and control. Please note when the HDMI output resolution is 4K, the VGA output stops.
10	HDMI2	High Definition Media Interface 2	High definition audio and video signal output port. It max supports 1080P resolution. Its video source can be different from the HDMI1/VGA. It supports digital channel output.
11	RS-232	RS-232 debug COM.	It is for general COM debug to configure IP address or transfer transparent COM data.
12	VGA	VGA video output	VGA video output port. Output analog video signal. It can connect to the monitor to view analog video.
13		Network port	1000M Ethernet port
14	VIDEO IN	Video input port	Connect to analog camera to input video signal.
15		Power switch	Power on/off button.
16		Power socket	Power input port
17		GND	Ground
18	Loop out	Loop output port	Output the video signal of the corresponding video input port.

2.3 Connection Sample

Please refer to the following figure for detailed information. See Figure 2-3.

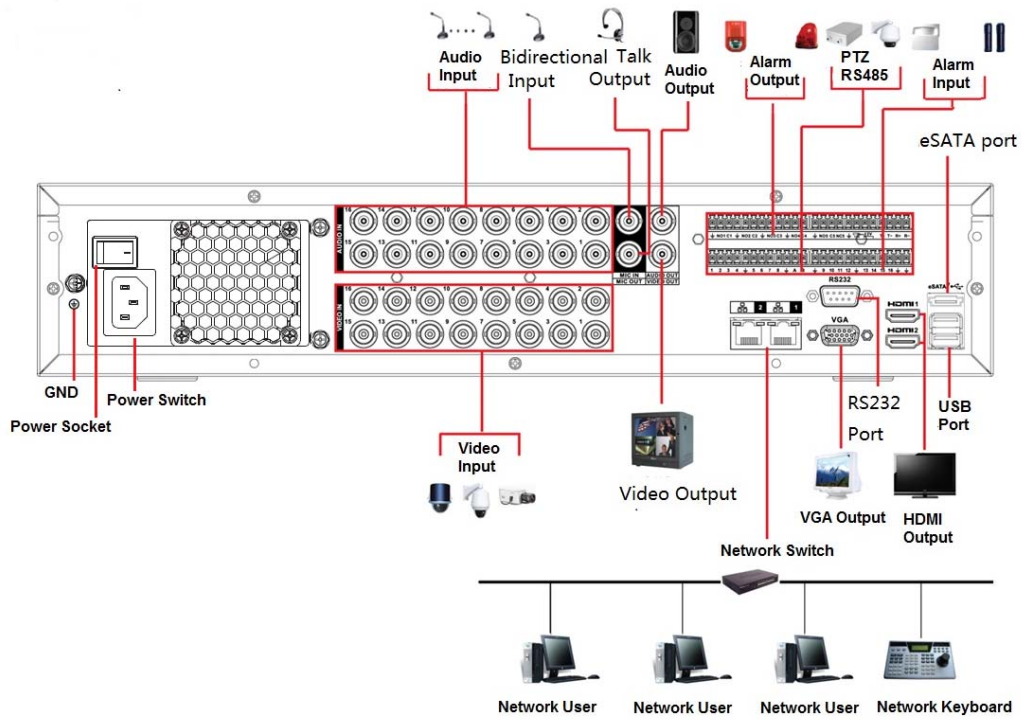

Figure 2-3

2.4 Remote Control

The remote control interface is shown as in Figure 2-4.

Please note remote control is not our standard accessory and it is not included in the accessory bag.

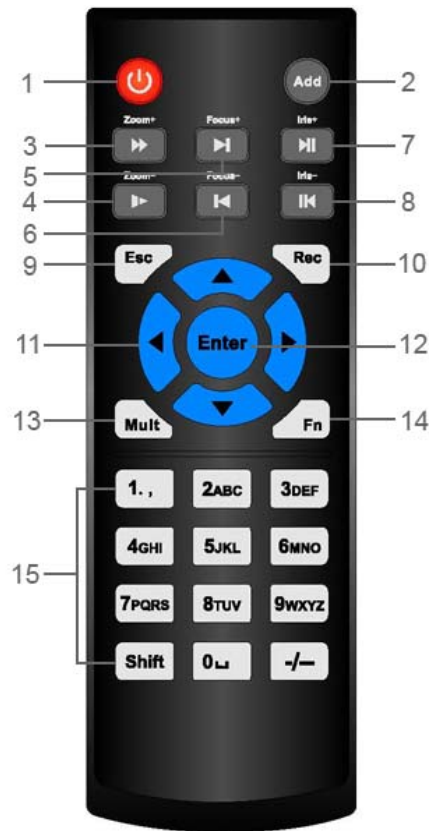





Figure 2-4

Serial Number	Name	Function
1	Power button	Click it to boot up or shut down the device.
2	Address	Click it to input device number, so that you can control it.
3	Forward	Various forward speeds and normal speed playback.
4	Slow play	Multiple slow play speeds or normal playback.
5	Next record	In playback mode, playback the next video.
6	Previous record	In playback mode, playback the previous video.
7	Play/Pause	In pause mode, click this button to realize normal playback.
		In normal playback click this button to pause playback.
		In real-time monitor mode, click this button to enter video search menu.
	Reverse/pause	Reverse playback pause mode,

8		click this button to realize normal playback.
		In reverse playback click this button to pause playback.
9	Esc.	Go back to previous menu or cancel current operation (close upper interface or control)
10	Record	Start or stop record manually In record interface, working with the direction buttons to select the record channel. Click this button for at least 1.5 seconds, system can go to the Manual Record interface.
11	Direction keys	Switch current activated control, go to left or right. In playback mode, it is to control the playback process bar. Aux function(such as switch the PTZ menu)
12	Enter /menu key	go to OK button go to the menu
13	Multiple-window switch	Switch between multiple-window and one-window.
14	Fn	In 1-ch monitor mode: pop up assistant function: PTZ control and Video color.
		Switch the PTZ control menu in PTZ control interface.
		In motion detection interface, working with direction keys to complete setup.
		In text mode, click it to delete character.
15	0-9 number key	Input password, channel or switch channel.
		Shift is the button to switch the input method.

2.5 Mouse Control

<p>Left click mouse</p>	<p>System pops up password input dialogue box if you have not logged in.</p> <p>In real-time monitor mode, you can go to the main menu.</p> <p>When you have selected one menu item, left click mouse to view menu content.</p> <p>Implement the control operation.</p> <p>Modify checkbox or motion detection status.</p> <p>Click combo box to pop up drop down list</p> <p>In input box, you can select input methods. Left click the corresponding button on the panel you can input numeral/English character (small/capitalized). Here ← stands for backspace button. _ stands for space button.</p> <p>In English input mode: _stands for input a backspace icon and ← stands for deleting the previous character.</p> <div style="display: flex; justify-content: space-around; align-items: center;">   </div> <p>In numeral input mode: _ stands for clear and ← stands for deleting the previous numeral.</p> <p>When input special sign, you can click corresponding numeral in the front panel to input. For example, click numeral 1 you can input“/” , or you can click the numeral in the on-screen keyboard directly.</p> <div style="text-align: center;">  </div>
<p>Double left click mouse</p>	<p>Implement special control operation such as double click one item in the file list to playback the video.</p> <p>In multiple-window mode, double left click one channel to view in full-window.</p> <p>Double left click current video again to go back to previous multiple-window mode.</p>
<p>Right click mouse</p>	<p>In real-time monitor mode, DVR pops up shortcut menu. For different series product, the shortcut menu displayed contents may vary.</p> <p>Exit current menu without saving the modification.</p>

Press middle button	In numeral input box: Increase or decrease numeral value.
	Switch the items in the check box.
	Page up or page down
Move mouse	Select current control or move control
Drag mouse	Select motion detection zone
	Select privacy mask zone.

2.6 Virtual Keyboard & Front Panel

2.6.1 Virtual Keyboard

The system supports two input methods: numeral input and English character (small and capitalized) input.

Move the cursor to the text column, the text is shown as blue, input button pops up on the right. Click that button to switch between numeral input and English input (capitalized and small), Use > or < to shift between small character and capitalized character.

2.6.2 Front Panel

Move the cursor to the text column. Click Fn key and use direction keys to select number you wanted. Please click enter button to input.

3 Installation and Connections

Note: All the installation and operations here should conform to your local electric safety rules.

3.1 Check Unpacked DVR

When you receive the DVR from the forwarding agent, please check whether there is any visible damage. The protective materials used for the package of the DVR can protect most accidental clashes during transportation. Then you can open the box to check the accessories.

Please check the items in accordance with the list. Finally you can remove the protective film of the DVR.

Note

Remote control is not a standard accessory and it is not included in the accessory bag.

3.2 About Front Panel and Rear Panel

The model in the front panel is very important; please check according to your purchase order.

The label in the rear panel is very important too. Usually we need you to represent the serial number when we provide the service after sales.

3.3 HDD Installation

3.3.1 HDD Calculation

Calculate total capacity needed by each DVR according to video recording (video recording type and video file storage time).

Step 1: According to Formula (1) to calculate storage capacity q_i that is the capacity of each channel needed for each hour, unit Mbyte.

$$q_i = d_i \div 8 \times 3600 \div 1024 \quad (1)$$

In the formula: d_i means the bit rate, unit Kbit/s

Step 2: After video time requirement is confirmed, according to Formula (2) to calculate the storage capacity m_i , which is storage of each channel needed unit Mbyte.

$$m_i = q_i \times h_i \times D_i \quad (2)$$

In the formula:

h_i means the recording time for each day (hour)

D_i means number of days for which the video shall be

kept

Step 3: According to Formula (3) to calculate total capacity (accumulation) q_T that is needed for all channels in the DVR during **scheduled video recording**.

$$q_T = \sum_{i=1}^c m_i \quad (3)$$

In the formula: c means total number of channels in one DVR

Step 4: According to Formula (4) to calculate total capacity (accumulation) q_T that is needed for all channels in DVR during **alarm video recording (including motion detection)**.

$$q_T = \sum_{i=1}^c m_i \times a\% \quad (4)$$

In the formula: $a\%$ means alarm occurrence rate

You can refer to the following sheet for the file size in one hour per channel. (All the data listed below are for reference only.)

Bit stream size (max)	File size	Bit stream size (max)	File size
96K	42M	128K	56M
160K	70M	192K	84M
224K	98M	256K	112M
320K	140M	384K	168M
448K	196M	512K	225M
640K	281M	768K	337M
896K	393M	1024K	450M
1280K	562M	1536K	675M
1792K	787M	2048K	900M
3072Kbps	1350M	4096K	1800M
6144Kbps	2700M	8192Kbps	3600M

Note

- All information listed in the above sheet for reference only. We are not reliable for any damage or loss resulting from it.
- For the space marked by the HDD manufacturer, 1K=1000Bytes, while for the computer OS, 1K=1024Bytes. So, the space recognized by the computer system is less than the marked space on the HDD. Please pay attention to it.
- All HDD space marked by the HDD manufacturer is shown as below: 1T=1000G, 1G=1000M, 1M=1000K, 1K=1000Bytes.
- All HDD space marked by the HDD manufacturer shall become the computer OS space after the corresponding calculation. For example:
 1T (marked by the HDD manufacturer) = 1000G / (1.024*1.024*1.024) = 931G (OS space),
 500G = 500G / (1.024*1.024*1.024) = 465G

3.3.2 HDD Installation



Important

Shut down the device and then unplug the power cable before you open the case to replace the HDD!

All figures listed below for reference only!

This series DVR has 1 to 8 HDDs (no limitation for capacity). Please use HDD of 7200rpm or higher. Usually we do not recommend the HDD for the PC. You can refer to the Appendix for recommended HDD brand.

Please follow the instructions listed below to install hard disk.



① Loosen the screws of the upper cover and side panel. Remove the cover.



② Fix the HDD(s) on the bracket. Remove the top bracket if you want to install HDD to the bottom bracket.

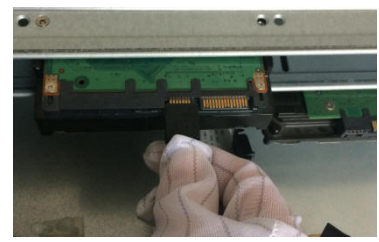

③ Connect the one end of the HDD cable to the HDD.



④ Connect the other end of the HDD cable to the mainboard.

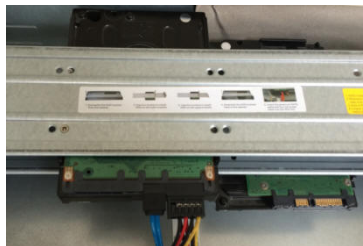

⑤ Connect the power cable to the HDD.



⑥ Put the cover back and fix the screws to secure firmly.

Important:

If the HDD amount is less than four, you do not need to install the HDD bracket.

When there is a bracket, please make sure the installation direction of HDDs is the same.

3.3.2.1 The Removable Front Panel 2U Series

This series DVR max supports 8 SATA HDDs. Please use HDD of 7200rpm or higher.



1. Turn the key into the hole in the front panel.



2. Open the front panel.



3. Put the HDD to the slot and adjust the handle to secure it.



4. Put the front panel back and use the key to fix firmly.

HDD Handle Installation



1. Line up the handle to the HDD side (without the interface)



2. Use the screwdriver to fix the handle on the HDD.

3.3.3 Rack Installation

The DVR occupies 1.5U/2U rack units of vertical rack space.

- Use twelve screws to fix the unit
- Please make sure the indoor temperature is below 35°C (95°F).
- Please make sure there is 15cm (6 inches) space around the device to guarantee sound ventilation.
- Please install from the bottom to the top.
- If there are more accessories connected in the rack, please take precaution measures in case the rack power is overload.

3.4 Connecting Power Supply

Please check input voltage and device power button match or not.

We recommend you use UPS to guarantee steady operation, DVR life span, and other peripheral equipment operation such as cameras.

3.5 Connecting Video Input and Output Devices

3.5.1 Connecting Video Input

The video input interface is BNC. The input video format includes: PAL/NTSC BNC(1.0V_{P-P}, 75Ω.)

The video signal should comply with your national standards.

The input video signal shall have high SNR, low distortion; low interference, natural color and suitable lightness.

Guarantee the stability and reliability of the camera signal:

The camera shall be installed in a cool, dry place away from direct sunlight, inflammable, explosive substances and etc.

The camera and the DVR should have the same grounding to ensure the normal operation of the camera.

Guarantee stability and reliability of the transmission line

Please use high quality, sound shielded BNC. Please select suitable BNC model according to the transmission distance.

If the distance is too long, you should use twisted pair cable, and you can add video compensation devices or use optical fiber to ensure video quality.

You should keep the video signal away from the strong electromagnetic interference, especially the high tension current.

Keep connection lugs in well contact

The signal line and shielded wire should be fixed firmly and in well connection. Avoid dry joint, lap welding and oxidation.

3.5.2 Connecting Video Output

Video output includes a BNC (PAL/NTSC1.0V_{P-P}, 75Ω) output, a VGA output and HDMI output. System supports BNC, VGA and HDMI output at the same time.

When you are using pc-type monitor to replace the monitor, please pay attention to the following points:

- To defer aging, do not allow the pc monitor to run for a long time.
- Regular demagnetization will keep device maintain proper status.
- Keep it away from strong electromagnetic interference devices.

Using TV as video output device is not a reliable substitution method. You also need to reduce the working hour and control the interference from power supply and other devices. The low quality TV may result in device damage.

3.6 Connecting Audio Input & Output, Bidirectional Audio

3.6.1 Audio Input

These series products audio input port adopt BNC port.

Due to high impedance of audio input, please use active sound pick-up.

Audio transmission is similar to video transmission. Try to avoid interference, dry joint, loose contact and it shall be away from high tension current.

3.6.2 Audio Output

The audio output signal parameter is usually over 200mv 1K Ω (BNC or RCA). It can directly connect to low impedance earphone, active sound box or amplifier-drive audio output device.

If the sound box and the pick-up cannot be separated spatially, it is easy to arouse squeaking. In this case you can adopt the following measures:

- Use better sound pick-up with better directing property.
- Reduce the volume of the sound box.
- Using more sound-absorbing materials in decoration can reduce voice echo and improve acoustics environment.
- Adjust the layout to reduce happening of the squeaking.

3.7 Alarm Input and Output Connection

Please read the followings before connecting.

1. Alarm input

- a. Please make sure alarm input mode is grounding alarm input.
- b. Grounding signal is needed for alarm input.
- c. Alarm input needs the low level voltage signal.
- d. Alarm input mode can be either NC (normal Open) or NO (Normal Close)
- e. When you are connecting two DVRs or you are connecting one DVR and one other device, please use a relay to separate them,

2. Alarm output

The alarm output port should not be connected to high power load directly (It shall be less than 1A) to avoid high current which may result in relay damage. Please use the co contactor to realize the connection between the alarm output port and the load.

3. How to connect PTZ decoder

- a. Ensure the decoder has the same grounding with DVR, otherwise you may not control the PTZ. Shielded twisted wire is recommended and the shielded layer is used to connect to the grounding.
- b. Avoid high voltage. Ensure proper wiring and some thunder protection measures.
- c. For too long signal wires, 120 Ω should be parallel connected between A, B lines on the far end to reduce reflection and guarantee the signal quality.
- d. "485 A, B" of DVR cannot parallel connect with "485 port" of other device.
- e. The voltage between of A, B lines of the decoder should be less than 5v.

- Please parallel connect COM end and GND end of the alarm detector (Provide external power to the alarm detector).
- Please parallel connect the Ground of the DVR and the ground of the alarm detector.
- Please connect the NC port of the alarm sensor to the DVR alarm input(ALARM)
- Use the same ground with that of DVR if you use external power to the alarm device.

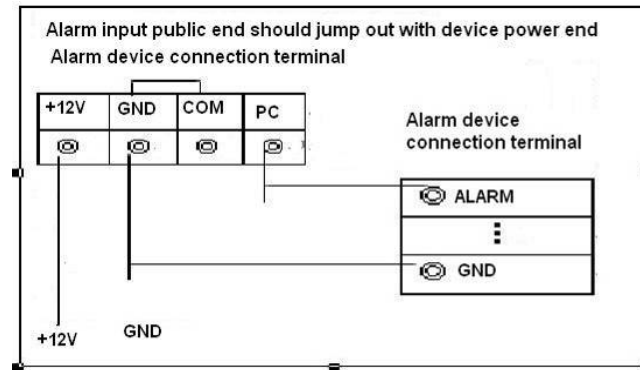

Figure 3-2

3.7.3 Alarm Output Port

- Provide external power to external alarm device.
- To avoid overloading, please read the following relay parameters sheet carefully.
- RS485 A/B cable is for the A/B cable of the PTZ decoder.
- T+,T-,R+,R- are four-wire double duplex RS485 port.
T+ T-: output wire
R+ R-: input wire

Relay Specification

Model:	JRC-27F	
Material of the touch	Silver	
Rating (Resistance Load)	Rated switch capacity	30VDC 2A, 125VAC 1A
	Maximum switch power	125VA 160W
	Maximum switch voltage	250VAC, 220VDC
	Maximum switch current	1A
Insulation	Between touches with same polarity	1000VAC 1minute
	Between touches with different polarity	1000VAC 1minute
	Between touch and winding	1000VAC 1minute
Surge voltage	Between touches with same polarity	1500V (10×160us)
Length of open time	3ms max	

Length of close time	3ms max	
Longevity	Mechanical	50×106 times (3Hz)
	Electrical	200×103 times (0.5Hz)
Temperature	-40°C ~+70°C	

3.8 RS485

When the DVR receives a camera control command, it transmits that command up the coaxial cable to the PTZ device. RS485 is a single-direction protocol; the PTZ device can't return any data to the unit. To enable the operation, connect the PTZ device to the RS485 (A,B) input on the DVR.

Since RS485 is disabled by default for each camera, you must enable the PTZ settings first. This series DVRs support multiple protocols such as Pelco-D, Pelco-P.

To connect PTZ devices to the DVR:

1. Connect RS485 A,B on the DVR rear panel.
2. Connect the other end of the cable to the proper pins in the connector on the camera.
3. Please follow the instructions to configure a camera to enable each PTZ device on the DVR.

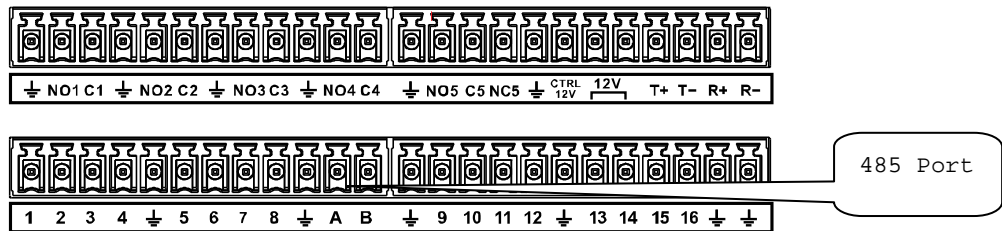

Figure 3-3

3.9 Other Interfaces

There are still other interfaces on the DVR, such as USB port.

4 Overview of Navigation and Controls

4.1 Initial Settings

4.1.1 Boot up

Before the boot up, please make sure:

- The rated input voltage matches the device power on-off button. Please make sure the power wire connection is OK. Then click the power on-off button.
- Always use the stable current, if necessary UPS is a best alternative measure.

Please follow the steps listed below to boot up the device.

- Connect the device to the monitor and then connect a mouse.
- Connect power cable.
- Click the power button at the front or rear panel and then boot up the device. After device booted up, the system is in multiple-channel display mode by default.

4.1.2 Set Password

For your own safety, please set your administrator password after your first login.

After system booted up, you can see the following interface if it is your first login or you have restored default setup. See Figure 4-1. Please input a password and then input again to set a new password.

- You can set security questions here to reset the password in case you forgot. System supports customized setup. Please note you need to set two security questions at the same time. When you reset the password, you need to answer these two security questions too.
- For reset information, please refer to chapter 4.1.3.

The screenshot shows a dark-themed 'ADMIN SECURITY' window. At the top, there is a title bar with the text 'ADMIN SECURITY'. Below the title bar, there are several input fields: 'User Name' with a dropdown menu showing 'admin', 'Enter Password' with a masked input field, 'Confirm Password' with a masked input field, and 'Secure Questions (Optional)'. Under 'Secure Questions', there are two questions: 'Question 1' with a dropdown menu showing 'What's your favorite pet?' and 'Question 2' with a dropdown menu showing 'What's your first car model?'. Each question has an 'Answer' field below it. At the bottom of the window, there is an 'OK' button.

Figure 4-1

Click OK button, system pops up the following interface. See Figure 4-2.
Click OK button to exit.



Figure 4-2

4.1.3 Reset Password

Once you forgot password, you can answer the security questions you set in chapter 4.1.2 to reset the password.

In login interface, click . See Figure 4-3.

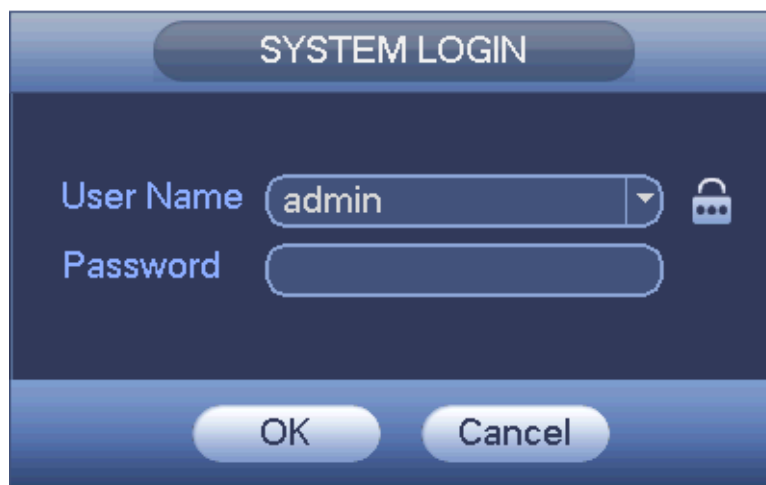

Figure 4-3

System pops up the following dialogue box, please answer the security questions and then input the new password twice. See Figure 4-4.

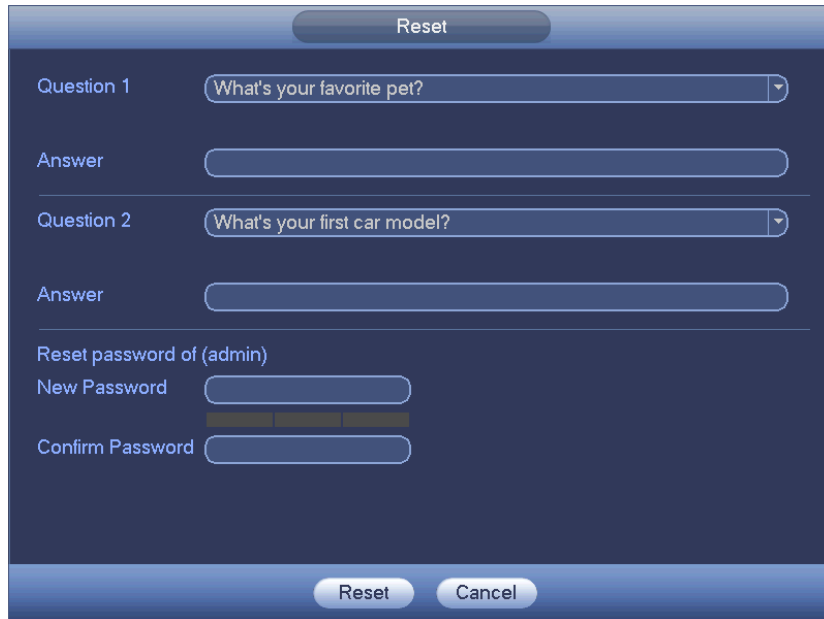

Figure 4-4

4.2 Startup Wizard and Login

Important

From main menu->Setting->System->General, you can enable/disable Startup wizard function.

After you successfully set the password, it goes to startup wizard.

Click Cancel/Next button, you can see system goes to login interface.

Tips

Check the box Startup button here, system goes to startup wizard again when it boots up the next time.

Cancel the Startup button, system goes to the login interface directly when it boots up the next time.



Figure 4-5

Click Cancel button or Next Step button, system goes to login interface. See Figure 4-6.

System consists of three accounts:

- **Username:** admin. **Password:** You set in chapter 4.1.2.
- **Username:** 888888. **Password:** 888888. (administrator, local only)
- **Username:** default. **Password:** default (hidden user). Hidden user “default” is for system interior use only and can not be deleted. When there is no login user, hidden user “default” automatically login. You can set some rights such as monitor for this user so that you can view some channel view without login.

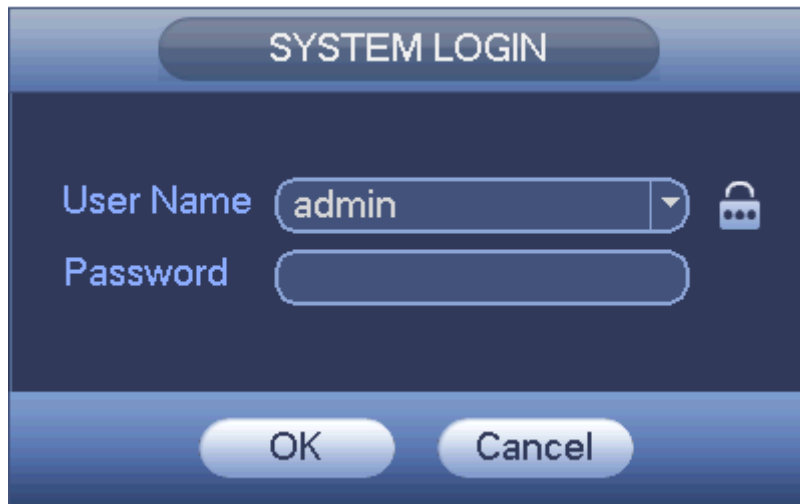

Figure 4-6



Caution

- Please reboot the device or wait for 30 minutes if your account has been locked. You can go to main menu->Setting->Event->Abnormality->User->Illegal login to set customized account lock time.

After input corresponding user name and password, you can click OK button. System goes to the startup wizard.

4.2.1 General

Tips:

From main menu->Setting->System->General, you can also go to the following interface.

4.2.1.1 General

Click OK button, you can go to General interface. See Figure 4-7.

- Device ID: Please input a corresponding device name here.
- Device No: Here you can set device number.
- Language: System supports various languages: Chinese (simplified), Chinese (Traditional), English, Italian, Japanese, French, Spanish (All languages listed here are optional. Slight difference maybe found in various series.)
- Video standard: There are two formats: NTSC and PAL.
- HDD full: Here is for you to select working mode when hard disk is full. There are two options: stop recording or rewrite. If current working HDD is overwritten or the current

HDD is full while the next HDD is no empty, then system stops recording, If the current HDD is full and then next HDD is not empty, then system overwrites the previous files. Please note, DVR will not overwrite the locked files. Please refer to chapter 4.10.8 to lock or unlock a file.

- Pack duration: Here is for you to specify record duration. There are two ways for you to set.
- ✧ Time length: It is to pack according to time. The value ranges from 1 to 60 minutes. Default value is 60 minutes.
- ✧ File length: It is to pack according to file length. The default setup is 1024M. The value ranges from 128M to 2048M.
- Instant playback: It is to set playback time you can view in the preview interface. The value ranges from 5 to 60 minutes.
- Auto logout: Here is for you to set auto logout interval once login user remains inactive for a specified time. Value ranges from 0 to 60 minutes.
- IPC Time Sync: You can input an interval here to synchronize the DVR time and IPC time.
- Navigation bar: Check the box here, system displays the navigation bar on the interface.
- Startup wizard: Once you check the box here, system will go to the startup wizard directly when the system restarts the next time. Otherwise, it will go to the login interface.
- Mouse sensitivity: You can set double click speed via dragging the slide bard. You can Click Default button to restore default setup.



Figure 4-7

4.2.1.2 Date and Time

The interface is shown as in Figure 4-8.

- Date format: There are three types: YYYY-MM-DD: MM-DD-YYYY or DD-MM-YYYY.
- Date separator: There are three denotations to separate date: dot, beeline and solidus.
- DST: Here you can set DST time and date. Here you can set start time and end time by setting corresponding week setup or by setting corresponding date setup.
- NTP: It is to set NTP server information. Check the NTP box to enable this function.
- ✧ Host IP: Input the server IP that installed the NTP server.
- ✧ Manual update: Click it, you can sync DVR time with the NTP server manually.
- ✧ Port: System supports TCP transmission only. The port value is 123.
- ✧ Interval: It is to set the sync time interval between the DVR and the NTP server. The value ranges from 0 to 65535 minutes.



Figure 4-8

4.2.1.3 Holiday

Holiday setup interface is shown as in Figure 4-9. Click Add new holiday button, you can input new holiday information. See Figure 4-10. Here you can set holiday name, repeat mode and start/end time.

Note

- When you enable Holiday settings and schedule setup at the same time, holiday setting has the priority. If the selected day is a holiday, then system records as you

set in holiday setting. If it is not a holiday, system records as you set in Schedule interface. Please note

- Please note, there is no year setup on the holiday setup. For example, if you set 30th Oct, 2012 as a holiday, then the date of 30th Oct in each year will be set as a holiday.

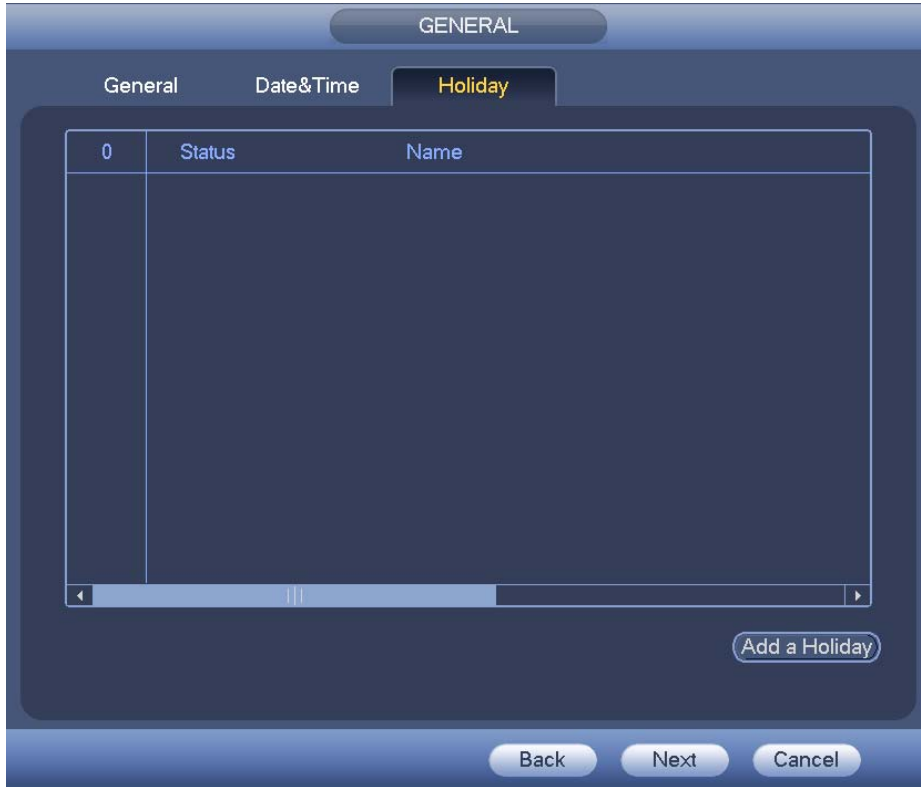

Figure 4-9



Figure 4-10

4.2.2 Network

Tips:

From main menu->Setting->Network->TCP/IP, you can also go to the following interface.

Click Next button, you can go to network interface. See Figure 4-11.

- **Network Mode:** Includes multiple access, fault tolerance, and load balancing. **Please note the network mode is not for product of single-Ethernet card.**

- ◇ **Multiple-address mode:** eth0 and eth1 operate separately. You can use the services such as HTTP, RTP service via eth0 or the eth1. Usually you need to set one default card (default setup is eth0) to request the auto network service from the device-end such as DHCP, email, FTP and etc. In multiple-address mode, system network status is shown as offline once one card is offline.
- ◇ **Network fault-tolerance:** In this mode, device uses bond0 to communicate with the external devices. You can focus on one host IP address. At the same time, you need to set one master card. Usually there is only one running card (master card). System can enable alternate card when the master card is malfunction. The system is shown as offline once these two cards are both offline. Please note these two cards shall be in the same LAN.
- ◇ **Load balance:** In this mode, device uses bond0 to communicate with the external device. The eth0 and eth1 are both working now and bearing the network load. Their network load are general the same. The system is shown as offline once these two cards are both offline. Please note these two cards shall be in the same LAN.

- **Default Network Card:** Please select eth0/eth1/bond0(optional) after enable multiple-access function
- **Main Network Card:** Please select eth0/eth1 (optional).after enable multiple access function.

Note: Some series support the above three configurations and supports functions as multiple-access, fault-tolerance and load balancing.

- **IP Version:** There are two options: IPv4 and IPv6. Right now, system supports these two IP address format and you can access via them.
- **MAC address:** The host in the LAN can get a unique MAC address. It is for you to access in the LAN. It is read-only.
- **IP address:** Here you can use up/down button (▲▼) or input the corresponding number to input IP address. Then you can set the corresponding subnet mask the default gateway.
- **Default gateway:** Here you can input the default gateway. Please note system needs to check the validity of all IPv6 addresses. The IP address and the default gateway shall be in the same IP section. That is to say, the specified length of the subnet prefix shall have the same string.
- **DHCP:** It is to auto search IP. When enable DHCP function, you can not modify IP/Subnet mask /Gateway. These values are from DHCP function. If you have not enabled DHCP function, IP/Subnet mask/Gateway display as zero. You need to

disable DHCP function to view current IP information. Besides, when PPPoE is operating, you can not modify IP/Subnet mask /Gateway.

- MTU: It is to set MTU value of the network adapter. The value ranges from 1280-7200 bytes. The default setup is 1500 bytes. Please note MTU modification may result in network adapter reboot and network becomes off. That is to say, MTU modification can affect current network service. System may pop up dialog box for you to confirm setup when you want to change MTU setup. Click OK button to confirm current reboot, or you can click Cancel button to terminate current modification. Before the modification, you can check the MTU of the gateway; the MTU of the DVR shall be the same as or is lower than the MTU of the gateway. In this way, you can reduce packets and enhance network transmission efficiency.

The following MTU value is for reference only.

- ◇ 1500: Ethernet information packet max value and it is also the default value. It is the typical setup when there is no PPPoE or VPN. It is the default setup of some router, switch or the network adapter.
- ◇ 1492: Recommend value for PPPoE.
- ◇ 1468: Recommend value for DHCP.
- Preferred DNS server: DNS server IP address.
- Alternate DNS server: DNS server alternate address.



Figure 4-11

4.2.3 P2P

Tips:

From main menu->Setting->Network->P2P, you can also go to the following interface.

Click Next button, you can set P2P function. See Figure 4-12.

You can add a device via the client on the cellphone or the platform.

- You can use your cell phone to scan the QR code and add it to the cell phone client.
- Go to the P2P management platform, via the SN from scanning the QR code, you can access the device in the WAN. Please refer to the P2P operation manual included in the resources CD.





Figure 4-12

Here we use cell phone APP to continue.

- Step 1 Use cell phone to scan the QR code and download the APP.
- Step 2 After installation, run the APP and Live Preview, enter the main interface. Now you can add device to the APP.



1. Open App; tap  to go to the Live preview.
2. Tap  at the top left corner, you can see the main menu.
3. Tap Device manager button, you can use several modes (P2P/DDNS/IP and etc.) to add the device. Click  to save current setup. Tap Start Live preview to view all-channel video from the connected device. See Figure 4-13.

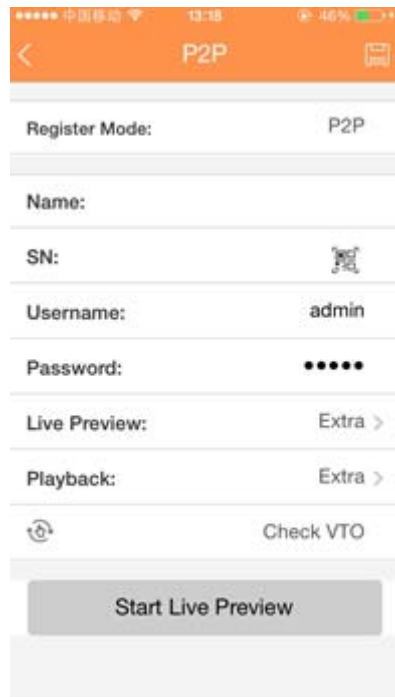

Figure 4-13

4.2.4 Registration

Note

You can only see the registration interface if you have set IP channel (Chapter 4.17.3). The DVR supports ONVIF standard protocol.

Tips

From the main menu->Setting->Camera->Registration, or on the preview window and then right click mouse and then select Camera Registration, you can go to the following interface.

Click Next button, you can go to the Camera registration interface to add the camera to the corresponding channel. See Figure 4-14.

Please note you can not see the following interface if there is no digital channel. You can go to Main menu->Setting->Camera->Channel type to set IP channel first.

- IP search: Click it to search IP address. It includes device IP address, port, device name, manufacturer, type. Use your mouse to click the item name, you can refresh display order. Click IP address, system displays IP address from small to large. Click IP address again, you can see icon, system displays IP address from large to small. You can click other items to view information conveniently. For the network device already added to the device, you can see there is a small icon "*" after the SN in case there is repeatedly add operation.
- Add: Click it to connect to the selected device and add it to the Added device list. Support Batch add.

You can see the corresponding dialogue box if all digital-channel has connected to the front-end.

System can not add new device if the device you want to add has the same IP and TCP port as the device in the list.





- Show filter: You can use it to display the specified devices from the added device.
- ✧ None: There is a filter. DVR displays all devices by default.
- ✧ IPC: You can only view all network cameras.
- ✧ DVR: You can view all storage devices such as DVR, NVR.
- Edit: Click button  or double click a device in the list, you can change channel setup.
- Delete: Please select one device in the Added device list and then click  to remove.
- Status:  means connection is OK and  means connection failed.
- Delete: Select a device on the Added device list, click Delete button, system disconnect device first and then remove its name from the list.
- Manual add: Click it to add the IPC manually. The port number is 37777. The default user name is admin and password is admin.





Figure 4-14

Click the Manual Add button; you can go to the following interface. See Figure 4-15.

Channel number: The dropdown list here displays unconnected channel number. You can go to Figure 4-14 to set remote channel connection.

Please note:

- This series product supports the IPC from many popular manufactures such as Sony, Hitachi, Axis, Samsung, Dynacolor, Arecont, and Onvif.
- System default IP address is 192.168.0.0 if you do not input IP address. System will not add current IP address.
- You can not add two or more devices in the Manual Add interface (Figure 4-15.). Click OK button, system connects to the corresponding front-end device of current channel on the interface.
-  means connection successful.  means connection failed.



The image shows a 'Manual Add' dialog box with a dark blue background and light blue text. It contains several input fields: 'Channel' (dropdown menu with '15'), 'Manufacturer' (dropdown menu with 'Private'), 'IP Address' (text box with '192.168.0.0'), 'TCP Port' (text box with '37777'), 'User Name' (text box with 'admin'), 'Password' (text box with six dots), 'Remote Channel' (text box with '1'), and 'Decoder Buffer' (dropdown menu with 'Default'). At the bottom right, there are 'OK' and 'Cancel' buttons.

Figure 4-15

- Show filter: It is to filter the searched device.
 - None: it is to display all searched devices.
 - IPC: It is to display all cameras.
 - DVR: It is to display all storage devices such as NVR, DVR.
- Change IP:
 - ✧ Click , you can change the information such as IP address, subnet mask, and default gateway, user name, password of the checked device. See Figure 4-16. Click Add button and then click OK, you can add current device to the list,



Figure 4-16

- ✧ You can check several devices at the same time and then click the edit button . See Figure 4-17. Please check Batch modify button and then input start IP, end IP and default gateway. Click Add button and then click OK, you can add devices to the list,



Figure 4-17

- IP Export

System can export the Added device list to your local USB device.

Please insert the USB device and then click the Export button; you can see the following interface. See Figure 4-18.

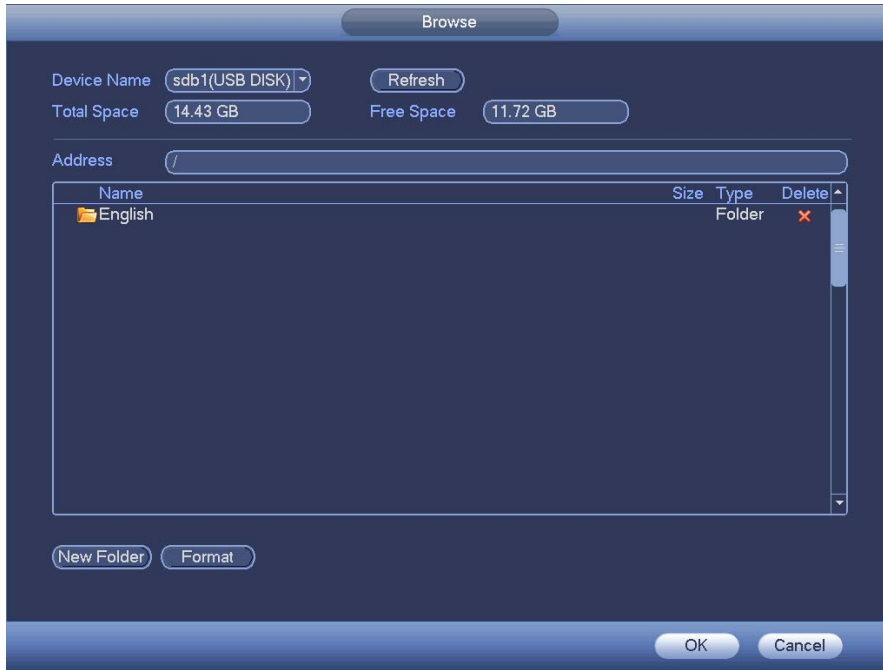

Figure 4-18

Select the directory and then click the OK button. System pops up a dialogue box to remind you successfully exported. Please click OK button to exit.

Note

The exported file extension name is .CVS. The file information includes IP address, port, remote channel number, manufacturer, user name and password.

- IP Import

Click Import button, you can see the following interface. See Figure 4-19.

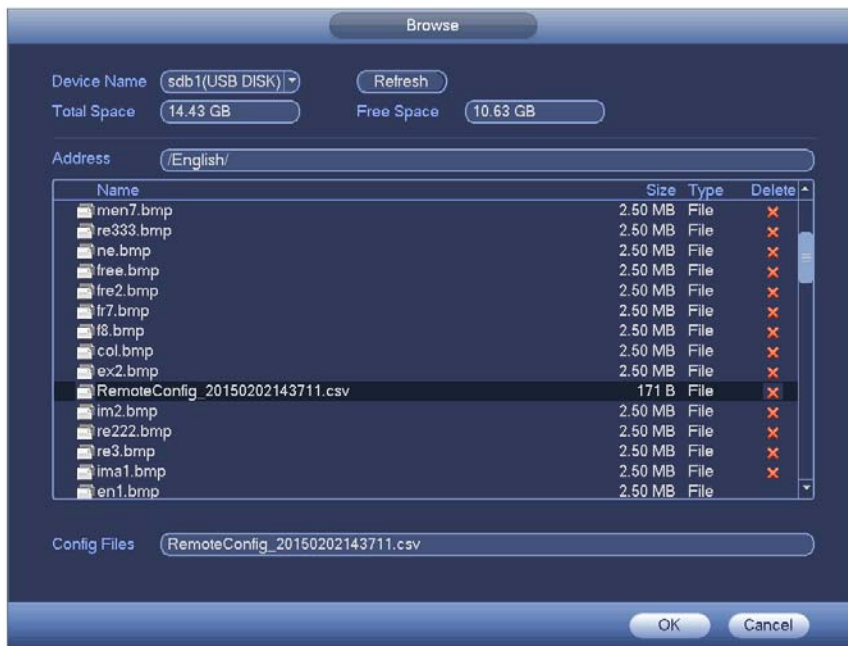

Figure 4-19

Select the import file and then click the OK button. System pops up a dialogue box to remind you successfully exported. Please click OK button to exit.

Note:

If the imported IP has conflicted with current added device, system pops up a dialogue box to remind you. You have two options:

- OK: Click OK button, system uses the imported setup to overlay current one.
- Cancel: Click Cancel button, system adds the new IP setup.



Important

- You can edit the exported .CVS file. **Do not change the file format; otherwise it may result in import failure.**
- Does not support customized protocol import and export.
- The import and export device shall have the same language format.

4.2.5 Encode

Tips

From main menu->Setting->Camera->Encode, you can also go to the following interface.

4.2.5.1 Encode

Click Next button, you can go to Encode interface. See Figure 4-20.

- Channel: Select the channel you want.
- Smart codec: Check the box to enable smart codec function. It can lower bit streams, enhance compression rate, and reduce HDD storage space. Please note this function is for main stream only.
- Type: Please select from the dropdown list. There are three options: regular/motion detect/alarm. You can set the various encode parameters for different record types.
- Compression: System supports H.264H, H.264, H.264B, and MJPEG.
 - ◇ H.264H: It is the High Profile compression algorithm. It has the high encode compression rate. It can achieve high quality encode at low bit stream. Usually we recommend this type.
 - ◇ H.264 is the general compression algorithm.
 - ◇ H.264B is the Baseline algorithm. Its compression rate is low. For the same video quality, it has high bit stream requirements.
- Resolution: It is to set video resolution. The higher the resolution is, the better the video quality is.
- Frame rate: It ranges from 1f/s to 25f/s in NTSC mode and 1f/s to 30f/s in PAL mode.
- Bit rate type: System supports two types: CBR and VBR. In VBR mode, you can set video quality.
- Quality: There are six levels ranging from 1 to 6. The sixth level has the highest image quality.
- Video/audio: You can enable or disable the video/audio.
- Audio format: Please select from the dropdown list. There are three options: G711a/G711u/PCM.

- Audio source: Please select from the dropdown list. There are two options: local/HD AVS. For local mode, the audio signal is from the Audio In port. For HD AVS mode, the audio signal is from the coaxial cable of the camera.
- Audio sampling: It refers to the audio signal sampling times in one second. The higher the rate is, the higher the audio quality is. There are two modes: 8K/16K. The default setup is 8K. HD AVS audio max supports 16K.



Figure 4-20

4.2.5.2 Snapshot

Here you can set snapshot mode, picture size, quality and frequency. See Figure 4-21.

- Snapshot mode: There are two modes: timing and trigger. If you set timing mode, you need to set snapshot frequency. If you set trigger snapshot, you need to set snapshot activation operation.
- Image size: Here you can set snapshot picture size.
- Image quality: Here you can set snapshot quality. The value ranges from 1 to 6.
- Interval: It is for you to set timing (schedule) snapshot interval.

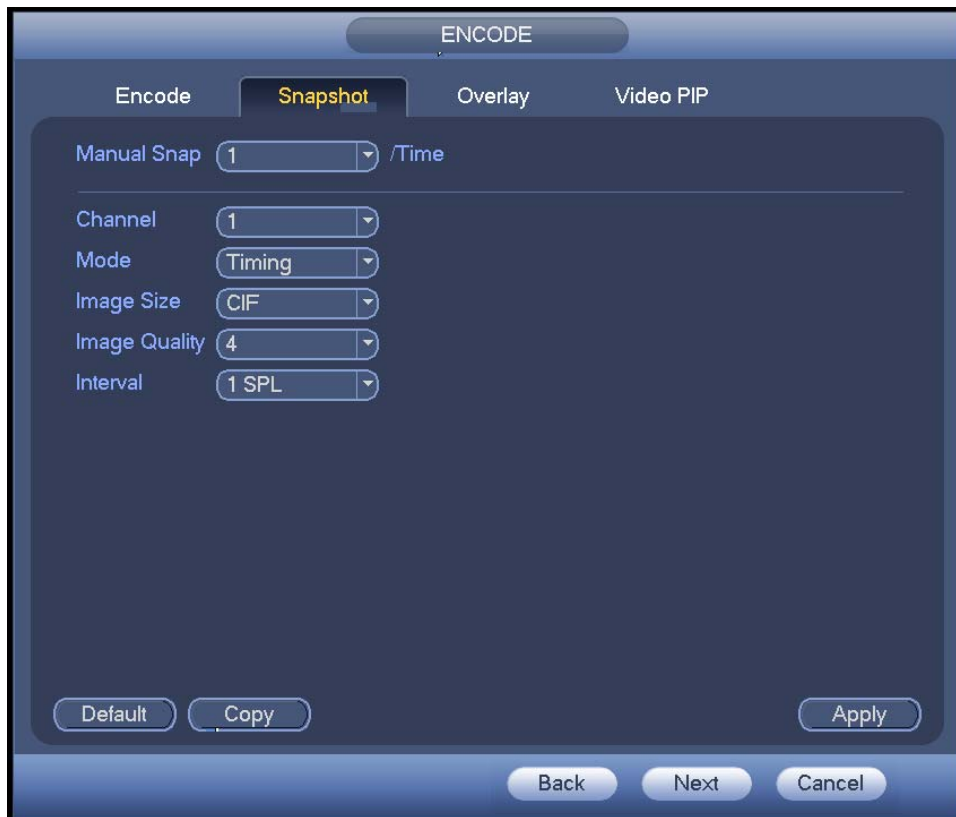

Figure 4-21

4.2.5.3 Overlay

Overlay interface is shown as in Figure 4-22.

- Cover area: Here is for you to set cover area. You can drag you mouse to set proper section size. In one channel video, system max supports 4 zones in one channel.
- Preview/monitor: privacy mask has two types. Preview and Monitor. Preview means the privacy mask zone can not be viewed by user when system is in preview status. Monitor means the privacy mask zone can not be view by the user when system is in monitor status.
- Time display: You can select system displays time or not when you playback. Please click set button and then drag the title to the corresponding position in the screen.
- Channel display: You can select system displays channel number or not when you playback. Please click set button and then drag the title to the corresponding position in the screen.
- Copy: After you complete the setup, you can click Copy button to copy current setup to other channel(s). You can see an interface is shown as in Figure 4-23. You can see current channel number is grey. Please check the number to select the channel or you can check the box ALL. Please click the OK button in Figure 4-23 and Figure 4-22 respectively to complete the setup.

Please highlight icon  to select the corresponding function.



Figure 4-22

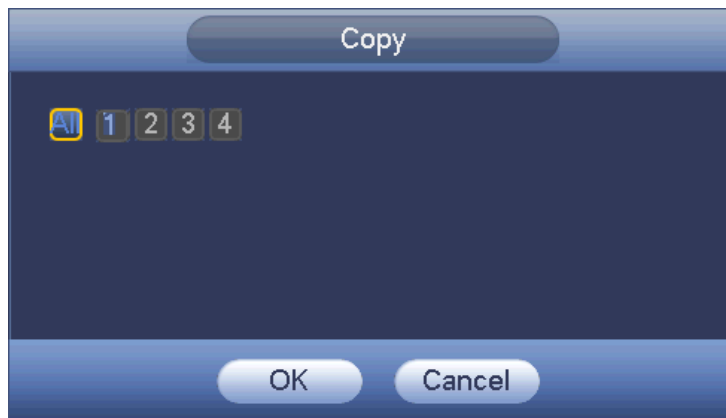

Figure 4-23

4.2.5.4 Video PIP

Click Video PIP button, you can go to Figure 4-24.

PIP (Picture in picture) is to overlay the video from other channel(s) on current channel. It can realize PIP function during the preview or encode process. It is suitable for the realtime surveillance and record search and playback. It is easy for you to manage the video or records of corresponding channels.

When you are setting PIP, each 8 channels can be included in one group. The original channel and the overly channel shall be in the same group.

- P0: It means there is no overlay channel.
- P1: There is one overlay channel.
- P2: There are two overlay channels.

Note:

- You can set two P1 or one P2.

Click Set button, you can use your mouse to set the overlay video to the corresponding position. Drag the mouse to zoom in or zoom out the overlay video.

Click Apply to complete the setup.



Figure 4-24

Note

- The PIP function is about the video collection overlay. For the video already overlaid, it can not be used as the main video to overlay another video. For example, once channel 3 and channel 4 has been overlaid to channel 1, you can not overlay other channel to channel 3 or channel 4.
- For PIP function, there is only audio output from the main video; the overlay channel does not support audio output function.
- The PIP function does not support IVS rule setup.

4.2.6 Schedule

Tips:

From main menu->Setting->Storage->Schedule, you can also go to the following interface.

Click Next button, you can go to Schedule interface. See Figure 4-128.





Note:

You need to have proper rights to implement the following operations. Please make

sure the HDDs have been properly installed.

After the system booted up, it is in default 24-hour regular mode. You can set record type and time in schedule interface.

Please note you need to go to main menu->Setting->System->General->Holiday to set holiday date first, otherwise, there is no holiday setup item.

- Channel: Please select the channel number first. You can select “all” if you want to set for the whole channels.
- ✧ : Sync connection icon. Select icon  of several dates, all checked items can be edited together. Now the icon is shown as .
- ✧ : Click it to delete a record type from one period.
- Record Type: Please check the box to select corresponding record type. There are five types: Regular/MD (motion detect)/Alarm/MD&Alarm/intelligent.
- Week day: There are eight options: ranges from Saturday to Sunday and all.
- Holiday: It is to set holiday setup. Please note you need to go to the General interface (Main Menu->System->General) to add holiday first. Otherwise you can not see this item.
- Pre-record: System can pre-record the video before the event occurs into the file. The value ranges from 1 to 30 seconds depending on the bit stream.
- Redundancy: System supports redundancy backup function. You can highlight Redundancy button to activate this function. Please note, before enable this function, please set at least one HDD as redundant. (Main menu->Setting->Storage->HDD Manager). **Please note this function is null if there is only one HDD.**
- Period setup: Click button  after one date or a holiday, you can see an interface shown as in Figure 4-86. There are five record types: regular, motion detection (MD), Alarm, MD & alarm and intelligent.

Please following the steps listed below to draw the period manually.

- ✧ Select a channel you want to set. See Figure 4-95.



Figure 4-25

- ✧ Set record type. See Figure 4-94.



Figure 4-26

- ✧ Please draw manually to set record period. There are six periods in one day. See Figure 4-27.

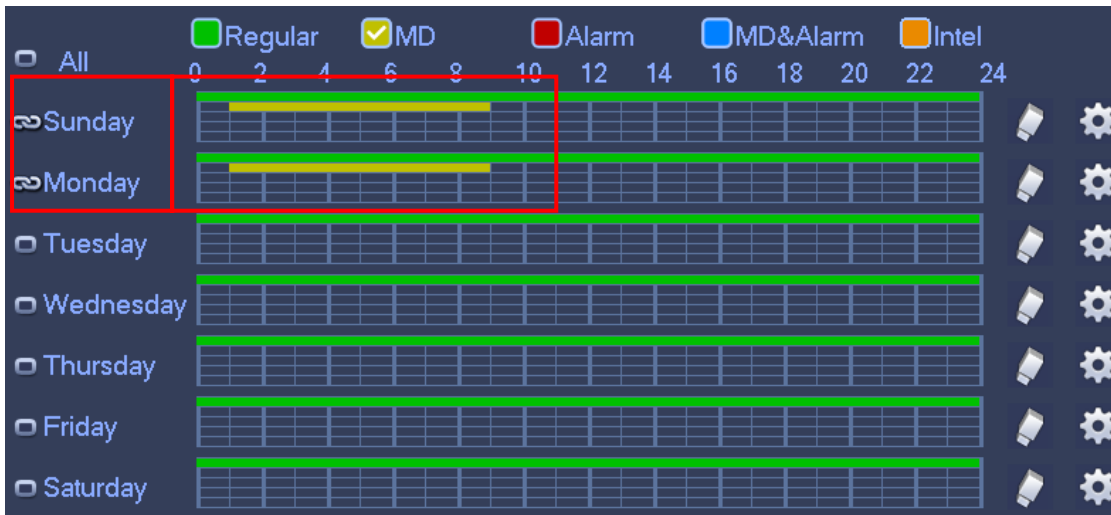



Figure 4-27

Please highlight icon  to select the corresponding function. After completing all the setups please click save button.

There are color bars for your reference. Green color stands for regular recording, yellow color stands for motion detection and red color stands for alarm recording. The blue means the MD and alarm record is valid. Once you have set to record when the MD and alarm occurs, system will not record neither motion detect occurs nor the alarm occurs (That is to say, system only record when motion detect and alarm both occurs.).

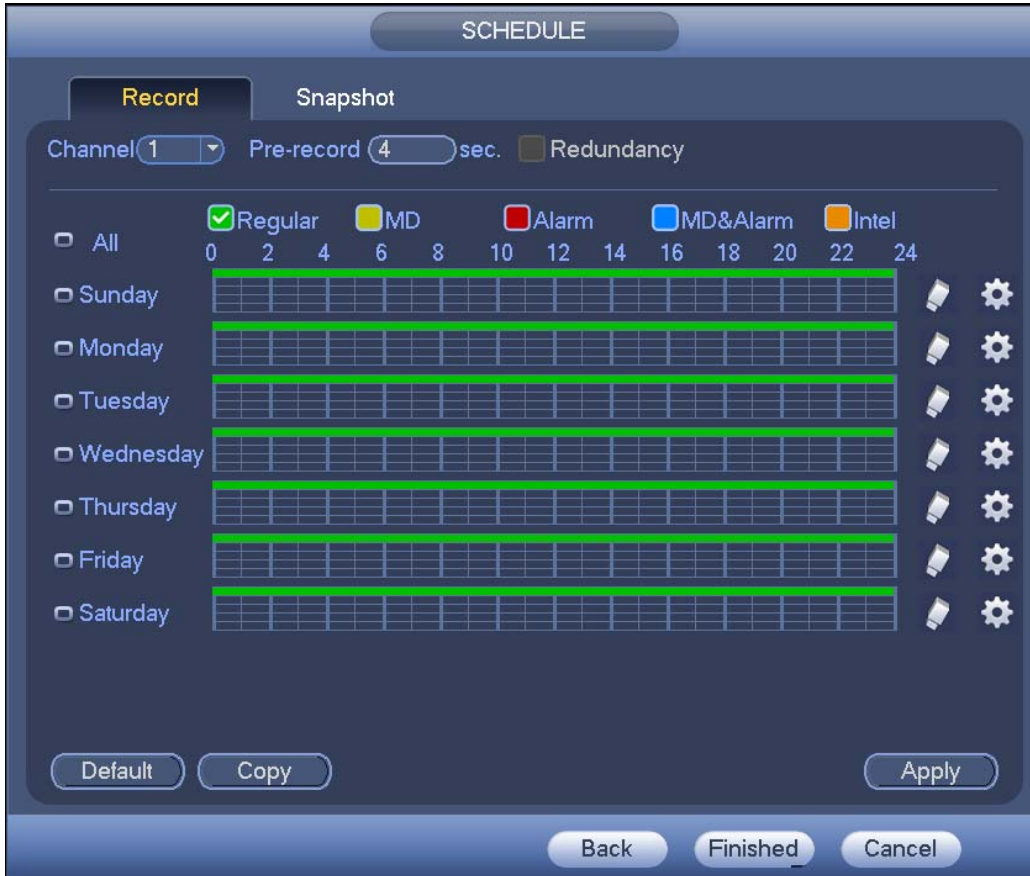

Figure 4-28



Figure 4-29

4.2.6.1 Quick Setup

Copy function allows you to copy one channel setup to another. After setting in channel 1, click Copy button, you can go to interface Figure 4-85. You can see current channel name is grey such as channel 1. Now you can select the channel you want to paste such as channel 5/6/7. If you want to save current setup of channel 1 to all channels, you can click

the first box “ALL”. Click the OK button to save current copy setup. Click the OK button in the Encode interface, the copy function succeeded.

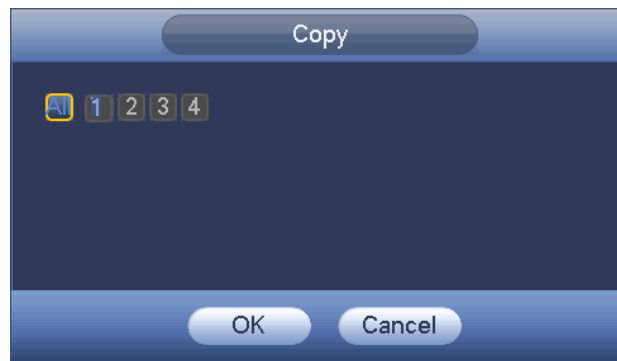

Figure 4-30

4.2.6.2 Redundancy

Redundancy function allows you to memorize record file in several disks. When there is file damage occurred in one disk, there is a spare one in the other disk. You can use this function to maintain data reliability and safety.

- In the main menu, from Setting->Storage-> Schedule, you can highlight redundancy button to enable this function.
- In the main menu, from Main menu->Setting->Storage->HDD Manager, you can set one or more disk(s) as redundant. You can select from the dropdown list. System auto overwrites old files once hard disk is full.

Please note only read/write disk or read-only disk can backup file and support file search function, so you need to set at least one read-write disk otherwise you can not record video.

Note

About redundancy setup:

- If current channel is not recording, current setup gets activated when the channel begin recording the next time.
- If current channel is recording now, current setup will get activated right away, the current file will be packet and form a file, then system begins recording as you have just set.

After you completed all the setups, please click Save button.

Playback or search in the redundant disk.

There are two ways for you to playback or search in the redundant disk.

- Set redundant disk(s) as read-only disk or read-write disk (Main menu->Setting->Storage->HDD Manager)). System needs to reboot to get setup activated. Now you can search or playback file in redundant disk.
- Dismantle the disk and play it in another PC.

Click Finish button, system pops up a dialogue box. Click the OK button, the startup wizard is complete. See Figure 4-31.

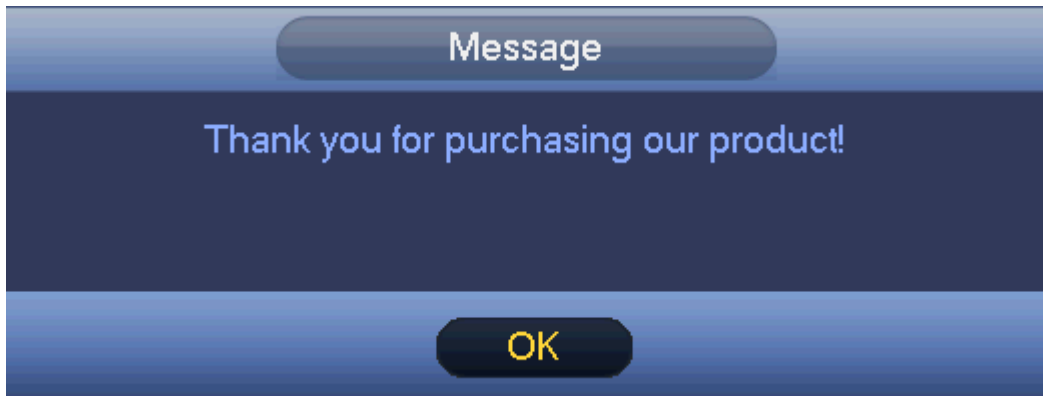

Figure 4-31

4.3 Preview

4.3.1 Preview Window

After you logged in, the system is in live viewing mode. You can see system date, time, channel name and window No. If you want to change system date and time, you can refer to general settings (Main Menu->Setting->System->General). If you want to modify the channel name, please refer to the display settings (Main Menu->Camera->CAM name)

1		Recording status	3		Video loss
2		Motion detection	4		Camera lock

Tips

- Preview drag: If you want to change position of channel 1 and channel 2 when you are previewing, you can left click mouse in the channel 1 and then drag to channel 2, release mouse you can switch channel 1 and channel 2 positions.
- Use mouse middle button to control window split: You can use mouse middle button to switch window split amount.

Please note you can not switch position of one analog channel and one digital channel.

4.3.2 Preview Control

Preview control interface

Move your mouse to the top center of the video of current channel, you can see system pops up the preview control interface. See Figure 4-32 and Figure 4-33. If your mouse stays in this area for more than 6 seconds and has no operation, the control bar automatically hides.



Figure 4-32 Analog Channel



Figure 4-33 Digital Channel

4.3.2.1 Instant playback

It is to playback the previous 5-60 minutes record of current channel.

Please go to the Main menu->Setting->System->General to set instant playback time.

The preview control function has the following features.

- Support preview playback.
 - ✧ In the preview desktop, system can playback previous 5-60 minutes record of current channel. Please go to the Main Menu->General to set instant playback time.
 - ✧ Support drag and play function. You can use your mouse to select any playback start time.
 - ✧ Support playback, pause and exit function.

- ✧ Right now, system does not support slow playback and backward playback function.



You can follow the contents listed below for the operation instruction.

During instant playback interface:

- System supports play, pause, exit and drag function.
- In preview playback mode, system may shield current channel title and record information. When you exit instant playback, you can view the channel title, record information again.
- During preview playback mode, system does not support split and switch function.

4.3.2.2 Digital zoom

It is to zoom in specified zone of current channel. It supports zoom in function in multiple-channel mode. There are two ways for you to zoom in.

- Click button , the button is shown as . Drag the mouse to select a zone, you can zoom in the specified zone. You can drag in any direction you desire.
- Put the mouse at the center of the zone you want to zoom in, and move the mouse, you can zoom in the specified zone. You can drag in any direction you desire.

Right click mouse to cancel zoom and go back to the original interface.

4.3.2.3 Manual record function

It is to backup the video of current channel to the USB device. System can not backup the video of multiple-channel at the same time.

Click button , system begins recording. Click it again, system stops recording. You can find the record file on the flash disk.

4.3.2.4 Manual Snapshot

Click  to snapshot 1-5 times. The snapshot file is saved on the USB device or HDD.

You can go to the Search interface (chapter 4.10) to view.

4.3.2.5 Freeze

Click  to freeze current video.

4.3.2.6 Mute (For analog channel only)

Click to mute. Click again to enable audio function when preview.

Please note this function is for one-window mode only.

4.3.2.7 Bidirectional talk (For digital channel only)

If the connected front-end device supports bidirectional talk function, you can click this

button. Click button  to start bidirectional talk function the icon now is shown as

. Now the rest bidirectional talk buttons of digital channel becomes null too.

Click  again, you can cancel bidirectional talk and the bidirectional talk buttons of

other digital channels become as .

4.3.2.8 Registration (For digital channel only)

It is a shortcut menu. Click it to go to the Registration interface to add/delete remote device or view its corresponding information. Please refer to chapter 4.2.4 for detailed information.

4.3.3 Right-Click Menu

On the preview interface, right click mouse, you can view menu interface shown as in Figure 4-34.

Tips

After you go to the corresponding interface, right click mouse to go back to the upper-level.

- Window split mode: You can select window amount and then select channels.
- Previous screen/next screen: Click it to go to the previous screen/next screen. For example, if you are using 4-split mode, the first screen is displaying the channel 1-4, click Next screen, you can view channel 5-8.
- PTZ: Click it to go to PTZ interface. For detailed operation information, please refer to chapter 4.7.
- Fisheye: It is to set fisheye installation mode and display mode. For detailed operation information, please refer to chapter 4.5.
- Smart track: It is to view the smart track image. For detailed operation information, please refer to chapter 4.15.7.
- Auto focus: Please make sure you connected network camera supports this function. For detailed operation information, please refer to chapter 4.3.6.
- Color setting: Set video corresponding information. For detailed operation information, please refer to chapter 4.3.5.
- Image: Set camera video parameters. For detailed operation information, please refer to chapter 4.17.1.
- Display: Set video output rate. For detailed operation information, please refer to chapter 4.3.8.1.
- Sub port: Click it to switch to HDMI2 port.
- Search: Click it to go to Search interface to search and playback a record file. For detailed operation information, please refer to chapter 4.10.
- Face search: It is to display human face list and view human face record. For detailed operation information, please refer to chapter 4.4.
- Record control: Enable/disable record/snapshot channel. For detailed operation information, please refer to chapter 4.9.
- Alarm output: Enable/disable alarm output function. For detailed operation information, please refer to chapter 4.15.10.
- Camera registration: Click it to go to registration interface. Here you can search and add remote device. For detailed operation information, please refer to chapter 4.2.4.
- Video matrix: Set video matrix tour channel and interval. For detailed operation information, please refer to chapter 4.3.9.2.
- Main menu: Go to system main menu interface.

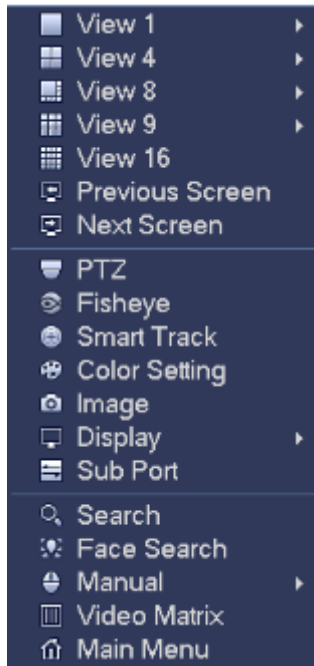

Figure 4-34

4.3.4 Window Switch

System supports 1/4/8/9/16-window (The options here depend on your product channel amount). You can select from the dropdown list. See Figure 4-35.

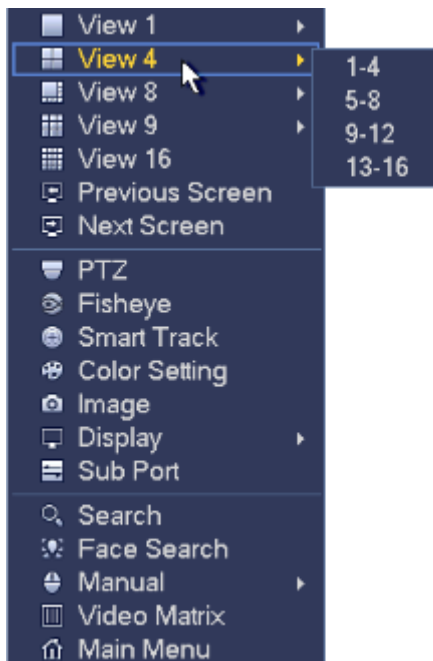

Figure 4-35

4.3.5 Video Color

It is to set analog channel video color.

On the preview window, right click mouse and then select Color, you can view the following interface. See Figure 4-36. Please note the following interface may vary due to different camera series.

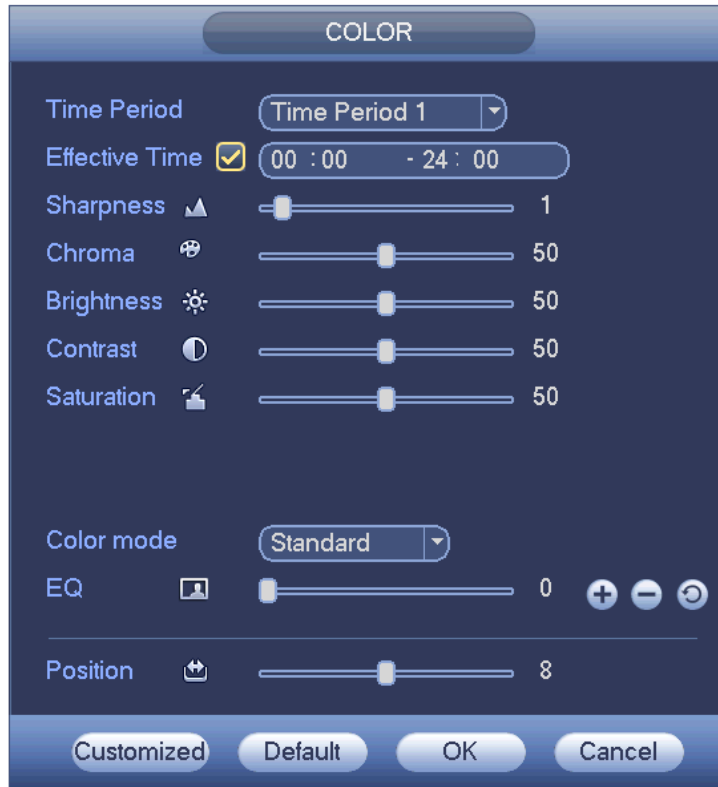





Figure 4-36

Please refer to the following sheet for detailed information.

Item	Note
Period	There are two periods in one day. You can set different sharpness, brightness, and contrast setup for different periods.
Effective Time	Check the box here to enable this function and then set period time.
Sharpness	The value here is to adjust the edge of the video. The value ranges from 0 to 100. The larger the value is, the clear the edge is and vice versa. Please note there is noise if the value here is too high. The default value is 50 and the recommended value ranges from 40 to 60.
Brightness	It is to adjust monitor window bright. The value ranges from 0 to 100. The default value is 50. The larger the number, the bright the video is. When you input the value here, the bright section and the dark section of the video will be adjusted accordingly. You can use this function when the whole video is too dark or too bright. Please note the video may become hazy if the value is too high. The recommended value ranges from 40 to 60.
Contrast	It is to adjust monitor window contrast. The value ranges

Item	Note
	<p>from 0 to 100. The default value is 50.</p> <p>The larger the number, the higher the contrast is. You can use this function when the whole video bright is OK but the contrast is not proper. Please note the video may become hazy if the value is too low. If this value is too high, the dark section may lack brightness while the bright section may over exposure .The recommended value ranges from 40 to 60.</p>
Saturation	<p>It is to adjust monitor window saturation. The value ranges from 0 to 100. The default value is 50.</p> <p>The larger the number, the strong the color is. This value has no effect on the general brightness of the whole video. The video color may become too strong if the value is too high. For the grey part of the video, the distortion may occur if the white balance is not accurate. Please note the video may not be attractive if the value is too low. The recommended value ranges from 40 to 60.</p>
Gain	<p>The gain adjust is to set the gain value. The default value may vary due to different device models. The smaller the value, the low the noise. But the brightness is also too low in the dark environments. It can enhance the video brightness if the value is high. But the video noise may become too clear.</p>
Color mode	<p>It includes several modes such as standard, color, bright, gentle. Select a color mode, the sharpness, brightness, contrast and etc can automatically switch to corresponding setup.</p>
EQ	<p>Click  or  to adjust image equalization value.</p> <p>Click reset button , system can auto adjust the video to the best effect.</p> <p>This function is for HD analog channel only.</p>
Image position	<p>It is to adjust the image position on the screen. The value here refers to the pixel. The default pixel value is 16.</p> <p>This function is for analog channel only.</p>

4.3.6 Image

If you connected analog camera supports this function, you can set analog channel properties.

On the preview window, right click mouse and then select Image, you can go to the

following interface. See Figure 4-37.



Figure 4-37

Please refer to the following sheet for detailed information.

Item	Note
Video standard	Please select according to your actual situation. There are two options:PAL/NTSC.
Resolution	It is to set video resolution: 720P@25, 720P@30, 1080P@25, 1080P@30.
Brightness	It is to adjust monitor window bright. The default value is 7. The larger the number, the bright the video is. When you input the value here, the bright section and the dark section of the video will be adjusted accordingly. You can use this function when the whole video is too dark or too bright. Please note the video may become hazy if the value is too high. The recommended value ranges from 0 to 15.
Contrast	It is to adjust monitor window contrast. The default value is 7. The larger the number, the higher the contrast is. You can use this function when the whole video bright is OK but the contrast is not proper. Please note the video may become hazy if the value is too low. If this value is too high, the dark section may lack brightness while the bright section may over exposure .The recommended value ranges from 0 to 15.

Item	Note
Saturation	It is to adjust monitor window saturation. The default value is 7. The larger the number, the strong the color is. This value has no effect on the general brightness of the whole video. The video color may become too strong if the value is too high. For the grey part of the video, the distortion may occur if the white balance is not accurate. Please note the video may not be attractive if the value is too low. The recommended value ranges from 0 to 15.
Sharpness	The value here is to adjust the edge of the video. The value ranges from 0 to 100. The larger the value is, the clear the edge is and vice versa. Please note there is noise if the value here is too high.
Flip	It is to set flip or pan operation.
Day&night	It is to set the image mode: color/black and white/auto. It has no relationship with the configuration file setup. The default setup is auto. <ul style="list-style-type: none"> ● Color: Camera outputs color image. ● Auto: System auto select image mode(color/black and white) according to the camera features(the whole brightness or there is IR light or not.) ● Black and white: Camera outputs black and white image.
Defog	In the fog or haze environment, you can enable defog function to enhance video effect. <ul style="list-style-type: none"> ● Close: It is to close defog mode. ● Manual: Select different defog intensity manually. ● Auto: It is to auto adjust video to guarantee clear image.
Refresh	Click it to get latest setup.
Default	Click it to restore factory default setup.

Click Save to complete the setup.

4.3.7 Auto Focus

Note

- This function is for the motorized-lens network camera.
- For HDMI HD auto focus camera, you can go to the PTZ control interface to set, Please refer to Chapter 4.7.

On the preview interface, right click mouse and then select Auto focus, you can go to the following interface. See Figure 4-38.

It is to set auto focus and zoom function. Click auto focus function, camera can realize auto focus function.

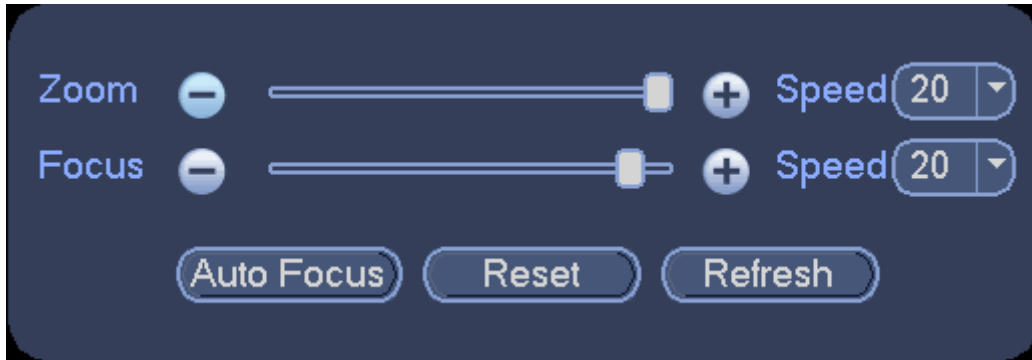

Figure 4-38

4.3.8 Preview and Display

It is to display preview video effect including image display mode, OSD and etc.

4.3.8.1 Display Output

On the preview interface, right click mouse and then select video output mode, there are two options: full screen (4:3) and original scale 16:9). Current output mode is checked by . See Figure 4-39.

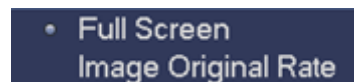

Figure 4-39

4.3.8.2 Display Effect

You can enable/disable time title, channel title display and set menu transparency. From main menu->Setting->System->Display->Display, display setup interface is shown as below. See Figure 4-40.

- Time display: You can select to display time or not when system is playback.
- Channel display: You can select to display channel name or not when system is playback.
- Original rate: Check the box here, the video can be displayed at its actual size.
- IVS rule preview: Check the box here, you can view IVS rule name on the preview window.
- POS info: Check the box here; you can view POS information on the preview window.
- Transparency: Here is for you to adjust menu transparency. The higher the value is, the more transparent the menu is.
- Screen enable: It is to set video output port.
- ◇ Screen 1: It refers to the screen connected to the VGA or the HDMI port. The video source is the same.
- ◇ Screen 2: It refers to the screen connected to the HDMI2 port. Check the box here to view the video from the network work camera; otherwise, it only displays the video from the analog camera.
- Screen No.: Select a screen from the dropdown list and then you can set resolution.

- Resolution: It is to set DVR resolution.
- ✧ System supports the following resolutions: 1920×1080, 1280×1024, 1280×720, 1024×768, 2560×1440, 3840×2160@25fps, 3840×2160@30fps.
- ✧ The default VGA/ HDMI1/HDMI2 resolution is 1280×1024.
- ✧ Please note the system needs to reboot to activate new setup.
- ✧ Right now, HDMI2 does not support 3840×2160@25fps, 3840×2160@30fps.
- Preview mode: Please select preview mode from the dropdown list. It includes two options:
 - ✧ General: There is no information on the preview window.
 - ✧ Human face: System displays human face information on the right pane of the preview window.

Please highlight icon  to select the corresponding function.
After you completed all the setups, please click Save button.



Figure 4-40

4.3.8.3 TV Adjust

Note

This function is for some series only.

From main menu->Setting->System->Display->TV Adjust, here is for you to adjust video output effect of the VIDEO OUT port. See Figure 4-41.

Please drag slide bar to adjust each item.

After you completed all the setups, please click Save button.



Figure 4-41

4.3.8.4 Zero-Channel Encoding

From main menu->Setting->System->Display->Zero channel, you can go to the following interface. See Figure 4-42. Here you can enable and set zero-channel encoding function so that you can view several video sources at one channel from WEB.

- Enable: This function is disabled by default. Check the box here to enable this function so that you can control the zero-channel encoding function at the WEB.
- Compression: System default setup is H.264. You can set according to device capability.
- Resolution: The resolution value may vary due to different device capabilities. Please select from the dropdown list.
- Frame rate: PAL: 1-25f/s. NTSC: 1-30f/s. The frame rate value may vary due to different device capabilities. Please select from the dropdown list.
- Bit Rate: The default setup is 1024Kb/S. The bit rate value may vary due to different device capabilities and frame rate setups. Please select from the dropdown list.
- Save: Click the Save button to save current setup. If this function is disabled, you can not operate zero-channel encoding function at the WEB, the video is black or null even you operate when the function is disabled. After you enabled this function, login the Web and you can select zero-channel encoding mode at the right corner of the



interface. Select a mode; you can view the local preview video.



Figure 4-42

4.3.9 Tour

Tour function allows you to view multiple-channel video at the specified interval on the preview window.

4.3.9.1 Tour Settings

Here you can activate tour function. Click Setup button, you can see an interface shown as in Figure 4-43.

- Enable tour: Highlight box here to enable this function.
- Screen No.: It is to select the screen you want to enable tour function.
- Interval: System supports 1/8-/window tour. Input proper interval value here. The value ranges from 5-120 seconds. It is for schedule tour/alarm/motion detect tour.
- Split: You can select window split mode from the dropdown list.
- Channel group: It is to display all channel groups on current split mode. You can edit and delete a channel group here. Double click an item in the list; you can edit its channel group setup. Right now system max supports 64.
- Add: Under specified window split mode, click it to add channel group.
- Delete: Click it to remove selected channel group.
- Move up: Click it to move current selected channel up.
- Move down: Click it to move current selected channel down.
- Default: Click it to restore default setup.

Tips:







- Use mouse or Shift button to switch  and  button to enable /disable tour. 
 means the tour function is enabled and  means tour function is disabled.
- On the navigation bar, click  or  to enable/disable tour function.



Figure 4-43

4.3.9.2 Video Matrix

Here you can set matrix video output, tour channel and its interval. You can set VIDEO OUT port tour and its interval See Figure 4-44.

- Enable tour: Check the box here to enable this function.
- Interval: Input proper interval value here.
- Resolution: The resolution of the tour window. Please note this function is for HDMI only.
- Split: You can select window split mode from the dropdown list. For BNC, it supports 1-split mode only. For HDMI, it supports 1/4/9/16-split mode. Some series product support 24/36-split. Please refer to the actual product.
- Add: Under specified window split mode, click it to add channel group. See Figure 4-45.
- Modify: Double click a channel or select a channel and then click Modify button, you can change current channel setup. See Figure 4-46.
- Delete: Click it to remove selected channel group.
- Move up: Click it to move current selected channel up.
- Move down: Click it to move current selected channel down.

- Default: Click it to restore default setup.



Figure 4-44



Figure 4-45



Figure 4-46

4.4 Search Human Face (Optional)

Note

This function is for some series product only.

On the preview window, right click mouse and then select face search, or from the main menu, click Face search, you can go to the following interface. See Figure 4-47.

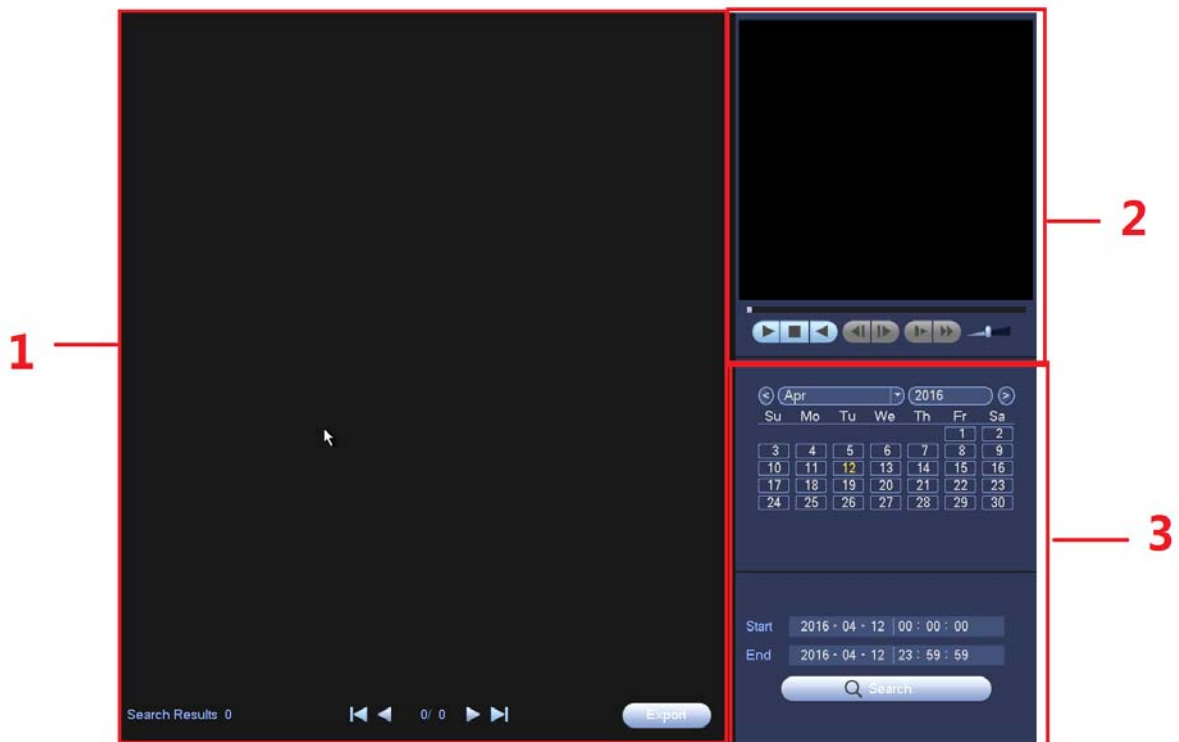



Figure 4-47

Please refer to the following sheet for detailed information.

SN	Name	Function
----	------	----------

SN	Name	Function
1	Display pan	<ul style="list-style-type: none"> It is to display human face detection file list. The latest file is at the bottom. Click Export, you can export the selected file to the USB device. There are two types: image/record. <ul style="list-style-type: none"> Image: Export the recognized human face image. Record: Export the record file before and after 10 seconds when the DVR recognizes the human face.
2	Playback pane	Play the searched record file or image. Double click the file or click button  to playback.
3	Search pane	Set date, start time and end time, click Search button, you can view the corresponding file list.

4.5 Fisheye

4.5.1 Fisheye De-Warp During Preview Interface

On the preview interface, select fisheye channel and then right click mouse, you can select fisheye. Now you can see an interface shown as in Figure 5-59. You can set fisheye installation mode and display mode.

Note:















- For the non-fisheye channel, system pops up dialogue box to remind you it is not a fisheye channel and does not support de-warp function.
- If system resources are insufficient, system pops up the corresponding dialogue box too.



Figure 4-48

There are three installation modes: ceiling mount/wall mount/ground mount. The different installations modes have different de-warp modes.

Please refer to the following sheet for detailed information.

Installation modes	Icon	Note
 (Ceiling mount)  (Ground mount)		360°panorama original view
		1 de-warp window+1 panorama stretching
		2 panorama stretching view
		1 360° panorama view+3 de-warp windows
		1 360°panorama view+4 de-warp windows
		4 de-warp windows+1 panorama stretching
		1 360° panorama view+8 de-warp windows
 (Wall mount)		360°panorama original view
		Panorama stretching
		1 panorama unfolding view+3 de-warp windows
		1 panorama unfolding view +4 de warp windows
		1 panorama unfolding view +8 de warp windows

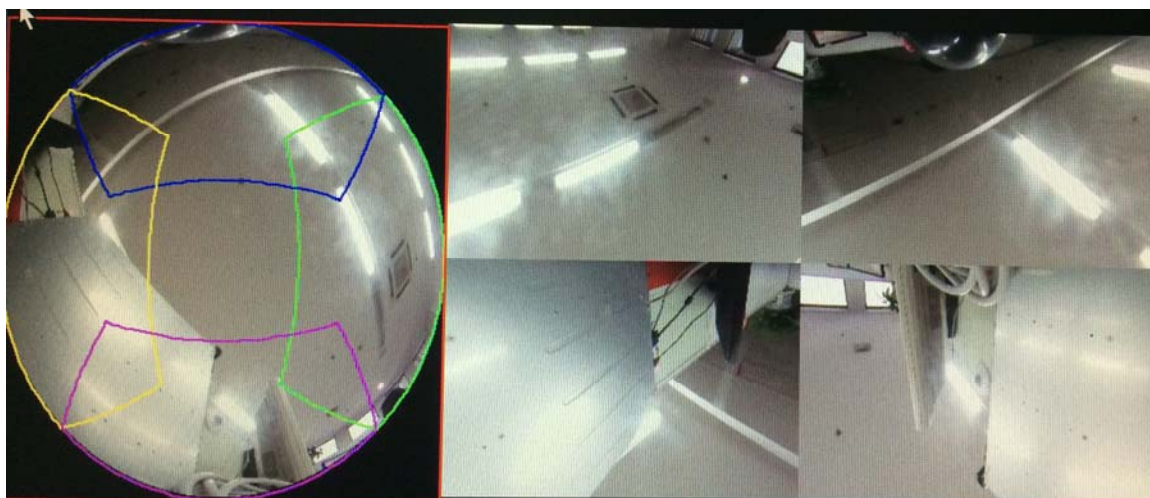



Figure 4-49

In Figure 4-49, you can adjust the color pane on the left pane or use your mouse to change the position of the small images on the right pane to realize fisheye de-warp. Please use the mouse to zoom in/zoom out, move/rotate the image. (Please note this function is not for wall mount mode)

4.5.2 Fisheye De-Warp During Playback

On the main menu, click search button.

Select 1-window playback mode and corresponding fisheye channel, click  to play.

Right click the , you can go to the de-warp playback interface. For detailed information, please refer to chapter 4.5.1.

4.6 Smart Track

This function allows you to view the trigger video of the fisheye&PTZ camera. The fisheye is the main camera to view the whole surveillance condition, the PTZ camera works as the slave camera to view the details.

On the preview interface, select the corresponding window, right click mouse and then select Smart track, you can see an interface shown as below. See Figure 4-50.

Note

Please refer to chapter 4.15.7 for setup information.



Figure 4-50

4.7 PTZ Control

Note:

Before you control the PTZ, please make sure the PTZ decoder and the DVR network connection is OK and the corresponding settings are right.

4.7.1 PTZ Settings

Please follow the procedures below to go on cable connection

- Connect the dome RS485 port to DVR RS485 port.
- Connect dome video output cable to DVR video input port.
- Connect power adapter to the dome.

In the main menu, from Setting->System->PTZ, the PTZ setup includes the following items. Please select channel first. See Figure 4-51.

- PTZ type: There are two options: local/remote. Please select remote if you are connecting to the network PTZ.
- Control mode: You can select control mode from the dropdown list. There are two options: Serial/HD AVS. For HD AVS series product, please select HD AVS. The control signal is sent to the PTZ via the coaxial cable. For the serial mode, the control signal is sent to the PTZ via the RS485 port.
- Protocol: Please select ICR-SD1 if the control mode is HD AVS.
- Address: input corresponding PTZ address.
- Baud rate: Select baud rate.
- Data bit: Select data bit.
- Stop bit: Select stop bit.
- Parity: There are three choices: none/odd/even.

After completed all the setups please click save button.



Figure 4-51

For digital channel, the interface is shown as below. See Figure 4-52.

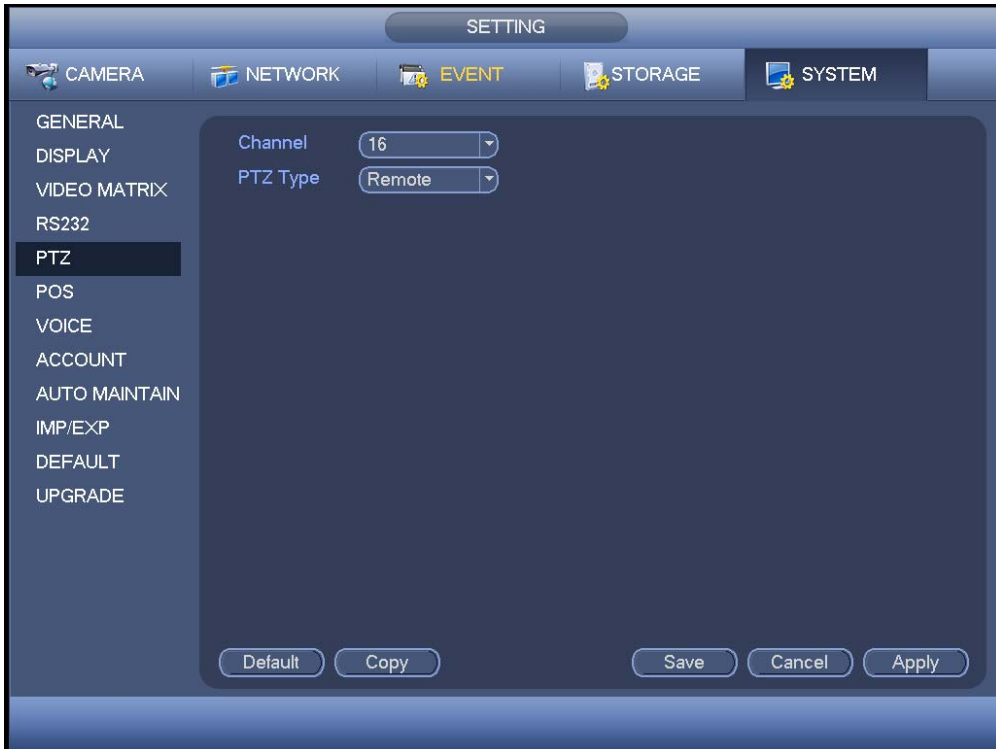

Figure 4-52

4.7.2 PTZ Operation



The PTZ setup is shown as in See Figure 4-53.

Please note the commend name is grey once device does not support this function.

The PTZ operation is only valid in one-window mode.

Here you can control PTZ direction, speed, zoom, focus, iris, preset, tour, scan, pattern aux function, light and wiper, rotation and etc.

Speed is to control PTZ movement speed. The value ranges from 1 to 8.The speed 8 is faster than speed 1. You can use the remote control to click the small keyboard to set.

You can click  and  of the zoom, focus and iris to zoom in/out, definition and brightness.

The PTZ rotation supports 8 directions. If you are using direction buttons on the front panel, there are only four directions: up/down/left/right.

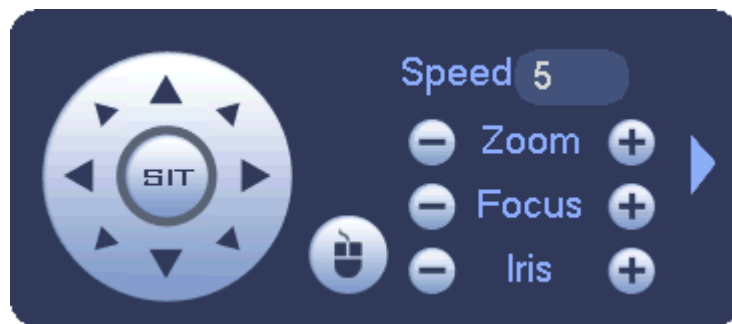

Figure 4-53

In the middle of the eight direction arrows, there is a 3D intelligent positioning key. See

Figure 4-54. Please make sure your protocol supports this function and you need to use mouse to control.

Click this key, system goes back to the single screen mode. Drag the mouse in the screen to adjust section size. The dragged zone supports 4X to 16X speeds. It can realize PTZ automatically. The smaller zone you dragged, the higher the speed.



Figure 4-54

Name	Function key	function	Shortcut key	Function key	function	Shortcut key
Zoom		Near			Far	
Focus		Near			Far	
Iris		close			Open	

In Figure 4-53, click to open the menu, you can set preset, tour, pattern, scan and etc. See Figure 4-55.

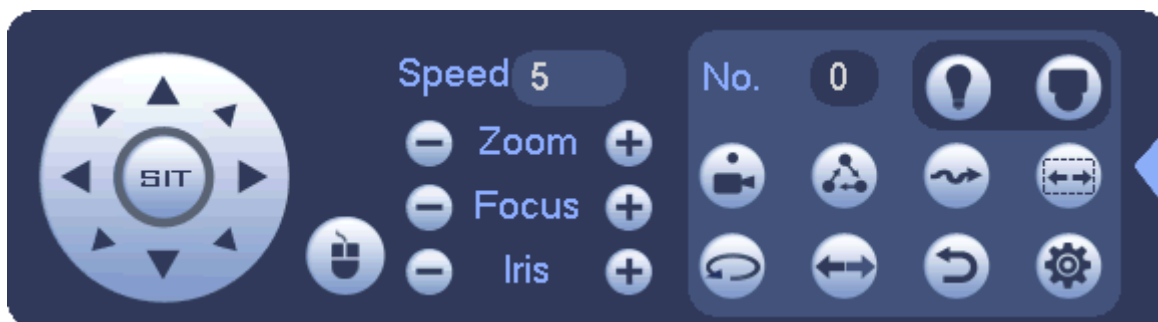

Figure 4-55

Please refer to the following sheet for detailed information.

Please note the above interface may vary due to different protocols. The button is grey and can not be selected once the current function is null.

Right click mouse or click the ESC button at the front panel to go back to the Figure 4-53.

Icon	Function	Icon	Function
	Preset		Flip
	Tour		Reset
	Pattern		Aux

	Scan		Aux on-off button
	Rotate		Go to menu

4.7.3 Coaxial Control

Important

- Coaxial control function is for some series cameras only
- Please refer to the user's manual for detailed information.

In Figure 4-55, there are two ways for you to call the menu and set.

- Mode 1: For general HD AVS camera only, Not for PTZ camera.

Click “Iris +” to call the OSD menu of the HD AVS camera. See Figure 4-56. Use direction buttons to select the parameters and click the “Iris +” to confirm.

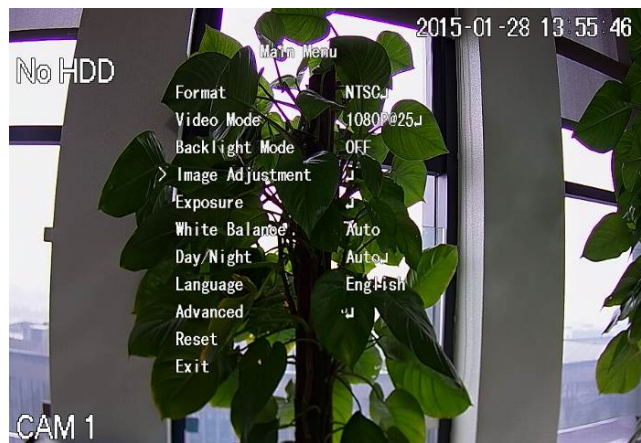

Figure 4-56

- Mode 2: For all HD AVS cameras.



Click , you can view menu operation interface. See Figure 4-57. Click the Enter button; you can see the OSD menu of the HD AVS camera. See Figure 4-56. Use direction buttons to select the parameters and click the “OK” to confirm.



Figure 4-57

Important

Coaxial cable control is not for all cameras. Please check before the operation.

4.7.4 Set PTZ Functions

In Figure 4-53, click  to open the menu, you can set preset, tour, pattern, scan and etc. See Figure 4-58.

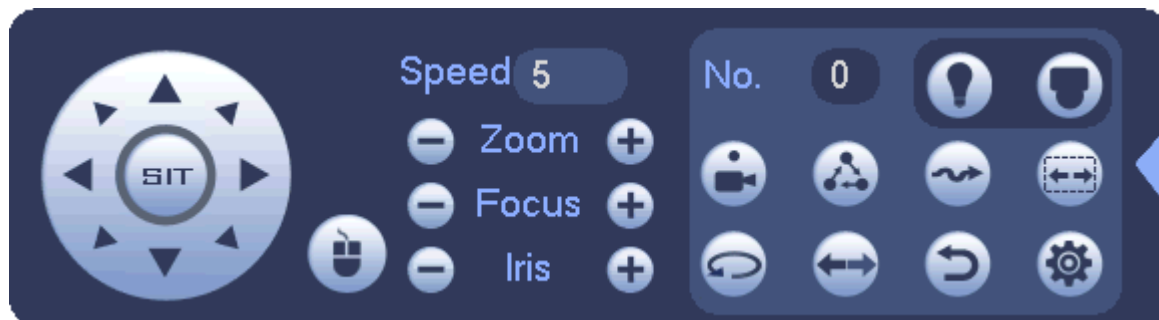











Figure 4-58

Please refer to the following sheet for detailed information.

Please note the above interface may vary due to different protocols. The button is grey and can not be selected once the current function is null.

Right click mouse or click the ESC button at the front panel to go back to the Figure 4-53.

Icon	Function	Icon	Function
	Preset		Flip
	Tour		Reset
	Pattern		Aux
	Scan		Aux on-off button
	Rotate		Go to menu

4.7.4.1 PTZ Function Setup

Click , you can go to the following interface to set preset, tour, pattern, and scan. See Figure 4-59.



Figure 4-59

Preset Setup

In Figure 4-59, click preset button and use eight direction arrows to adjust camera to the proper position. The interface is shown as in Figure 4-60.

Click Set button and then input preset number.

Click Set button to save current preset.



Figure 4-60

Tour Setup

In Figure 4-59, click tour button.

Input tour value and preset No. Click Add preset button to add current preset to the tour. See Figure 4-61.

Tips

Repeat the above steps to add more presets to the tour. Click Del preset button to remove it from the tour. Please note some protocols do not support delete preset function.



Figure 4-61

Pattern Setup

In Figure 4-59, click Pattern button and input pattern number. See Figure 4-62.

Click Begin button to start direction operation. Or you can go back to Figure 4-53 to operate zoom/focus/iris/direction operation.

In Figure 4-62, click End button.



Figure 4-62

Scan Setup

In Figure 4-59, click Scan button. See Figure 4-63.

Use direction buttons to set camera left limit and then click Left button.



Use direction buttons to set camera right limit and then click Right button. Now the scan setup process is complete.





Figure 4-63

4.7.5 Call PTZ Functions

Call Preset

In Figure 4-55, input preset value and then click  to call a preset. Click  again to stop call.



Call Pattern

In Figure 4-55, input pattern value and then click  to call a pattern. Click  again to stop call.

Call Tour

In Figure 4-55, input tour value and then click  to call a tour. Click again  to stop call.

Call Scan

In Figure 4-55, input Scan value and then click  to call a tour. Click again  to stop call.

Rotate

In Figure 4-55, click  to enable the camera to rotate. System supports preset, tour, pattern, scan, rotate, light and etc function.

Note:

- Preset, tour and pattern all need the value to be the control parameters. You can define it as you require.
- You need to refer to your camera user's manual for Aux definition. In some cases, it can be used for special process.

Aux



Click , system goes to the following interface. The options here are defined by the protocol. The aux number is corresponding to the aux on-off button of the decoder. See Figure 4-64.

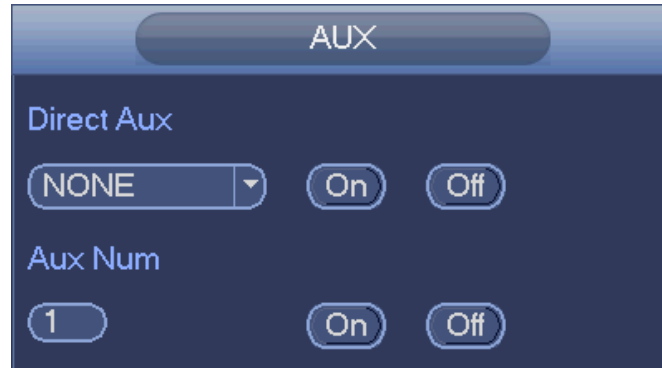

Figure 4-64

4.8 Navigation Bar

You need to go to the Main menu->Setting->System->General to enable navigation bar function; otherwise you can not see the following interface.

On the preview window, left click mouse, you can see the navigation bar is shown as below. See Figure 4-65.



Figure 4-65



4.8.1 Main Menu

Click button  to go to the main menu interface.

4.8.2 Output Screen



Select corresponding window-split mode and output channels.

4.8.3 Previous/Next Screen

Click  to go to the previous screen, click  to go to the next screen. For example, if you are using 4-split mode, the first screen is displaying the channel 1-4,

click , you can view channel 5-8.

4.8.4 Tour

Click button  to enable tour, the icon becomes , you can see the tour is in process.

4.8.5 Favorites

Click , system pops up add/edit favorites. See Figure 4-66.



Figure 4-66

In Figure 4-66, click Add to favorites; you can see the following interface. See Figure 4-67 . Here you can input customized favorites name. System max supports 31-character. Click OK button, you can save current favorites name.

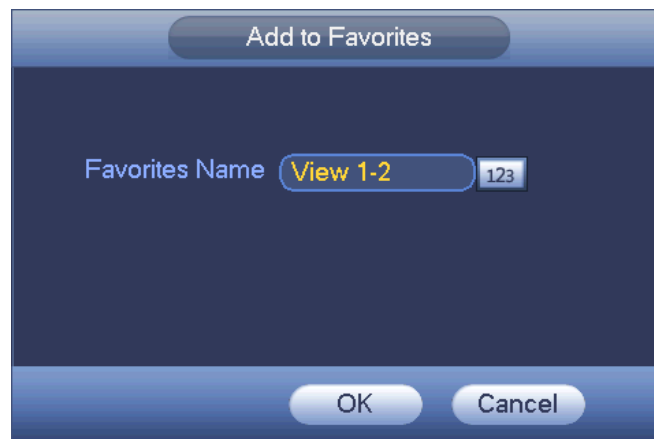

Figure 4-67

In Figure 4-66, click Edit favorites; you can see an interface shown as in Figure 4-68. Check the corresponding box and then select Delete, you can remove specified item(s).



Figure 4-68

Double click a name; you can change its name. See Figure 4-69. Input a new name and then click OK button.



Figure 4-69

4.8.6 Channel

It is to pop up channel tree. You can left click to select a channel on the tree and then drag it to the preview window on the left pane. See Figure 4-70.

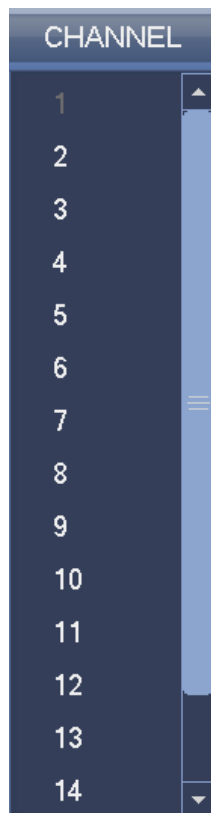



Figure 4-70

4.8.7 PTZ

Click , system goes to the PTZ control interface. Please refer to chapter 4.7.

4.8.8 Color

Click button , system goes to the color interface. Please refer to chapter 4.3.8.

4.8.9 Search

Click button , system goes to search interface. Please refer to chapter 4.10.

4.8.10 Alarm Status

Click button , system goes to alarm status interface. It is to view device status and channel status. Please refer to chapter 4.21.2.

4.8.11 Channel Info

Click button , system goes to the channel information setup interface. It is to view information of the corresponding channel. See Figure 4-71.



The screenshot shows a web interface titled "CHANNEL INFO" with a table listing 16 channels. Each channel has columns for Motion, Video Loss, Tampering, Record Status, Record Mode, Resolution, Frame Rate, and Bit Rate. The "Video Loss" column contains red alarm icons for channels 2 through 14, while channels 1, 15, and 16 have green status icons. A "Refresh" button is located at the bottom left of the interface.

Channel	Motion	Video Loss	Tampering	Record Status	Record Mode	Resolution	Frame Rate	Bit Rate
1	●	▲	●	■	Regular	1920*1080	30	
2	●	▲	●	■	Regular	1920*1080	30	
3	●	▲	●	■	Regular	1920*1080	30	
4	●	▲	●	■	Regular	1920*1080	30	
5	●	▲	●	■	Regular	1920*1080	30	
6	●	▲	●	■	Regular	1920*1080	30	
7	●	▲	●	■	Regular	1920*1080	30	
8	●	▲	●	■	Regular	1920*1080	30	
9	●	▲	●	■	Regular	1920*1080	30	
10	●	▲	●	■	Regular	1920*1080	30	
11	●	▲	●	■	Regular	1920*1080	30	
12	●	▲	●	■	Regular	1920*1080	30	
13	●	▲	●	■	Regular	1920*1080	30	
14	●	▲	●	■	Regular	1920*1080	30	
16	●	●	●	■	Regular	1920*1080	9	8

Figure 4-71

4.8.12 Registration

Click , system goes to an interface for you to view remote device information. Please refer to chapter 4.2.4.

4.8.13 Network

Click , system goes to the network interface. It is to set network IP address, default gateway and etc. Please refer to chapter 4.12.

4.8.14 HDD Manager

Click , system goes to the HDD manager interface. It is to view and manage HDD information. Please refer to chapter 4.16.1.

4.8.15 USB Manager

Click , system goes to the USB Manager interface. See Figure 4-72.

It is to view USB information, backup and update. Please refer to chapter 4.11.1 File backup, chapter 4.21.4 Log, chapter 4.19.2 Import/export, and chapter 4.19.4 System upgrade for detailed information.



Figure 4-72

4.9 Record and Snapshot

4.9.1 Snapshot

4.9.1.1 Schedule Snapshot

- On the preview interface, right click mouse and then select Manual->Record, or in the main menu, from Setting->Storage->Record, check the box to enable snapshot function of corresponding channels. See Figure 4-73.

- In main menu, from Setting->Camera->Encode->Snapshot interface, here you can input snapshot mode as regular, size, quality and frequency. See Figure 4-74.
- In main menu, from Setting-> Schedule->Snapshot interface, please enable snapshot function. See Figure 4-75.

Please refer to the following figure for detailed information.

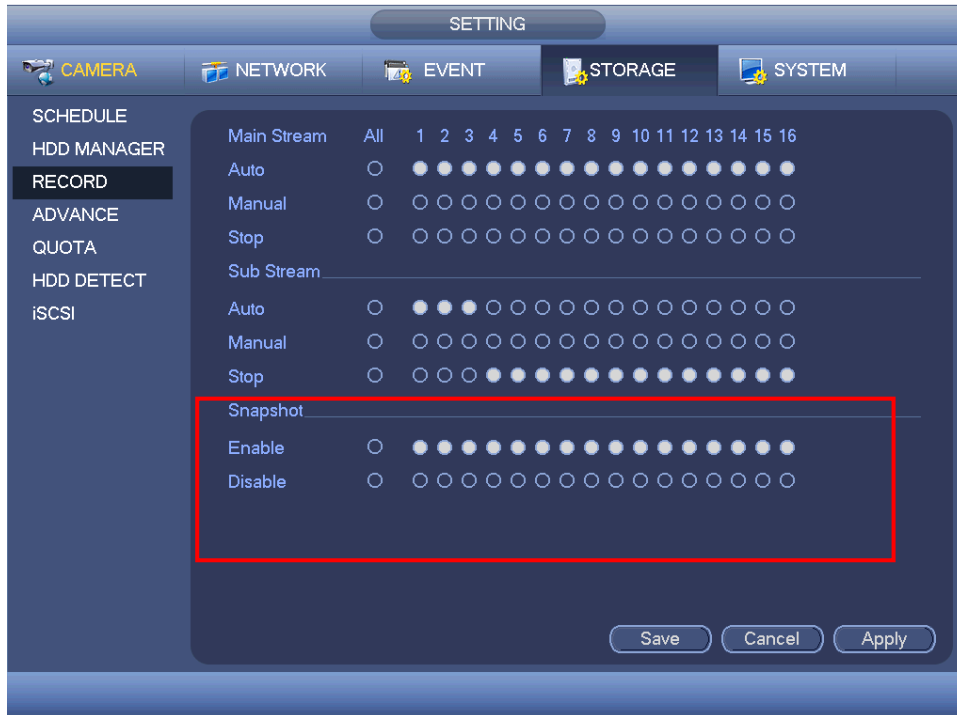

Figure 4-73

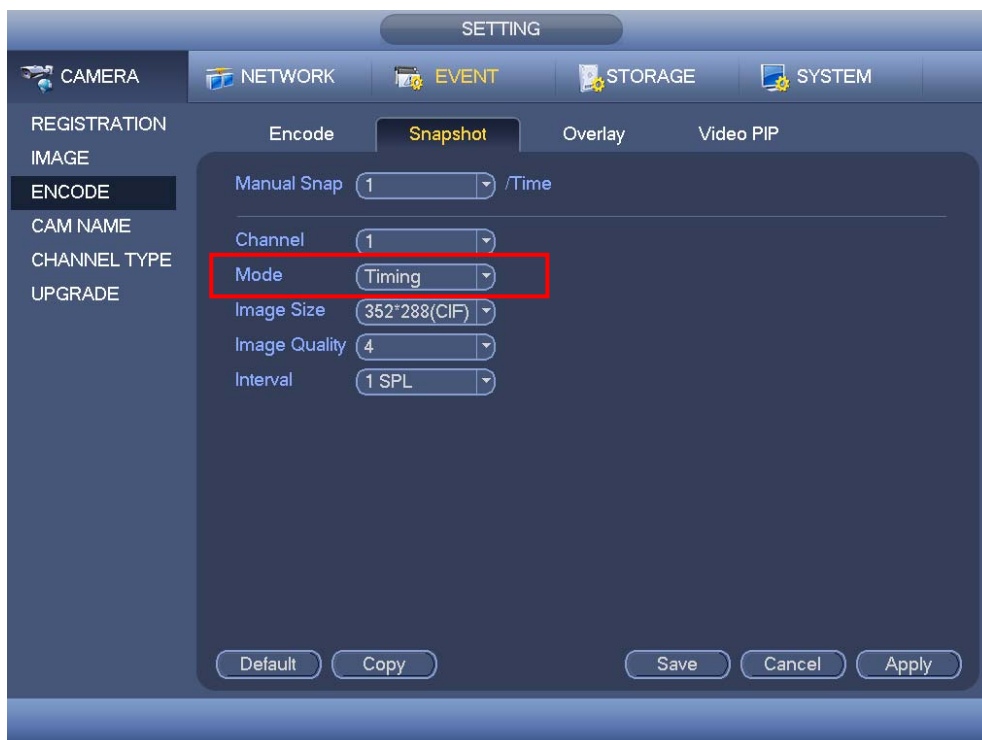

Figure 4-74

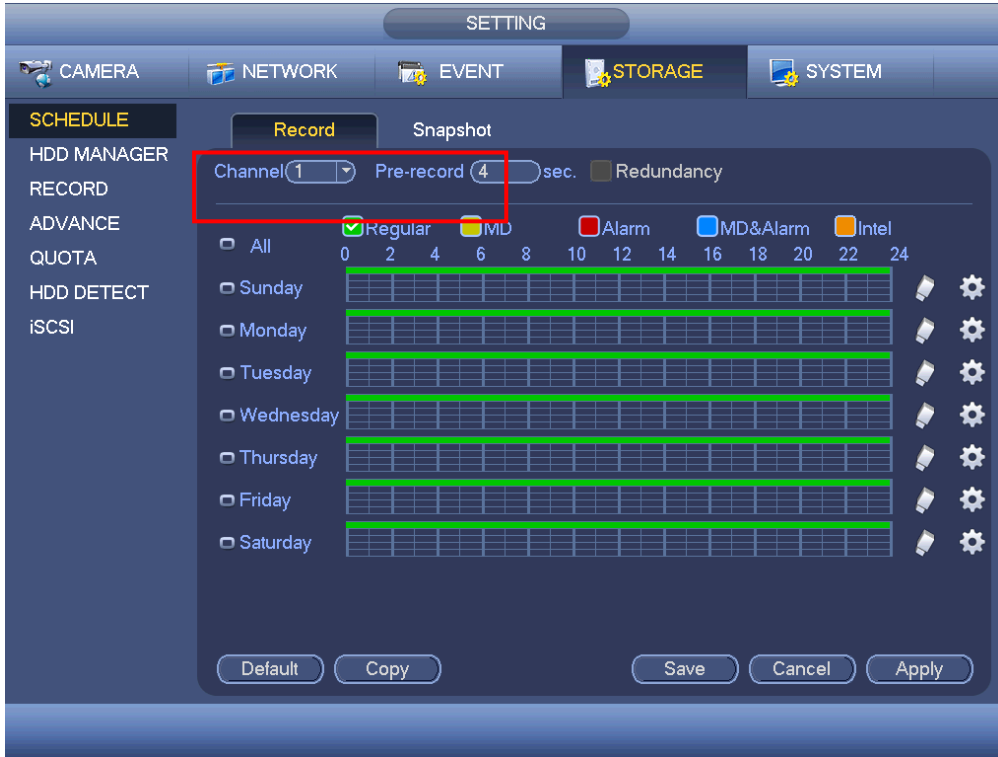

Figure 4-75

4.9.1.2 Trigger Snapshot

Please follow the steps listed below to enable the activation snapshot function. After you enabled this function, system can snapshot when the corresponding alarm occurs.

- In main menu, from Setting->Camera->Encode->Snapshot interface, here you can input snapshot mode as trigger, size, quality and frequency. See Figure 4-76.
- In main menu, from Setting->Video detect->Motion detect, please enable snapshot function for specified channels (Figure 4-77). Or In main menu, from Setting->Event->Alarm (Figure 4-78) please enable snapshot function for specified channels.

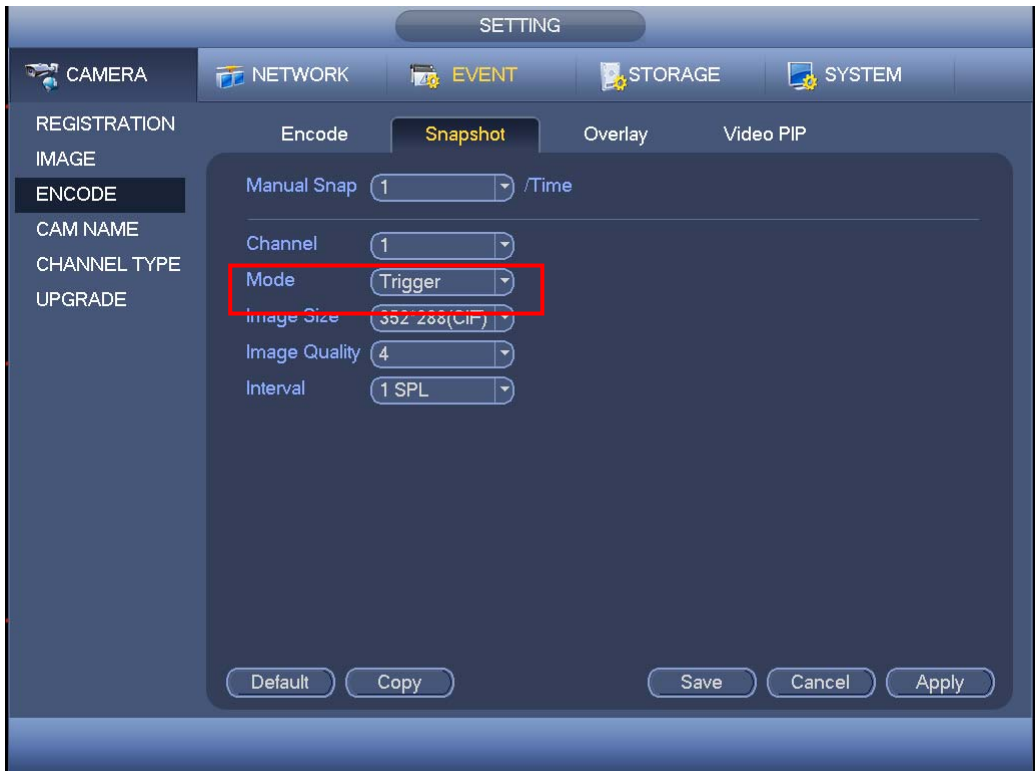

Figure 4-76

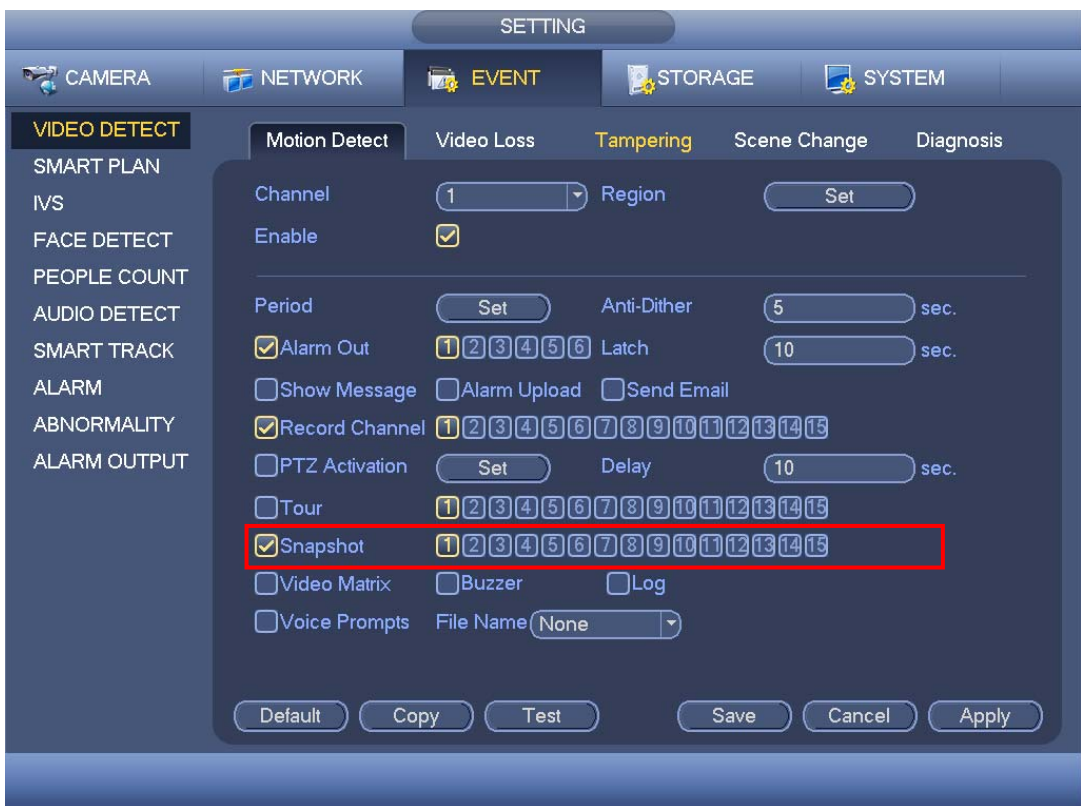

Figure 4-77

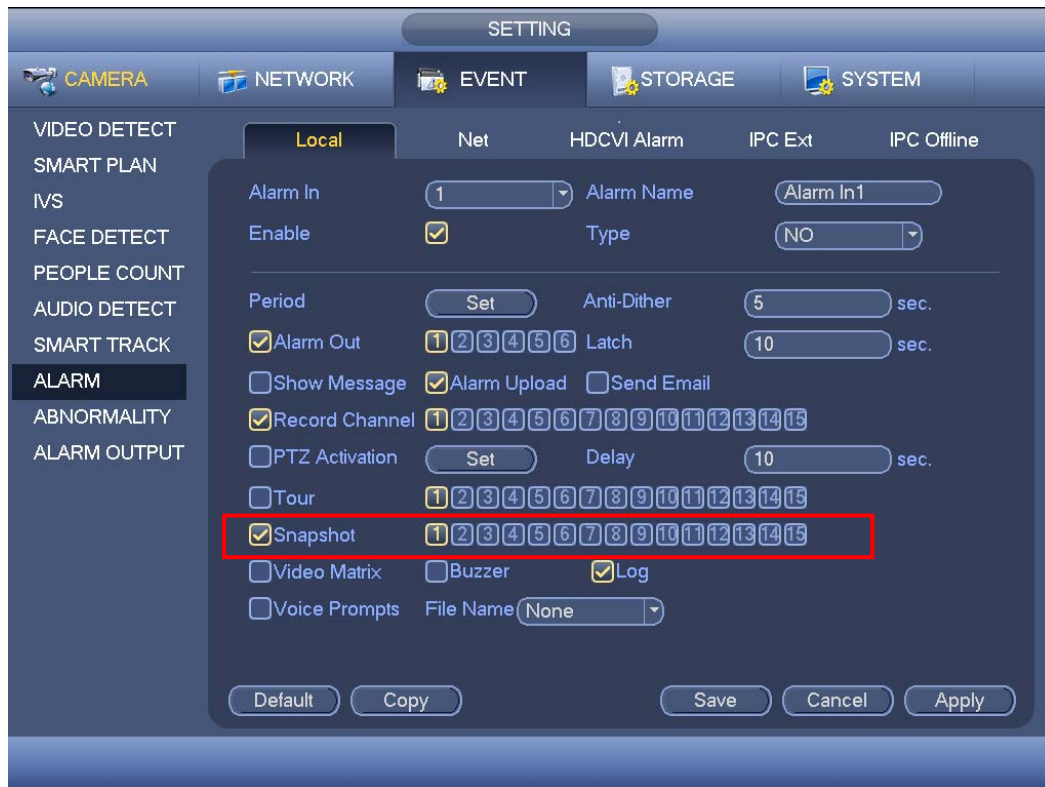

Figure 4-78

4.9.1.3 Priority

Please note the activation snapshot has the higher priority than schedule snapshot. If you have enabled these two types at the same time, system can activate the activation snapshot when an alarm occurs, and otherwise system just operates the schedule snapshot.

4.9.1.4 Image FTP

In the main menu, from Setting->Network->FTP, you can set FTP server information. Please enable FTP function and then click save button. See Figure 4-79.

Please boot up corresponding FTP server.

Please enable schedule snapshot (Chapter 4.9.1.1) or activation snapshot (Chapter 4.9.1.2) first, now system can upload the image file to the FTP server.



Figure 4-79

4.9.2 Record

The record priority is: Alarm>Motion detect>Regular.

4.9.2.1 Schedule Record

System can record regularly as you specified.

- On the preview interface, right click mouse and then select Manual->Record, or in the main menu, from Setting->Storage->Record, check the box to enable schedule function of corresponding channels. See Figure 4-80.

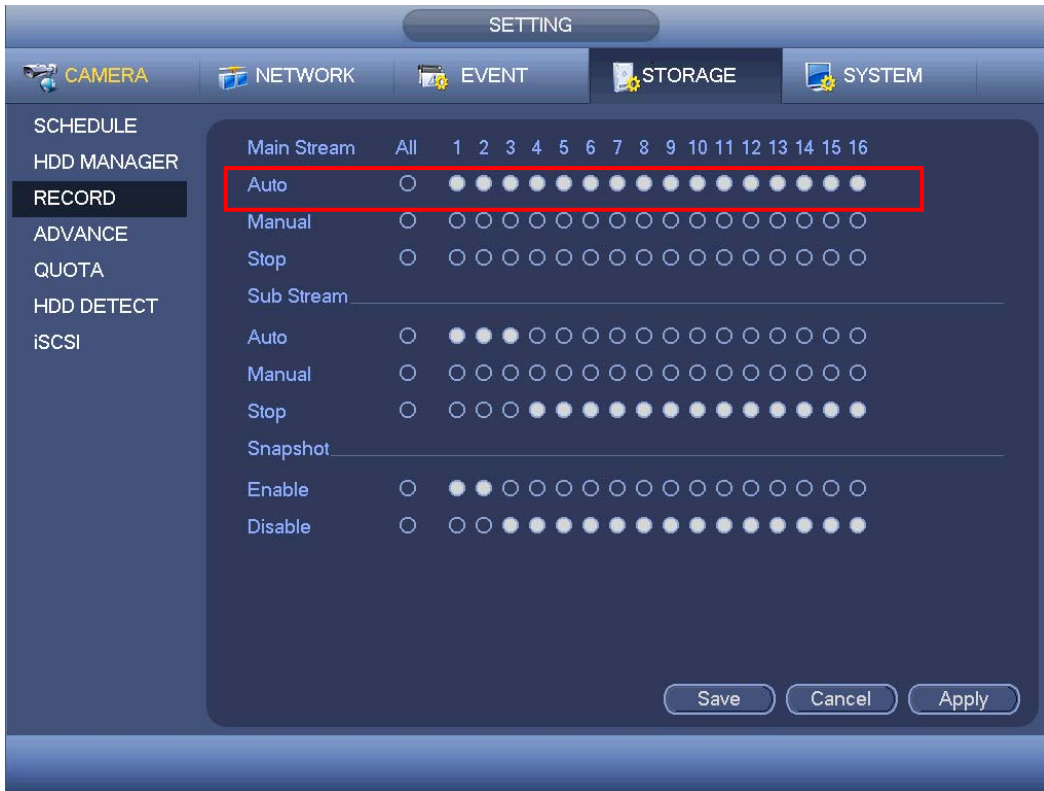

Figure 4-80

In main menu, from Setting-> Schedule->Record interface, please enable record function and then select regular mode and set corresponding period. See Figure 4-81.

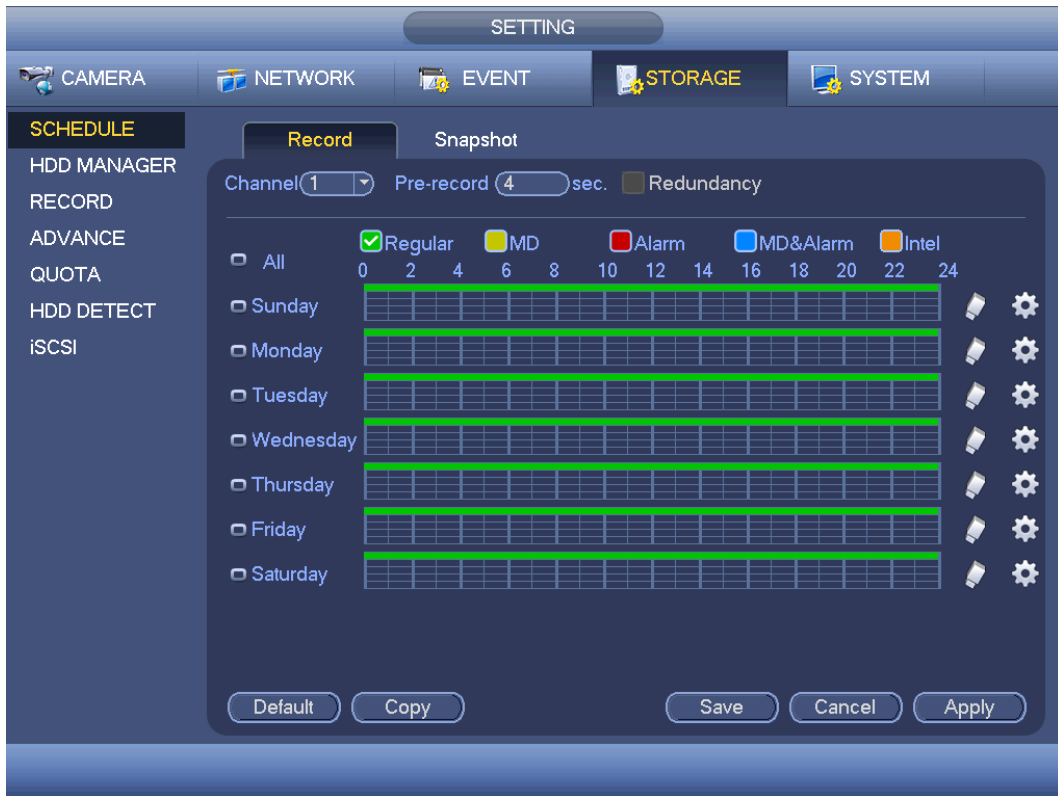

Figure 4-81

4.9.2.2 Event/Alarm Record

System can record video once corresponding event occurs.

4.9.2.2.1 Event record

For event record function, here we use motion detection alarm to follow.

From Main menu->Setting->Video detect->Motion detect, you can set motion detect alarm record function. See Figure 4-82.

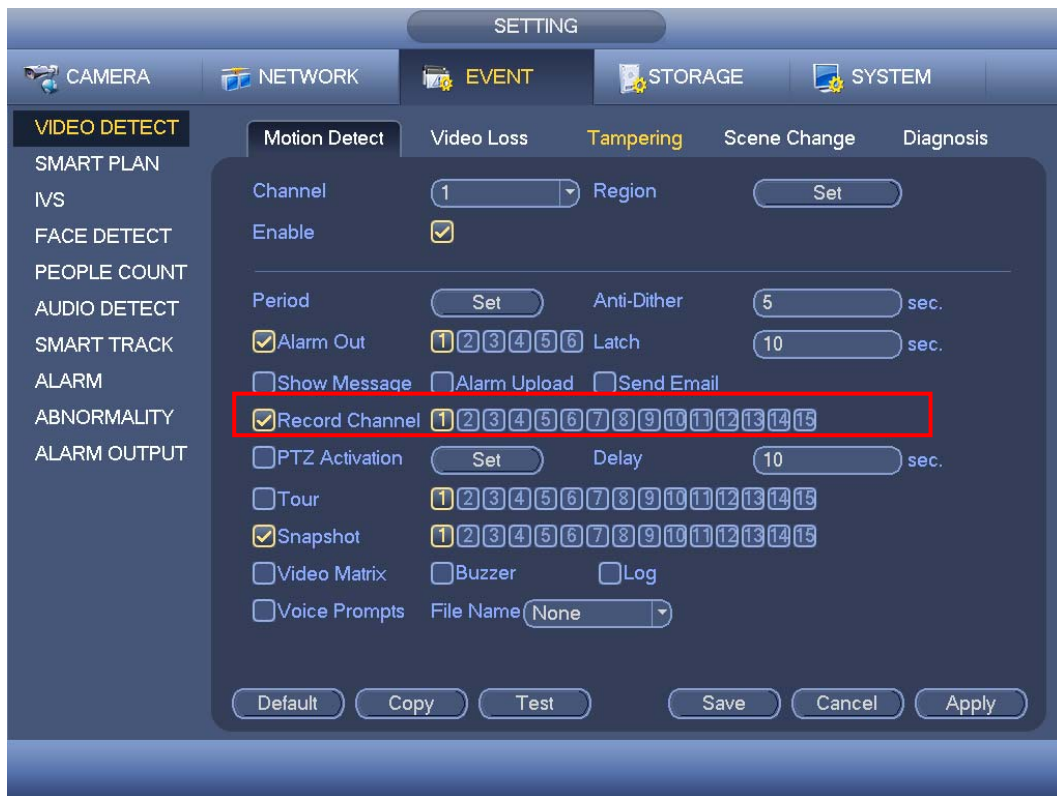

Figure 4-82

4.9.2.2.2 Alarm record

From Main menu->Setting->Alarm->Local, you can set local alarm record function. See Figure 4-83.

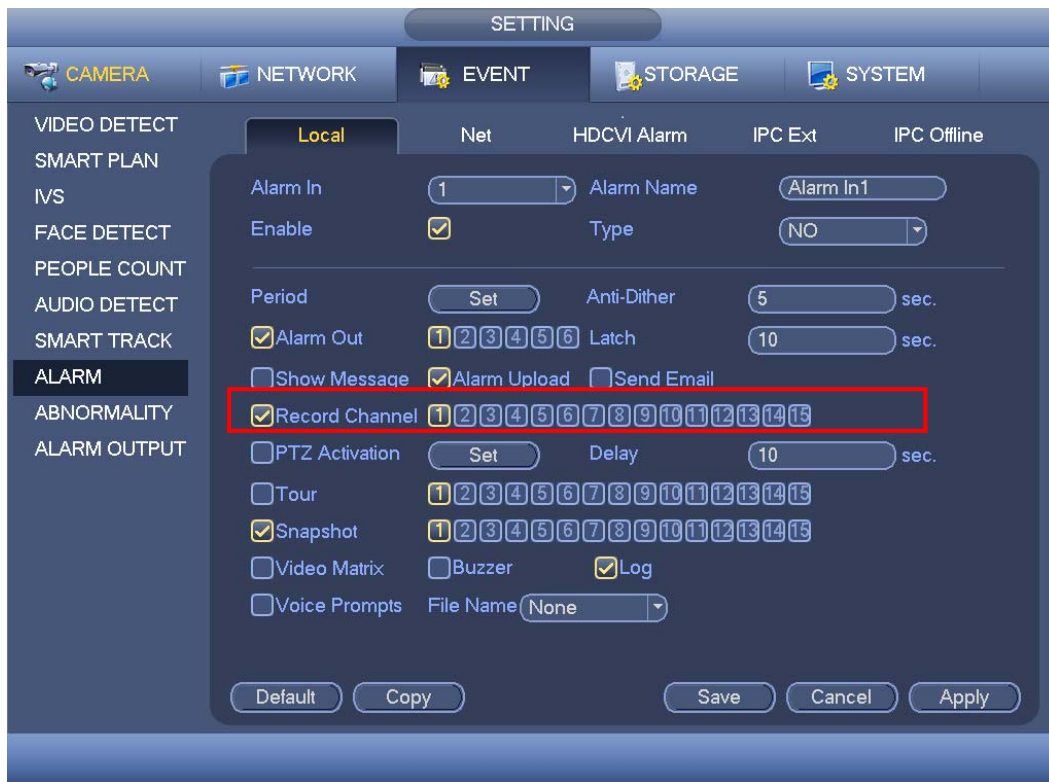

Figure 4-83

4.10 Search and Playback

Here you can search and play corresponding file or image.

4.10.1 Instant Playback

Please refer to chapter 4.3.2.1 for instant playback information.

4.10.2 Search

Click search button in the main menu, search interface is shown as below. See Figure 4-84.

Usually there are four file types:

- R: Regular recording file.
- A: External alarm recording file.
- M: Motion detection recording file
- Orange: Intelligent recording file.

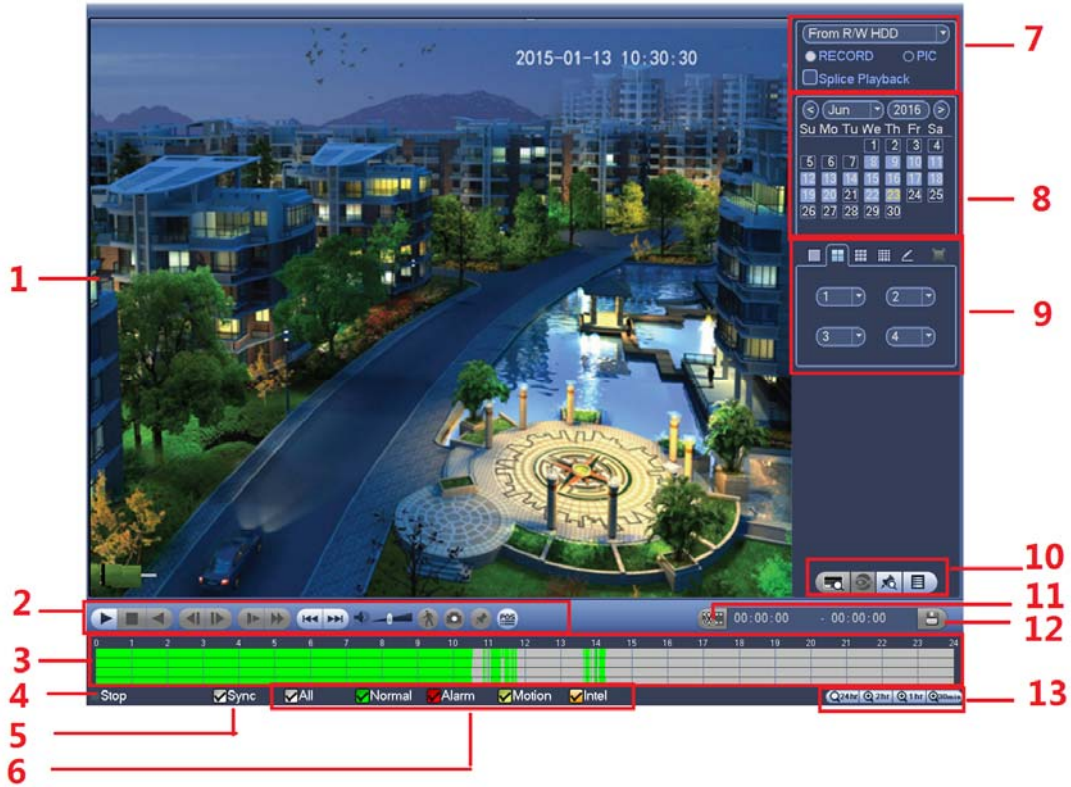









Figure 4-84

Please refer to the following sheet for more information.

SN	Name	Function
1	Display window	Here is to display the searched picture or file. Support 1/4/9/16-window playback. (It depends on the product channel amount).
2	Playback control pane	Please refer to chapter 4.10.2.1 for detailed information.
3	Time bar	<ul style="list-style-type: none"> ● It is to display the record type and its period in current search criteria. ● In 4-window playback mode, there are corresponding four time bars. In other playback mode, there is only one time bar. ● Use the mouse to click one point of the color zone in the time bar, system begins playback. ● The time bar is beginning with 0 o'clock when you are setting the configuration. The time bar zooms in the period of the current playback time when you are playing the file. ● The green color stands for the regular record file. The red color stands for the external alarm record file. The yellow stands for the motion detect record file. The orange stands for intelligent record file.
4	Plat status	It is to display current play status. It includes play/stop.

SN	Name	Function
5	Sync playback	Check the boxed here, you can playback the video of the same time from multiple-channel.
6	Recod type	Check the box(es) here to select searched record type(s). Note Intelligent record is for some series product.
7	Search type	<ul style="list-style-type: none"> ● Here you can select to search the picture or the recorded file. ● You can select to play from the read-write HDD, from peripheral device or from redundancy HDD. ● Before you select to play from the peripheral device, please connect the corresponding peripheral device. You can view all record files on the root directory of the peripheral device. Click the Browse button you can select the file you want to play. <p>Important Redundancy HDD does not support picture backup function, but it supports picture playback function. You can select to play from redundancy HDD if there are pictures on the redundancy HDD.</p>
8	Calendar	<ul style="list-style-type: none"> ● The blue highlighted date means there is picture or file. Otherwise, there is no picture or file. ● In any play mode, click the date you want to see, you can see the corresponding record file trace in the time bar.
9	Playback mode and channel selection pane.	<ul style="list-style-type: none"> ● Playback mode: 1/4/9/16. (It may vary due to different series.) In 1-window playback mode: you can select 1-X channels (X depends on the product channel amount). In 4-window playback mode: you can select 4 channels according to your requirement. In 9-window playback mode, you can switch between 1-8, 9-16 and etc channels. In 16-window playback mode, you can switch between 1-16, 17-32 and etc channels. ● The time bar will change once you modify the playback mode or the channel option.
10	List Pane	 POS record list Click it, you can search POS record. System supports fuzzy search and accurate search. You can view the results on the right pane. Double click the file name to playback.
		 Mark button. Click it to display all files of mark icon. Double click a file to play. You can refer to chapter 4.10.4 for detailed information.
		 File list Click it to view searched file. Here you can lock or unlock file. You can refer to chapter 4.10.8 for detailed information.

SN	Name	Function
		 Fisheye de-warp playabck. You can refer to chapter 4.5 for detailed information.
11	Clip	It is to edit the file and save. You can refer to chapter 4.10.2.2 for detailed information.
12	Backup	It is to backupf files. You can refer to chapter 4.10.2.3 for detailed information.
13	Time bar unit	<ul style="list-style-type: none"> The option includes: 、、和，. The smaller the unit, the larger the zoom rate. You can accurately set the time in the time bar to playback the record. <p>The time bar is beginning with 0 o'clock when you are setting the configuration. The time bar zooms in the period of the current playback time when you are playing the file.</p>











4.10.2.1 Playback Control







The playback control interface is shown as below. See Figure 4-85.



Figure 4-85

Please refer to the following sheet for more information.

Icon	Function
	Play/Pause In slow play mode, click it to switch between play/pause.
	Backward play <ul style="list-style-type: none"> In normal play mode, left click the button, the file begins backward play. Click it again to pause current play. In backward play mode, click  or  to restore normal play.
	Display previous frame/next frame. <ul style="list-style-type: none"> When pause the normal playback file, click  or  to playback frame by frame. In frame by frame playback mode, click  or  to resume normal playback mode.
	Slow play In playback mode, click it to realize various slow play modes such as slow play 1, slow play 2, and etc.
	Fast forward In playback mode, click to realize various fast play modes such as fast play 1,fast play 2 and etc.

Icon	Function
	Adjust the volume of the playback
	Smart search . You can refer to chapter 4.10.3 for detailed information.
	Click the snapshot button in the full-screen mode, the system can snapshot 1 picture. System supports custom snap picture saved path. Please connect the peripheral device first, click snap button on the full-screen mode, you can select or create path. Click Start button, the snapshot picture can be saved to the specified path.
	Mark button. Please note this function is for some series product only. Please make sure there is a mark button in the playback control pane. You can refer to chapter 4.10.4 for detailed information.
	Display/hide POS information. In 1-channel playback mode, you can click it to display/hide POS information on the video.
	Note This function is for some series only. In 1-channel playback mode, click it to enable/disable display IVS rule information on the video.

4.10.2.2 Clip

This function allows you to clip some footages to a new file and then save to the USB device. See Figure 4-86. Please follow the steps listed below.





- 1) Select a record first and then click  to playback.
- 2) Select a time at the time bar and then click  to start clip,
- 3) Select a time at the time bar and then click  to stop clip,
- 4) Click , system pops up dialogue box to save the clip file.



Figure 4-86

Note

- Clip function is for one-channel/multiple-channel.
- Max save 1024 files at the same time.
- This function is not for the file already checked in the file list.

4.10.2.3 Backup

This function is to backup files you checked in the file list, or the file you just clip.

On the main menu, click backup button, you can see an interface is shown as in Figure 4-87. Here is for you to view devices information.

You can view backup device name and its total space and free space. The device includes CD-RW, DVD burner, USB device, flash disk, eSATA backup.

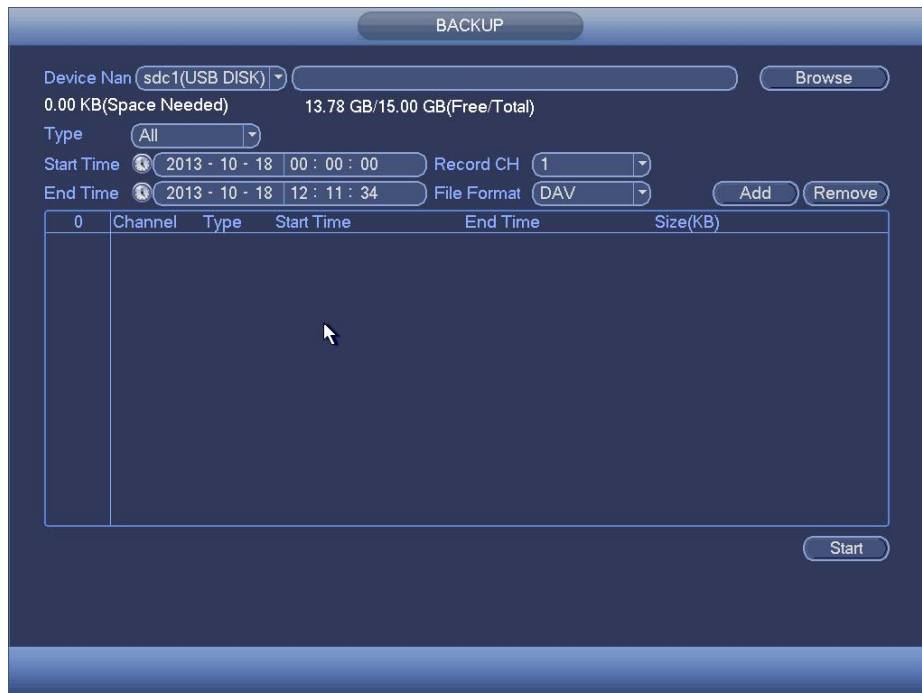

Figure 4-87

Select backup device and then set channel, file start time and end time.

Click add button, system begins search. All matched files are listed below. System automatically calculates the capacity needed and remained. See Figure 4-88.



Figure 4-88

System only backup files with a before channel name. You can use Fn or cancel button to delete after file serial number.

Click Start button, system begins copy. At the same time, the backup button becomes stop button. You can view the remaining time and process bar at the left bottom. See Figure 4-89.

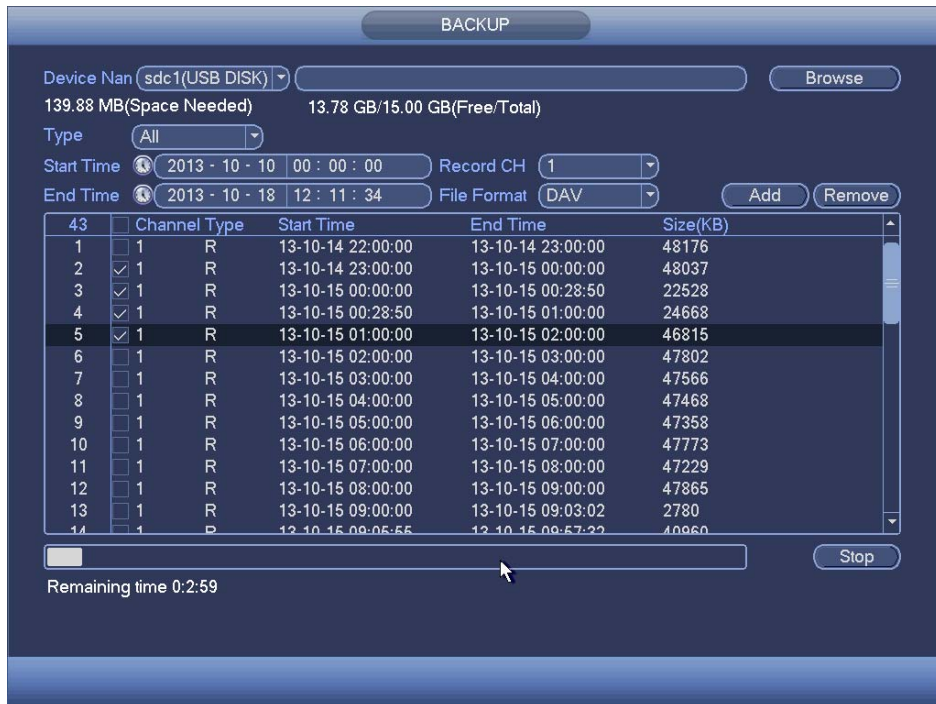

Figure 4-89

When the system completes backup, you can see a dialogue box prompting successful backup.

- File format: Click the file format; you can see there are two options: DAV/ASF. The file name format usually is: Channel number+Record type+Time. In the file name, the YDM format is Y+M+D+H+M+S. File extension name is .dav.

Tips:

During backup process, you can click ESC to exit current interface for other operation. The system will not terminate backup process.

Note:

When you click stop button during the burning process, the stop function becomes activated immediately. For example, if there are ten files, when you click stop system just backup five files, system only save the previous 5 files in the device (But you can view ten file names).

4.10.3 Smart Search Playback

Note

This function is for some series product only.



During playback process, it can analyze the motion detect zone in the scene and give the analysis result.

This function is for channel that already enabled motion detect function (main menu->Setting->Event->Video detect->Motion detect).

Please follow the steps listed below.

- 1) Select a channel to playback video and then click . You can view the grids on the playback video.

Note

- This function is for one-channel playback mode.
 - If you are in multiple-channel playback mode, double click a channel first to switch to one-channel playback mode.
- 2) Left click mouse and then drag to select smart search zones(22*18 (PAL), 22*15 (NTSC)).
 - 3) Click  to go to smart search and playback. System is going to playback all motion detect record footages.
 - 4) Click  again to stop smart search function.

4.10.4 Mark Playback

Please make sure your purchased device support this function. You can use this function only if you can see the mark playback icon on the Search interface (Figure 4-84).

When you are playback record, you can mark the record when there is important information. After playback, you can use time or the mark key words to search corresponding record and then play. It is very easy for you to get the important video information.

- Add Mark

When system is playback, click Mark button , you can go to the following interface. See Figure 4-90.

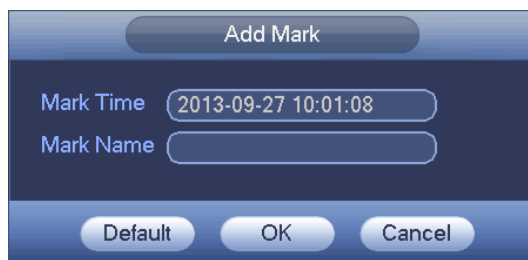



Figure 4-90

- Playback Mark

During 1-window playback mode, click mark file list button  in Figure 4-84, you can go to mark file list interface. Double click one mark file, you can begin playback from the mark time.

- Play before mark time

Here you can set to begin playback from previous N seconds of the mark time.

Note

Usually, system can playbacks previous N seconds record if there is such kind of record file. Otherwise, system playbacks from the previous X seconds when there is such as kind of record.

- Mark Manager

Click the mark manager button  on the Search interface (Figure 4-84); you can go to Mark Manager interface. See Figure 4-91. System can manage all the record mark information of current channel by default. You can view all mark information of current channel by time.

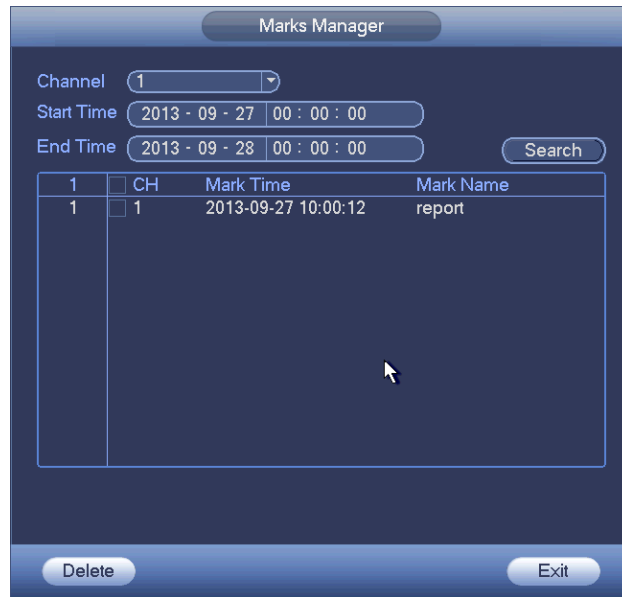

Figure 4-91

- **Modify**

Double click one mark information item, you can see system pops up a dialogue box for you to change mark information. You can only change mark name here.

- **Delete**

Here you can check the mark information item you want to delete and then click Delete button, you can remove one mark item. .

Note

- After you go to the mark management interface, system needs to pause current playback. System resume playback after you exit mark management interface.
- If the mark file you want to playback has been removed, system begins playback from the first file in the list.

4.10.5 Playback Image

Here you can search and play the image. Please follow the steps listed below.

- 1) From main menu->Search, or on the preview window right click mouse and then click Search, you can go to the search interface.
- 2) At the top right corner, select image and then input playback interval.
- 3) Select date and channel, click  to play.

4.10.6 Splice Playback

For the large record file, you can use splice playback function to play the same file in several sections at the same time. It is very convenient for you to find the video footages you desire.

On the main menu, click Search button, or right click mouse and then select Search. You can go to the Figure 4-84.

On the right pane, check the box to enable splice playback function, and then set channel,

date, split mode. The splice playback interface is shown as below. Each section has a small triangle; you can adjust it to set time. See Figure 4-92.



Figure 4-92

Note

Select split mode, so that the record can be spliced in several sections.

Select splice file.

- Click Playback, system playbacks from the first of current date by default.
- Click time bar, system playbacks from the time you click.
- Click , you can select on the file list.

Note

- The splice playback is for 1-window playback mode.
- System supports 1/4/8/16-split mode. Slight different may be found here. The 4-channel series product supports 4-split mode. The 8-channel series product support 8-split mode. The 16-channel or higher series product supports 16-split mode.
- The min period of each section is 5 minutes. For the record is less than 20 minutes, if you select 4-split mode (or more than 4-split mode), system can auto adjust so that the each section period is 5 minutes. In this situation, some channel may have no video.

4.10.7 File List

Click , system displays file list. It displays the first channel of the record. See Figure 4-93.

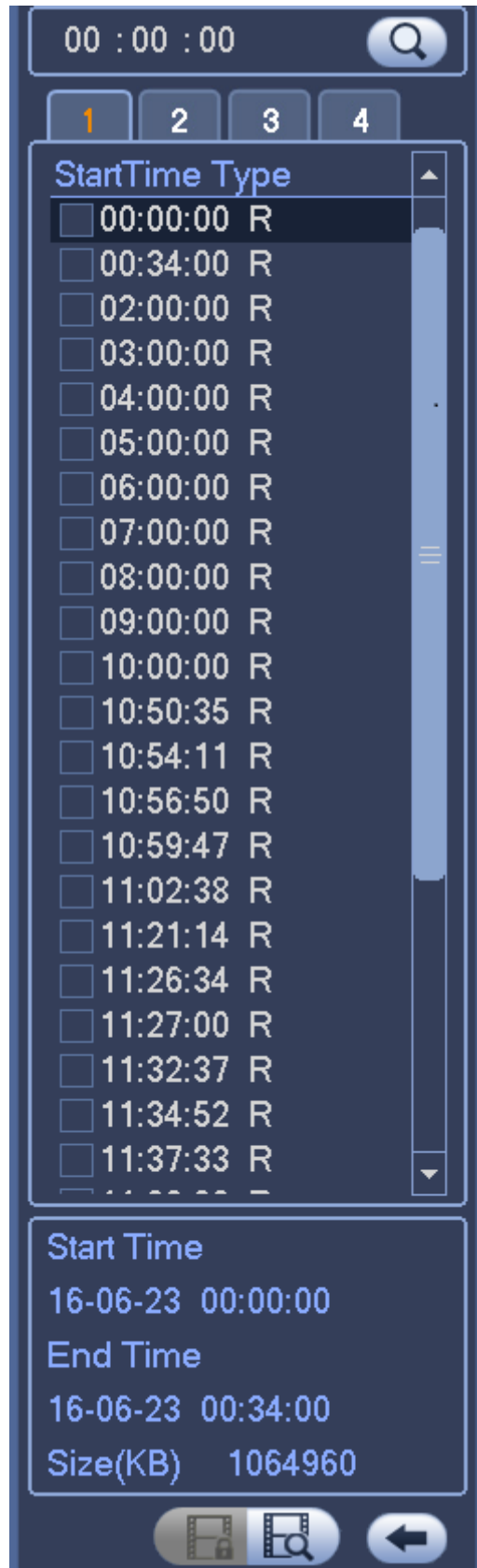



Figure 4-93

- Check a file name, double click file or click  to play.

- Input accurate time at the top column, you can search records of current day.
- System max displays 128 record files in one list.
- Click  to go back to the calendar/channel selection interface.

4.10.8 Lock or Unlock File

In Figure 4-93, select a file first and then click . You can lock it in case it is overwritten in the future.

Note

The file is writing or is overwriting can not be locked.

Click  you can view the locked file. See Figure 4-94.

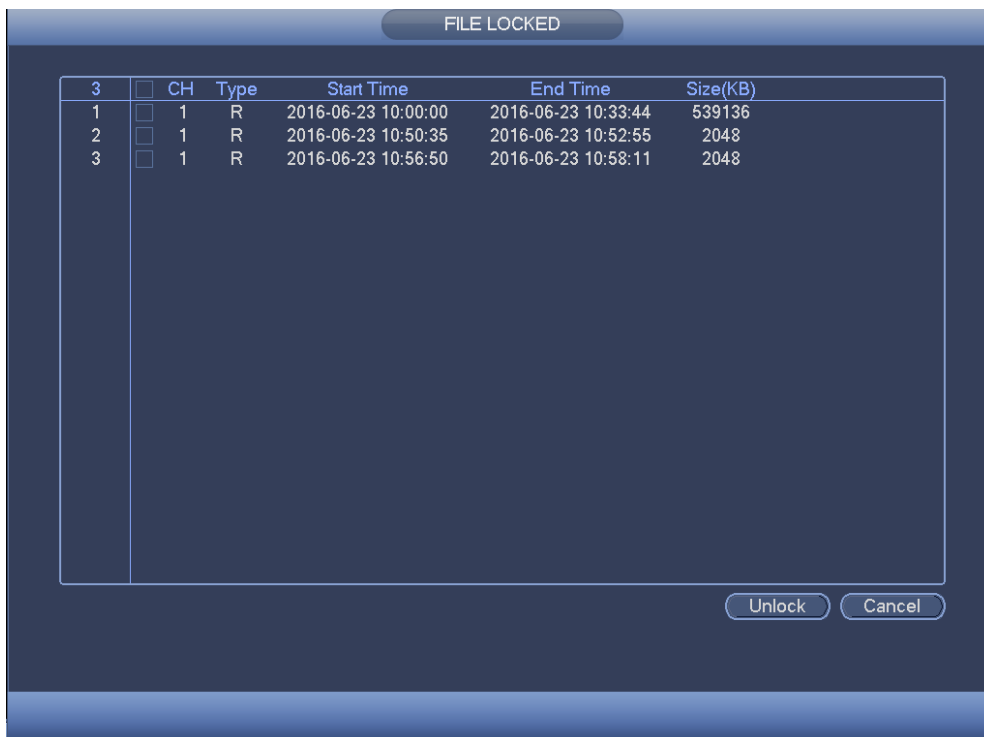

FILE LOCKED						
	<input type="checkbox"/>	CH	Type	Start Time	End Time	Size(KB)
3	<input type="checkbox"/>	1	R	2016-06-23 10:00:00	2016-06-23 10:33:44	539136
1	<input type="checkbox"/>	1	R	2016-06-23 10:50:35	2016-06-23 10:52:55	2048
2	<input type="checkbox"/>	1	R	2016-06-23 10:56:50	2016-06-23 10:58:11	2048
3	<input type="checkbox"/>	1	R			

Figure 4-94

Select a file in the above figure and then click Unlock, you can unlock it.

4.10.9 Other Aux Functions

4.10.9.1 Digital Zoom

In 1-window playback mode, left click mouse to select any zone on the screen, you can zoom in current zone. Right click mouse to exit.

4.10.9.2 Switch Channel

During playback mode, select from the dropdown list to switch playback channel. This function is not for the channel of no record. The smart search channel does not support this function either.

4.11 Backup

4.11.1 File Backup

In the main menu and then click Backup button, select file backup path, record type and etc, and then click Start, you can backup files to the corresponding path. See Figure 4-95.

Device Name

0.00 KB(Space Needed) 7.23 GB/7.32 GB(Free/Total)

Type

Start Time Record CH

End Time File Format

0	Channel	Type	Start Time	End Time	Size(KB)
---	---------	------	------------	----------	----------

Figure 4-95

4.11.2 USB Device Auto Pop-up

After you inserted the USB device, system can auto detect it and pop up the following dialogue box. It allows you to conveniently backup file, log, configuration or update system. See Figure 4-96. Please refer to chapter 4.11.1 File backup, chapter 4.21.4 Log, chapter 4.19.2 Import/export, and chapter 4.19.4 Upgrade for detailed information.



Figure 4-96

4.12 Network

4.12.1 TCP/IP

From main menu->Setting->Network->TCP/IP, you can go to the following interface.

The single network adapter interface is shown as in Figure 4-97 and the dual network adapters interface is shown as in Figure 4-98. For detailed information, please go to chapter 4.2.2.



Figure 4-97



Figure 4-98

4.12.2 Connection

From main menu->Setting->Network->Connection, the setup interface is shown as in Figure 4-99.

- Max connection: The max client login amount (such as WEB, platform, cellphone and etc). The value ranges from 1 to 128(default).
- TCP port: Default value is 37777.
- UDP port: Default value is 37778.
- HTTP port: Default value is 80. If you are using the browser to access the device, please add the corresponding port value if you have changed the default setup. Check the Enable box to enable this function.
- HTTPS port: Default value is 443. Check the box to enable HTTPS function.
- RTSP port: Default value is 554.
- POS port: Default value is 38800.

Important: System needs to reboot after you changed and saved any setup of the above five ports. Please make sure the port values here do not conflict.



Figure 4-99

4.12.3 WIFI

From main menu->Setting->Network->WIFI, the WIFI interface is shown as below. See Figure 4-100.

- Auto connect WIFI: Check the box here, system automatically connects to the previous WIFI hotspot.
- Refresh: You can click it to search the hotspot list again. It can automatically add the information such as the password if you have set it before.
- Disconnect: Here you can click it to turn off the connection.
- Connect: Here you can click it to connect to the hotspot. System needs to turn off current connection and then connect to a new hotspot if there is connection of you selected one.



Figure 4-100

- WIFI working status: Here you can view current connection status.

Please note:

- After successful connection, you can see WIFI connection icon at the top right corner of the preview interface.
- When the hotspot verification type is WEP, system displays as AUTO since the device can not detect its encryption type.
- System does not support verification type WPA and WPA2. The display may become abnormal for the verification type and encryption type.

After device successfully connected to the WIFI, you can view the hotspot name, IP address, subnet mask, default gateway and etc.

4.12.4 3G

From main menu->Setting->Network->3G, 3G setup interface is shown as below. See Figure 4-101.

Please refer to the following contents for the parameter information.

- Pane 1: Display 3G signal intensity after you enabled 3G function.
- Pane 2: Display 3G module configuration information after you enabled 3G function.
- Pane 3: Display 3G module status information after you enabled 3G function.

It is to display current wireless network signal intensity such as EVDO, CDMA1x, WCDMA, WCDMA, EDGE and etc.

- 3G module: It is to display current wireless network adapter name.
- 3G Enable/Disable: Check the box here to enable 3G module.

- Network type: There are various network types for different 3G network modules. You can select according to your requirements.
- APN: It is the wireless connection server. It is to set you access the wireless network via which method.
- AUTH: It is the authentication mode. It supports PAP/CHAP.
- Dial number: Please input 3G network dialup number you got from your ISP.
- User name: It is the user name for you to login the 3G network.
- Password: It is the password for you to login the 3G network.
- Pulse interval: You can set dialup duration. Once you disable the extra stream, the connection time begins. For example, if you input 5 seconds here, then 3G network connection period is 5 seconds. The device automatically disconnect when time is up. If there is no extra stream, 3G network connection is valid all the time. **If the alive time is 0, then the 3G network connection is valid all the time.**
- Dial: Here you can enable or disable 3G network connection/disconnection manually.
- 3G wireless network: Here is to display wireless network status, SIM card status, dial status. If the 3G connection is OK, then you can see the device IP address the wireless network automatically allocates.

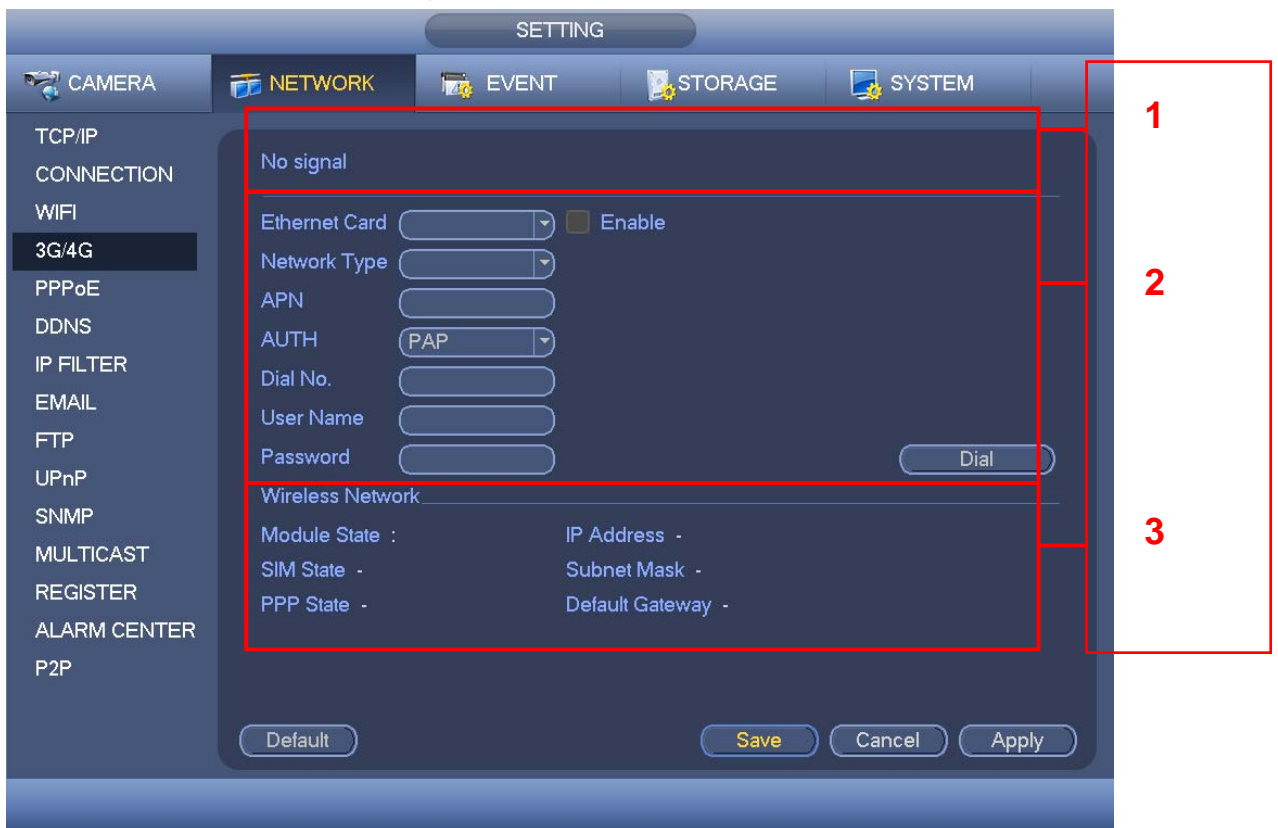

Figure 4-101

4.12.5 PPPoE

From main menu->Setting->Network->PPPoE, PPPoE interface is shown as in Figure 4-102.

Input "PPPoE name" and "PPPoE password" you get from your ISP (Internet service

provider).

Click save button, you need to restart to activate your configuration.

After rebooting, DVR will connect to internet automatically. The IP in the PPPoE is the DVR dynamic value. You can access this IP to visit the device.

Note

In this situation, the IP address in the main menu->Setting->Network->TCP/IP is read-only.

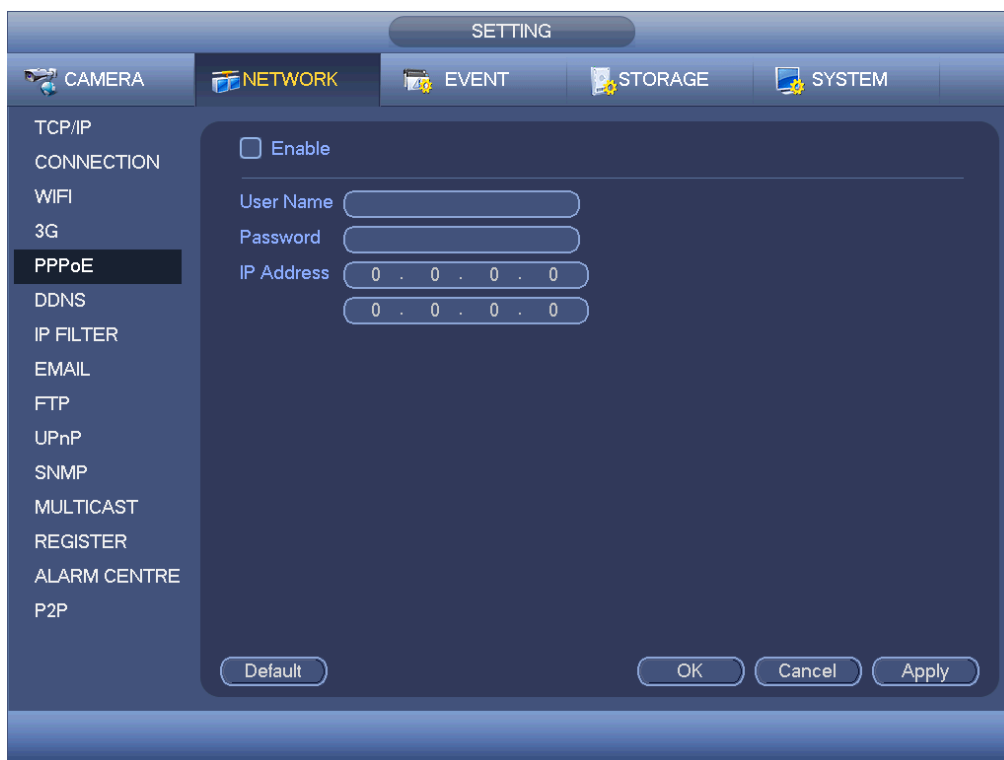

Figure 4-102

4.12.6 DDNS

From main menu->Setting->Network->DDNS, DDNS setup interface is shown as in Figure 4-103.

You need a PC of fixed IP in the internet and there is the DDNS software running in this PC. In other words, this PC is a DNS (domain name server).

In network DDNS, please select DDNS type and highlight enable item. And then please input your PPPoE name you get from you IPS and server IP (PC with DDNS). Click save button and then reboot system.

Click save button, system prompts for rebooting to get all setup activated.

After rebooting, open IE and input as below:

http: //(DDNS server IP)/(virtual directory name)/webtest.htm

e.g.: http: //10.6.2.85/DVR _DDNS/webtest.htm.)

Now you can open DDNSServer web search page.



Figure 4-103

Please note DDNS type includes: CN99 DDNS, NO-IP DDNS, Quick DDNS, Dyndns DDNS and sysdns DDNS. All the DDNS can be valid at the same time, you can select as you requirement.

Private DDNS function shall work with special DDNS server and special Professional Surveillance Software (PSS).

Quick DDNS and Client-end Introduction

1) Background Introduction

Device IP is not fixed if you use ADSL to login the network. The DDNS function allows you to access the DVR via the registered domain name. Besides the general DDNS ,the Quick DDNS works with the device from the manufacturer so that it can add the extension function.

2) Function Introduction

The quick DDNS client has the same function as other DDNS client end. It realizes the bonding of the domain name and the IP address. Right now, current DDNS server is for our own devices only. You need to refresh the bonding relationship of the domain and the IP regularly. There is no user name, password or the ID registration on the server. At the same time, each device has a default domain name (Generated by MAC address) for your option. You can also use customized valid domain name (has not registered.).

3) Operation

Before you use Quick DDNS, you need to enable this service and set proper server address, port value and domain name.

- Server address: www.quickddns.com

- Port number: 80
- Domain name: There are two modes: Default domain name and customized domain name.

Except default domain name registration, you can also use customized domain name (You can input your self-defined domain name.) After successful registration, you can use domain name to login installed of the device IP.

- User name: It is optional. You can input your commonly used email address.

Important

- Do not register frequently. The interval between two registrations shall be more than 60 seconds. Too many registration requests may result in server attack.
- System may take back the domain name that is idle for one year. You can get a notification email before the cancel operation if your email address setup is OK.

4.12.7 IP Filter

4.12.7.1 Access Right

From main menu->Setting->Network->IP filter->Access right, access right interface is shown as in Figure 4-104. You can add IP in the following list. The list supports max 64 IP addresses. System supports valid address of IPv4 and IPv6. **Please note system needs to check the validity of all IPv6 addresses and implement optimization.**

After you enabled trusted sites function, only the IP listed below can access current DVR. If you enable blocked sites function, the following listed IP addresses can not access current DVR.

- Enable: Highlight the box here, you can check the trusted site function and blocked sites function. You can not see these two modes if the Enable button is grey.
- Type: You can select trusted site and blacklist from the dropdown list. You can view the IP address on the following column.
- Start address/end address: Select one type from the dropdown list, you can input IP address in the start address and end address. Now you can click Add IP address or Add IP section to add.
 - a) For the newly added IP address, it is in enable status by default. Remove the before the item, and then current item is not in the list.
 - b) System max supports 64 items.
 - c) Address column supports IPv4 or IPv6 format. If it is IPv6 address, system can optimize it. For example, system can optimize aa:0000: 00: 00aa: 00aa: 00aa: 00aa: 00aa as aa:: aa: aa: aa: aa: aa: aa.
 - d) System automatically removes space if there is any space before or after the newly added IP address.
 - e) System only checks start address if you add IP address. System check start address and end address if you add IP section and the end address shall be larger than the start address.
 - f) System may check newly added IP address exists or not. System does not add if input IP address does not exist.
- Delete: Click it to remove specified item.

- Edit: Click it to edit start address and end address. See Figure 4-105. System can check the IP address validity after the edit operation and implement IPv6 optimization.
- Default: Click it to restore default setup. In this case, the trusted sites and blocked sites are both null.

Note:

- If you enabled trusted sites, only the IP in the trusted sites list can access the device.
- If you enabled blocked sites, the IP in the blocked sites can not access the device.
- System supports add MAC address.

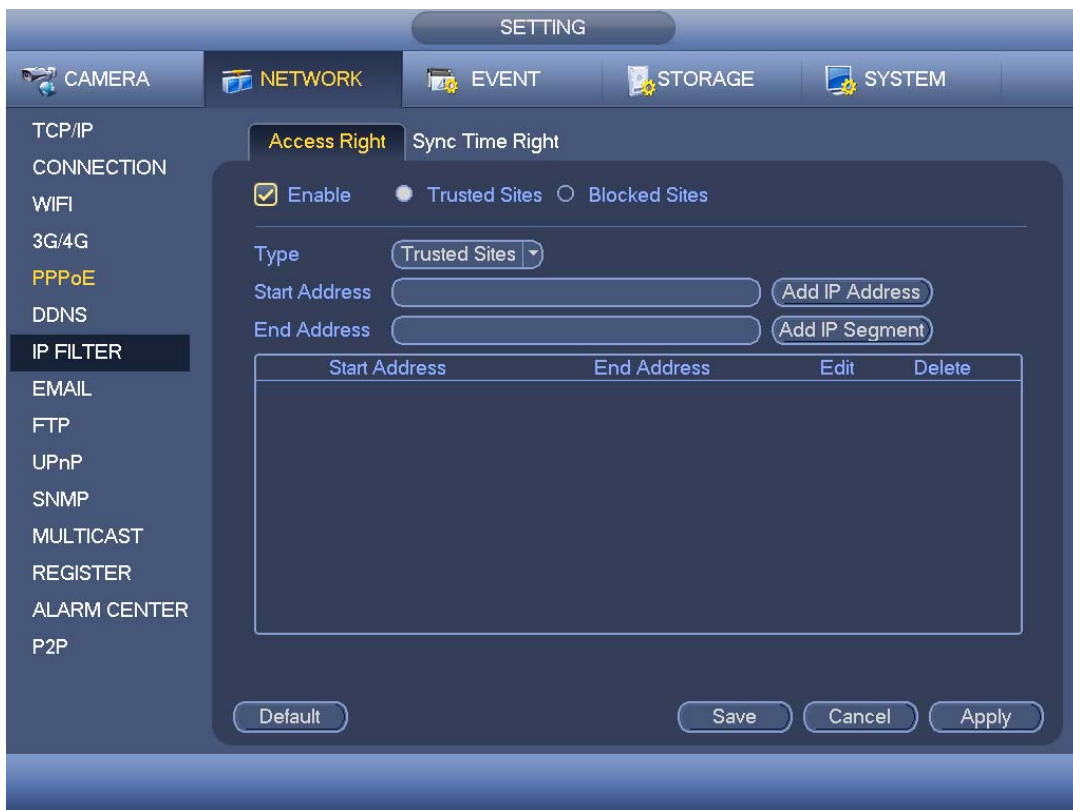

Figure 4-104

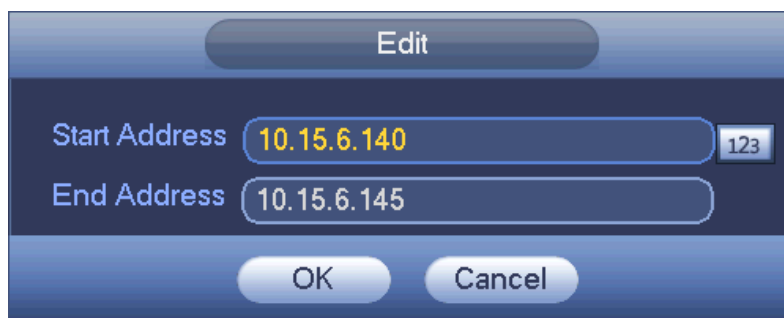

Figure 4-105

4.12.7.2 Sync Time Right

From main menu->Setting->Network->IP filter->Sync time right, you can go to the following interface. See Figure 4-106.

After you set sync time whitelist, only the specified IP address can sync or change device

time. It is to avoid multiple hosts to sync or change time with the device at the same time. Please check the Enable box to enable this function and then select blacklist or whitelist from the dropdown list. Please refer to 4.12.7.1 for setup information.

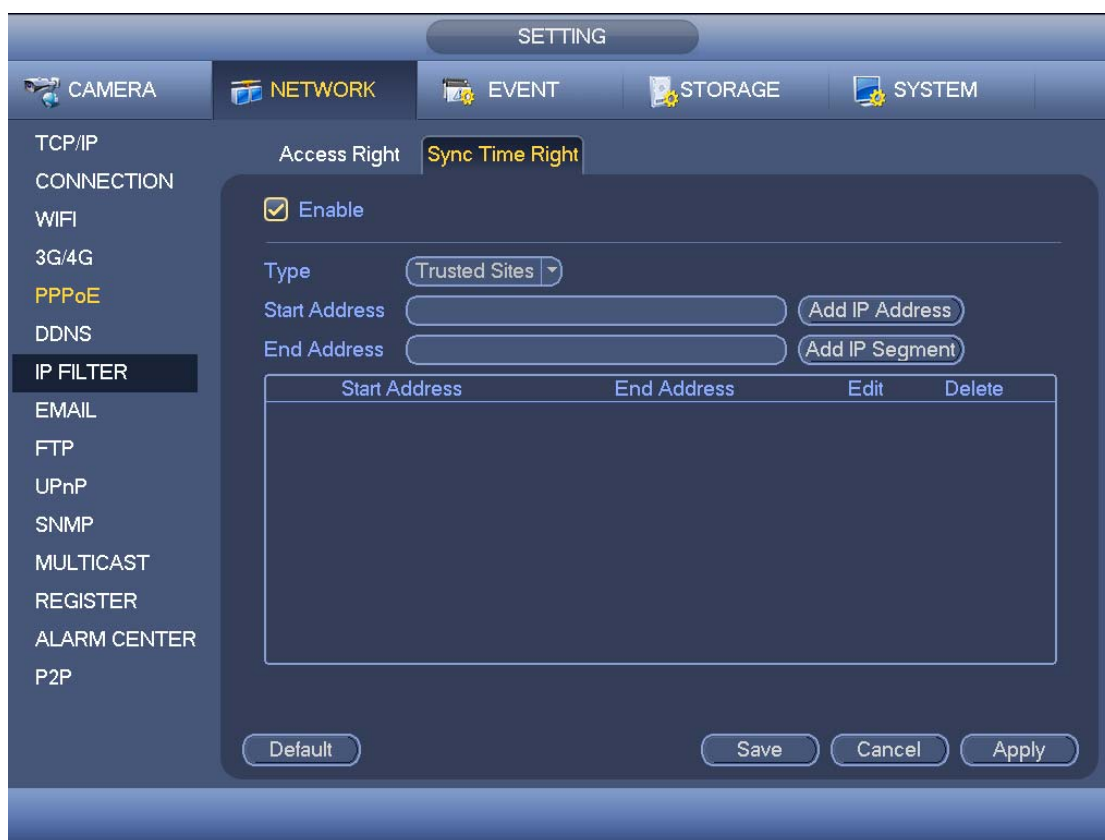

Figure 4-106

Note

If the DVR has enabled NTP service, the device will sync time with the NTP server regularly. The sync or change time operation of the IP address in the whitelist will be invalid, unless the NTP server and the IP address in the whitelist is the same.

4.12.8 Email

After you set email function, system can send out an email once there is an alarm, video detection event, abnormality event, intelligent event and etc.

From main menu->Setting->Network->Email, the email interface is shown as below. See Figure 4-107.

- SMTP server: Please input your email SMTP server IP here.
- Port: Please input corresponding port value here.
- User name: Please input the user name to login the sender email box.
- Password: Please input the corresponding password here.
- Sender: Please input sender email address here.
- Title: Please input email subject here. System support English character and Arabic number. Max 32-digit.

- Receiver: Please input receiver email address here. System max supports 3 email addresses. System automatically filters same addresses if you input one receiver repeatedly.
- Encryption type: System supports NONE, SSL and TLS.
- Interval: Please check the above box to enable this function and then set the corresponding interval. System can send out the email regularly as you set here. Click the Test button, you can see the corresponding dialogue box to see the email connection is OK or not. Please note system will not send out the email immediately when the alarm occurs. When the alarm, motion detection or the abnormality event activates the email, system sends out the email according to the interval you specified here. This function is very useful when there are too many emails activated by the abnormality events, which may result in heavy load for the email server.
- Health email enable: Please check the box here to enable this function. This function allows the system to send out the test email to check the connection is OK or not.
- Health email interval: The value ranges from 30 to 14440 minutes. System can send out the email to test as the interval you set here.



Figure 4-107

4.12.9 FTP

You need to download or buy FTP service tool (such as Ser-U FTP SERVER) to establish FTP service.

Please install Ser-U FTP SERVER first. From “start” -> “program” -> Serv-U FTP Server -> Serv-U Administrator. Now you can set user password and FTP folder. Please note you

need to grant write right to FTP upload user. See Figure 4-108.

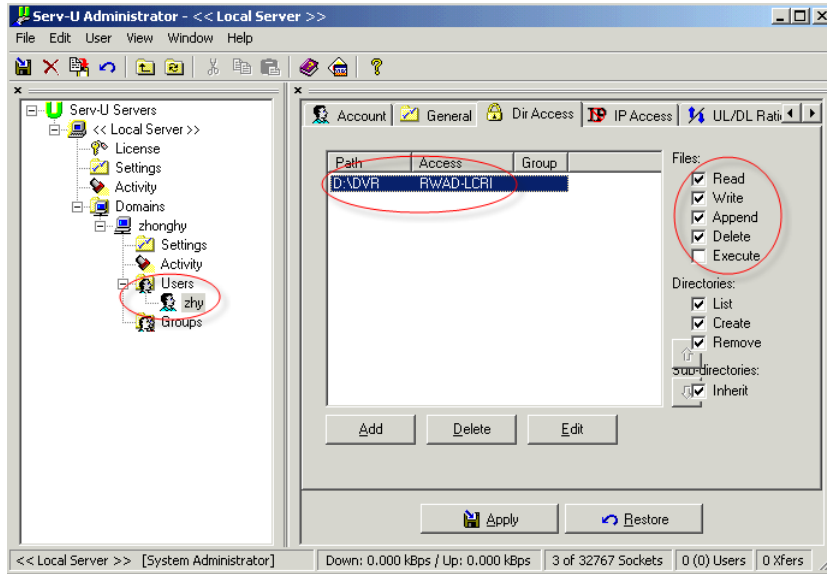

Figure 4-108

You can use a PC or FTP login tool to test setup is right or not.

For example, you can login user ZHY to FTP://10.10.7.7 and then test it can modify or delete folder or not. See Figure 4-109.



Figure 4-109

System also supports upload multiple DVRs to one FTP server. You can create multiple folders under this FTP.

From main menu->Setting->Network->CTP, you can go to the FTP interface. See Figure 4-110.

Please highlight the icon  in front of Enable to activate FTP function.

Here you can input FTP server address, port and remote directory. When remote directory is null, system automatically create folders according to the IP, time and channel.

- Host IP: The host IP you have installed the FTP server.
- Host port: The default setup is 21.
- User name/Password: The account for you to access the FTP server.

- Remote directory: The folder you created under the root path of the FTP according to the corresponding rule.
 - ✧ If there is no remote directory, system can auto create different directories according to the IP, time and channel.
 - ✧ If there is remote directory, system can create corresponding folder under the FTP root path and then create different folders according to IP address, time and channel.
- File length: File length is upload file length. When setup is larger than the actual file length, system will upload the whole file. When setup here is smaller than the actual file length, system only uploads the set length and auto ignore the left section. When interval value is 0, system uploads all corresponding files.
- Image upload interval: It is the image upload interval. If the image upload interval is larger than the image snapshot frequency, system just uploads the lasted image.
 - ✧ If the image interval is 5 seconds and the snapshot frequency is 2 seconds, system will send out the latest image at the buffer at 5 seconds.
 - ✧ If the image upload interval is smaller than the snapshot frequency, system will upload at the snapshot frequency. For example, if the image interval is 5 seconds and the snapshot frequency is 10 seconds, system will send out the image at 10 seconds.
 - ✧ From main menu->Setting->Camera->Encode->Snapshot to set snapshot frequency.
- Channel: Select a channel from the dropdown list and then set week, period and record type.
- Week day/Period: Please select from the dropdown list and for each day, you can set two periods.
- Type: Please select uploaded record type (Alarm/intelligent/motion detect/regular). Please check the box to select upload type.

Click the Test button, you can see the corresponding dialogue box to see the FTP connection is OK or not.



Figure 4-110

4.12.10 UPnP

The UPNP protocol is to establish a mapping relationship between the LAN and the WAN. Before you use this function, please:

- Login the router, set router WAN IP address.
- Enable router UPnP function.
- Connect the DVR with the LAN port of the router.

Please input the router IP address in the LAN in Figure 4-97 (main menu->Setting->Network->TCP/IP).

From main menu->Setting->Network->UPnP, you can go to the following interface. See Figure 4-111.

- UPNP Enable/Disable: Turn on or off the UPNP function of the device.
- Status: When the UPNP is offline, it shows as “Searching”. When the UPNP works it shows “Success”
- Router LAN IP: It is the router IP in the LAN.
- WAN IP: It is the router IP in the WAN.
- Port Mapping list: The port mapping list here is the one to one relationship with the router’s port mapping setting.
- List:
 - ✧ Service name: Defined by user.
 - ✧ Protocol: Protocol type
 - ✧ Internal port: Port that has been mapped in the router.
 - ✧ External port: Port that has been mapped locally.
- Default: UPNP default port setting is the HTTP, TCP and UDP of the DVR.

- Add to the list: Click it to add the mapping relationship.
- Delete: Click it to remove one mapping item.

Double click one item; you can change the corresponding mapping information. See Figure 4-112.

Important:

When you are setting the router external port, please use 1024~5000 port. Do not use well-known port 1~255 and the system port 256~1023 to avoid conflict.

For the TCP and UDP, please make sure the internal port and external port are the same to guarantee the proper data transmission.



Figure 4-111



Figure 4-112

4.12.11 SNMP

SNMP is an abbreviation of Simple Network Management Protocol. It provides the basic network management frame of the network management system. The SNMP widely used in many environments. It is used in many network device, software and system. From main menu->Setting->Network->SNMP, you can set in the following interface. See Figure 4-113.

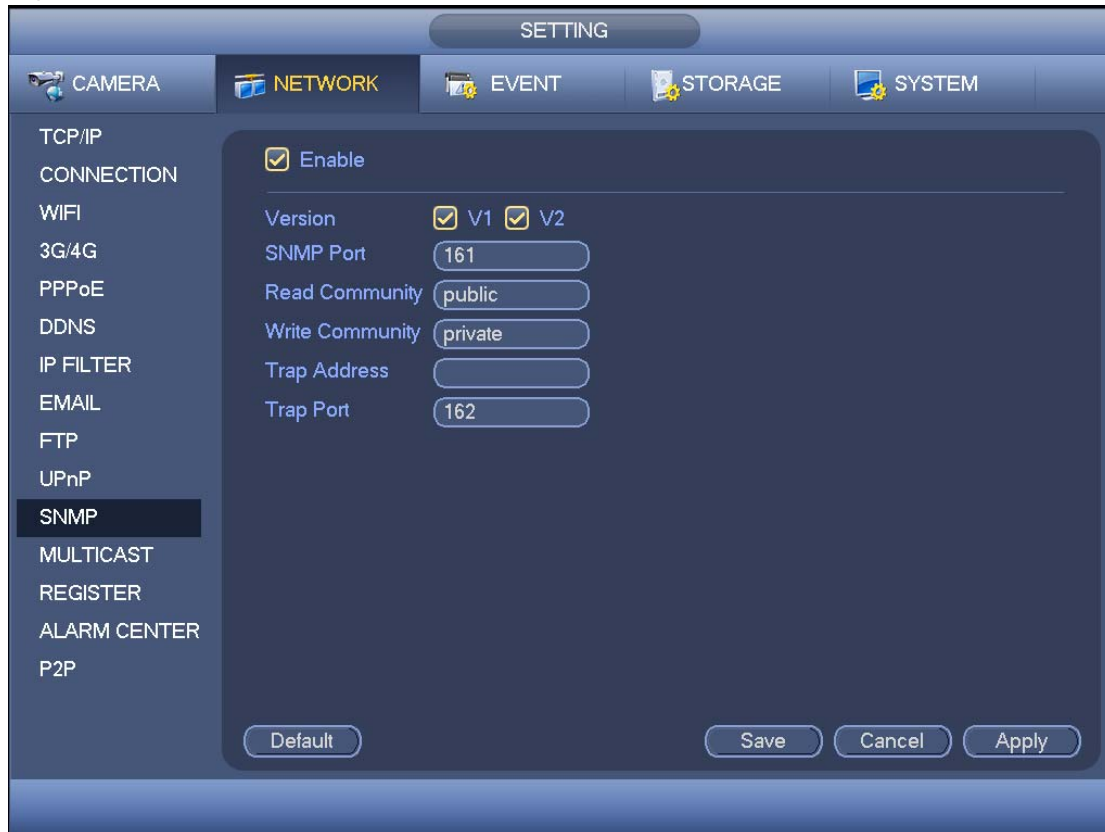

Figure 4-113

Please enable the SNMP function. Use the corresponding software tool (MIB Builder and MG-SOFT MIB Browser). You still need two MIB file: BASE-SNMP-MIB, DVR-SNMP-MIB) to connect to the device. You can get the device corresponding configuration information after successfully connection.

- Version: Check the box and then select version. DVR can process the corresponding version information.
- SNMP port: The agent applications listening port on the DVR.
- Read/write community: The read/write community string the agent applications supports.
- Trap address: The Trap information destination address of the agent applications on the DVR.
- Trap port: The Trap information destination port of the agent applications on the DVR.

Please follow the steps listed below to configure.

- In Figure 4-113, check the box to enable the SNMP function. Input the IP address of the PC than is running the software in the Trap address. You can use default setup for the rest items.

- Compile the above mentioned two MIB file via the software MIB Builder.
- Run MG-SOFT MIB Browser to load the file from the previous step to the software.
- Input the device IP you want to manage in the MG-SOFT MIB Browser. Please set the corresponding version for your future reference.
- Open the tree list on the MG-SOFT MIB Browser; you can get the device configuration. Here you can see the device has how many video channels, audio channels, application version and etc.

Note

Port conflict occurs when SNMP port and Trap port are the same.

4.12.12 Multicast

From main menu->Setting->Network->Multicast, multicast setup interface is shown as in Figure 4-114.

- Enable: Check the box here to enable multicast function.
- IP address: The multicast IP address (0.0.0.0~255.255.255.255).
- Port: The multicast port value(1025~65000).



Figure 4-114

Here you can set a multiple cast group. Please refer to the following sheet for detailed information.

- IP multiple cast group address
-224.0.0.0-239.255.255.255
-“D” address space
 - The higher four-bit of the first byte=“1110”
- Reserved local multiple cast group address

-224.0.0.0-224.0.0.255

-TTL=1 When sending out telegraph

-For example

224.0.0.1 All systems in the sub-net

224.0.0.2 All routers in the sub-net

224.0.0.4 DVMRP router

224.0.0.5 OSPF router

224.0.0.13 PIMv2 router

- Administrative scoped addressees

-239.0.0.0-239.255.255.255

-Private address space

- Like the single broadcast address of RFC1918
- Can not be used in Internet transmission
- Used for multiple cast broadcast in limited space.

Except the above mentioned addresses of special meaning, you can use other addresses.

For example:

Multiple cast IP: 235.8.8.36

Multiple cast PORT: 3666.

Use WEB to login, you can see the following interface. See Figure 4-118. Select login type as the Multicast from the dropdown list. After you logged in the Web, the Web can automatically get multiple cast address and add it to the multiple cast groups. You can enable real-time monitor function to view the video.

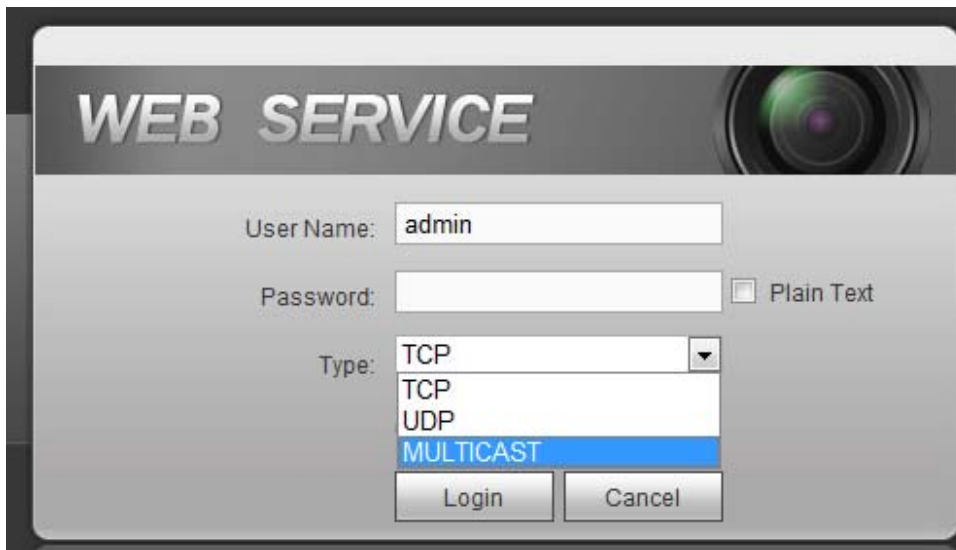

Figure 4-115

4.12.13 Auto register

This function allows the device to auto register to the proxy you specified. In this way, you can use the client-end to access the DVR and etc via the proxy. Here the proxy has a switch function. In the network service, device supports the server address of IPv4 or domain.

- Server IP address: The server IP address or server domain name you want to register.
- Port: The auto registration port value of the server.
- ID: The device ID allocated by the server.
- Please follow the steps listed below to use this function.

Please set proxy server address, port, and sub-device name at the device-end. Please enable the auto register function, the device can auto register to the proxy server.

1) From main menu->Setting->Network->Register, the setup interface is shown as in Figure 4-116.

Important

Do not input network default port such as TCP port number.

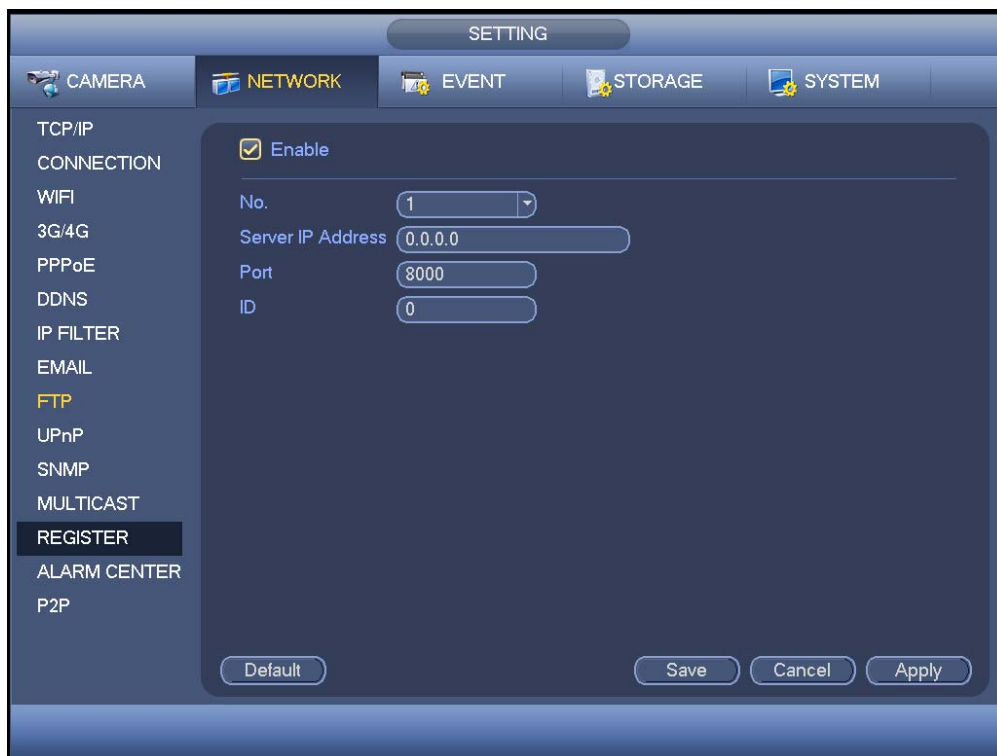

Figure 4-116

2) The proxy server software developed from the SDK. Please open the software and input the global setup. Please make sure the auto connection port here is the same as the port you set in the previous step.

3) Now you can add device. Please do not input default port number such as the TCP port in the mapping port number. The device ID here shall be the same with the ID you input in Figure 4-116. Click Add button to complete the setup.

4) Now you can boot up the proxy server. When you see the network status is Y, it means your registration is OK. You can view the proxy server when the device is online.

Important

The server IP address can also be domain. But you need to register a domain name before you run proxy device server.

4.12.14 Alarm Centre

Here you can set alarm center server. Once there is an alarm event, system can send out the alarm to the alarm center. Please refer to chapter 4.15 Alarm events to set upload function.

From main menu->Setting->Network->Alarm center, you can go to the following interface. See Figure 4-117.

- Enable: Check the box to enable alarm center function.
- Host IP/Port: The IP address and the communication port of the PC that have installed the alarm client.
- Self-report time: Select alarm upload time from the dropdown list.



Figure 4-117

4.12.15 P2P

You can use cellphone client or the management platform to access the device.

- You can use your cell phone to scan the QR code and add it to the cell phone client.
- Via the SN from scanning the QR code, you can access the device in the WAN.

Please refer to the P2P operation manual included in the resources CD.

From main menu->Setting->Network->P2P, you can go to the following interface, the P2P interface is shown as in Figure 4-118.





Figure 4-118

- Android:
Open Google Play app in your smart phone. Search gDMSS Lite or gDMSS Plus, download it and install.
- iOS:
Open App Store app in your smart phone. Search iDMSS Lite or iDMSS Plus, download it and install.

Please follow the steps listed below.



- Open App; tap  to go to the Live preview.
- Tap  at the top left corner, you can see the main menu.
- Tap Device manager button, you can use several modes (P2P/DDNS/IP and etc) to add the device. Click  to save current setup. Tap Start Live preview to view all-channel video from the connected device. See Figure 4-13.

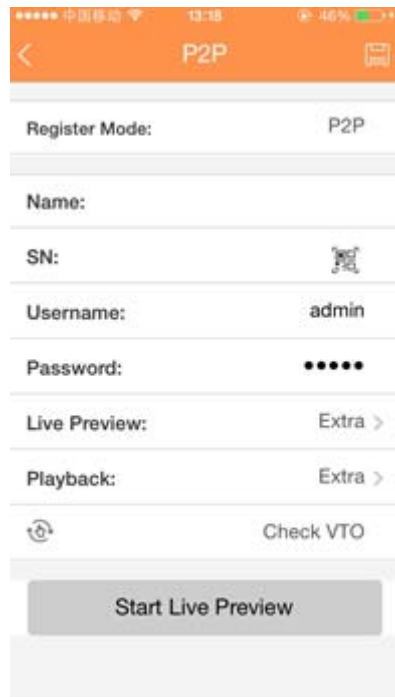

Figure 4-119

4.13 Account Manager

Here is to manage users, user group and ONVIF user, set admin security questions.

For account management please note:

- For the user name, the string max length is 31-byte, and for the user group, the string max length is 15-byte. The backspace in front of or at the back of the string is invalid. There can be backspace in the middle. The string includes the valid character, letter, number, underline, subtraction sign, and dot.
- The default user amount is 64 and the default group amount is 20. System account adopts two-level management: group and user. No limit to group or user amount.
- For group or user management, there are two levels: admin and user. The user name shall be unique and one user shall only belong to one group.

4.13.1 Add User

From main menu->Setting->System->Account->User, you can go to the following interface. See Figure 4-120.



Figure 4-120

Click modify user button  in Figure 4-120 , the interface is shown as in Figure 4-121. Please input the user name, password, select the group it belongs to from the dropdown list. Then you can check the corresponding rights for current user. For convenient user management, usually we recommend the general user right is lower than the admin account.

- **Username:** admin. **Password:** admin. (administrator, local and network)
- **Username:** 888888. **Password:** 888888. (administrator, local only)
- **Username:** default. **Password:** default (hidden user). Hidden user “default” is for system interior use only and can not be deleted. When there is no login user, hidden user “default” automatically login. You can set some rights such as monitor for this user so that you can view some channels without login.

Figure 4-121

When you create a new user, you can input the corresponding MAC address of current user. If you leave this item in blank, any MAC address user can share this user account to login. Please note system needs to check the validity of MAC. Only the 12-digit 0-f format address can pass the validity verification. System only saves small character even you input capitalized one. You can see the corresponding prompt if there is any illegal input.

Click the Set button after the period, you can set valid period to use current account. See Figure 4-122.

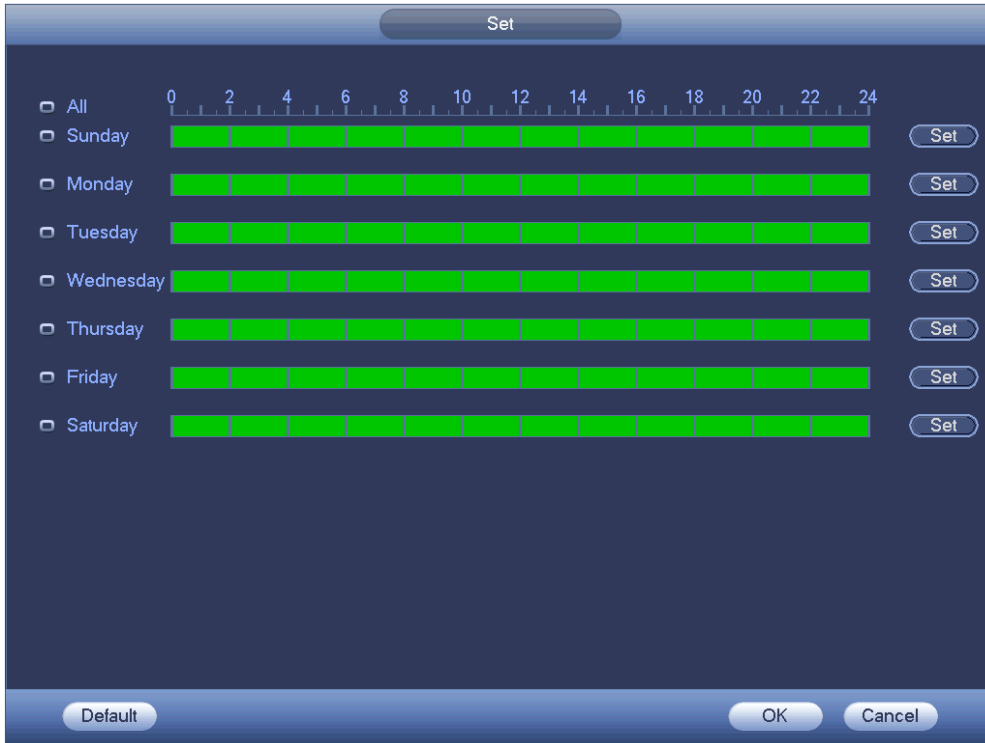



Figure 4-122

Click Set button, you can set six periods in one day. See Figure 4-123.
 Check the box after the period, you can enable current setup.



Figure 4-123

4.13.2 Modify user

From main menu->Setting->System->Account->User, click , you can go to the following interface to change user information. See Figure 4-124.

For admin, 888888, and default (hidden user), you can not change period setup.



The screenshot shows the 'Modify User' interface. It features a dark blue background with white text and input fields. The 'User Name' dropdown is set to 'default'. The 'Group' dropdown is set to 'user'. The 'Memo' field contains 'default account'. The 'Authority' section is currently on the 'System' tab, showing a grid of permissions with checkboxes. At the bottom, there are 'Save' and 'Cancel' buttons.

Figure 4-124

4.13.3 Change Password

In Figure 4-124, check the Modify password box, you can change password. Please input old password, and then input new password twice to confirm.

The password can contain 32-byte and the space at the beginning or at the end of the password are null. It can contain in the middle of the password. For the user of account right, it can change the password of other users.

4.13.4 Add/Modify Group

From main menu->Setting->System->Account->Group, you can see the following interface. See Figure 4-125.

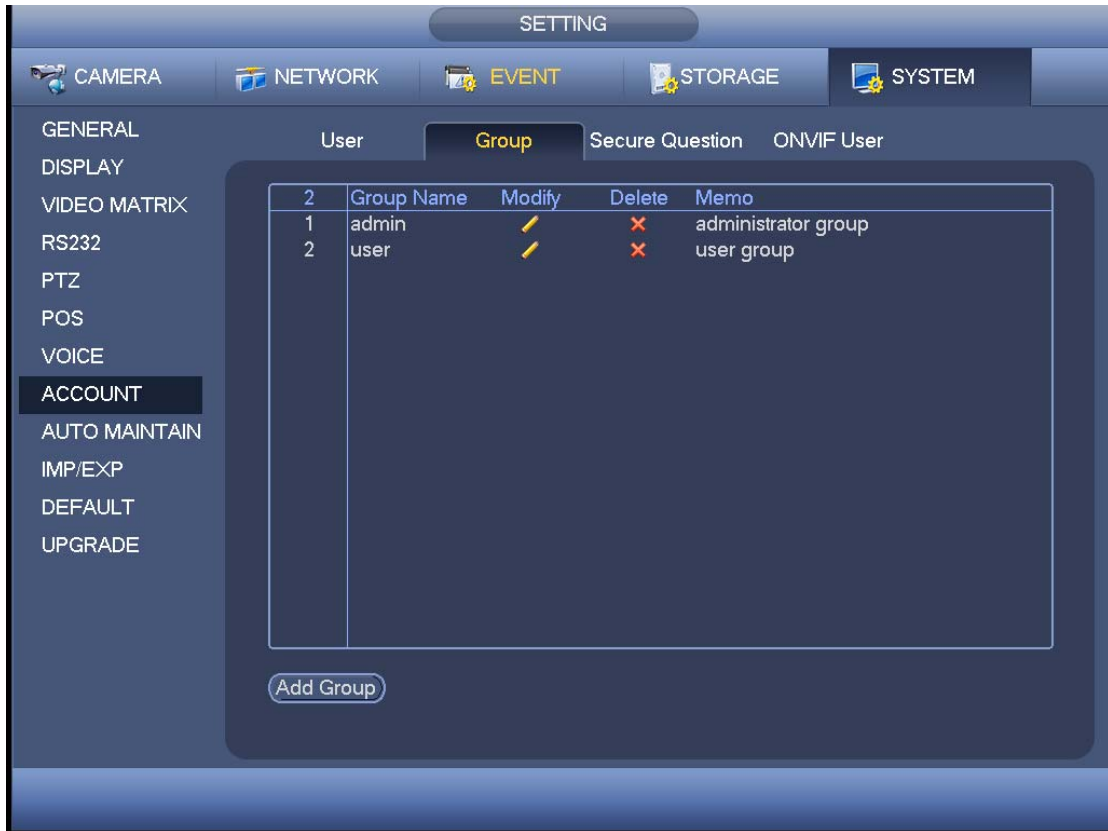

Figure 4-125

Click add group button in Figure 4-125 , the interface is shown as below. See Figure 4-126.

Here you can input group name and then input some memo information if necessary. There are total 98 rights such as control panel, shut down, real-time monitor, playback, record, record file backup, PTZ, user account, system information view, alarm input/output setup, system setup, log view, clear log, upgrade system, control device and etc.



Figure 4-126

4.13.5 Security Question

From main menu->Setting->System->Account->Security question, the interface is shown as below. See Figure 4-127. Here you can change security questions. After you successfully answered security questions, you can reset admin account password (Chapter 4.1.3).

Input correct security answers and then click Delete button at the bottom of the interface, you can reset security questions and answers.

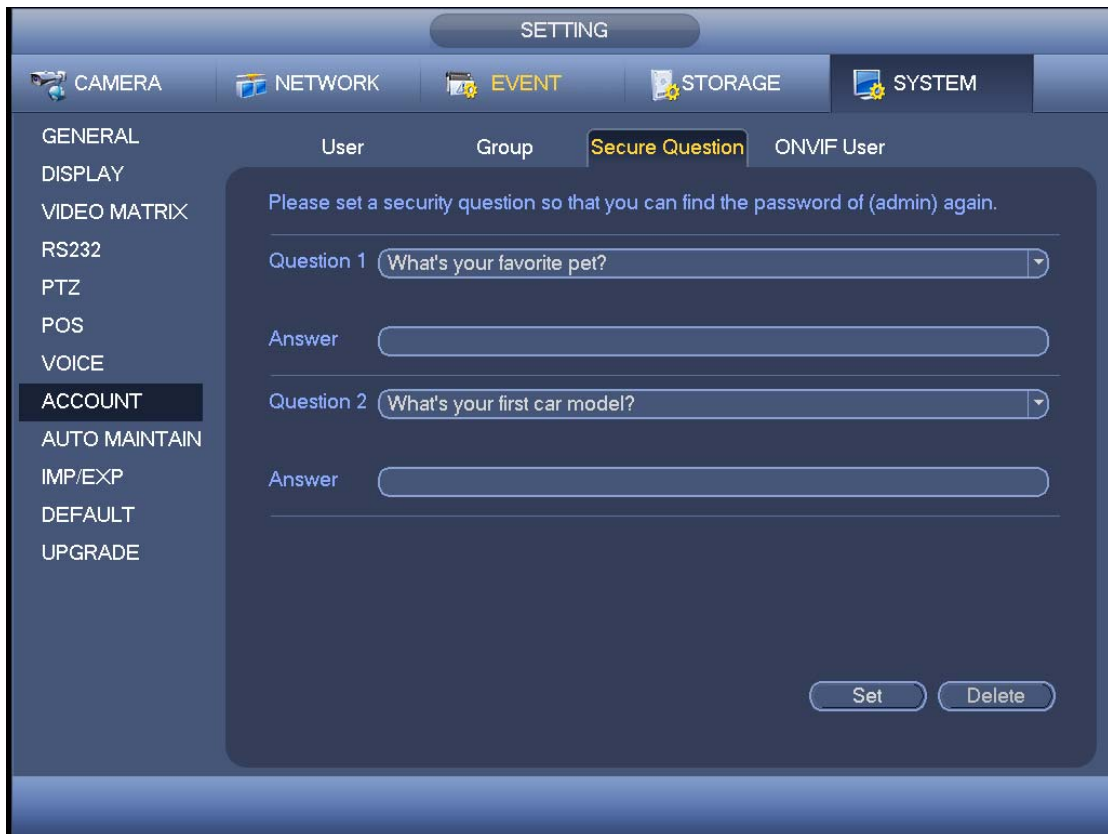

Figure 4-127

4.13.6 ONVIF User

When the camera from the third party is connected with the DVR via the ONVIF user, please use the verified ONVIF account to connect to the DVR. From main menu->Setting->System->Account->ONVIF User, you can add/delete/modify user. See Figure 4-128.

Note

The default ONVIF user is admin and the password is what you set in chapter 4.1.2. The account is read-only.

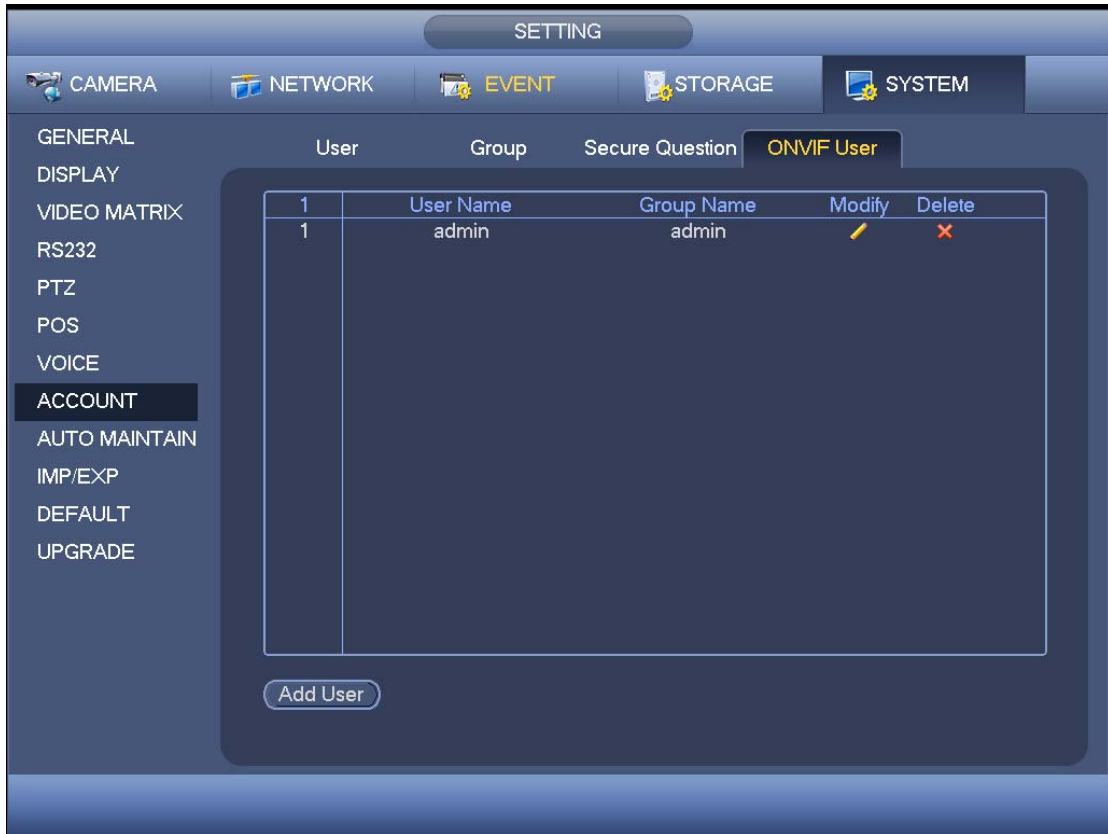

Figure 4-128

Click Add user button, you can see the following interface. See Figure 4-129.



Figure 4-129

Please set user name, password and then select group from the dropdown list. Click Save to complete setup.

Tips

Click  to change user information, click  to delete current user.

4.14 Voice Manager

The audio function is to manage audio files and set schedule play function. It is to realize audio broadcast activation function.

4.14.1 File List

From main menu->Setting->System->Voice->File List, Here you can add audio file, listen to the audio file, or rename/delete audio file. Here you can also set audio volume. See Figure 4-130.

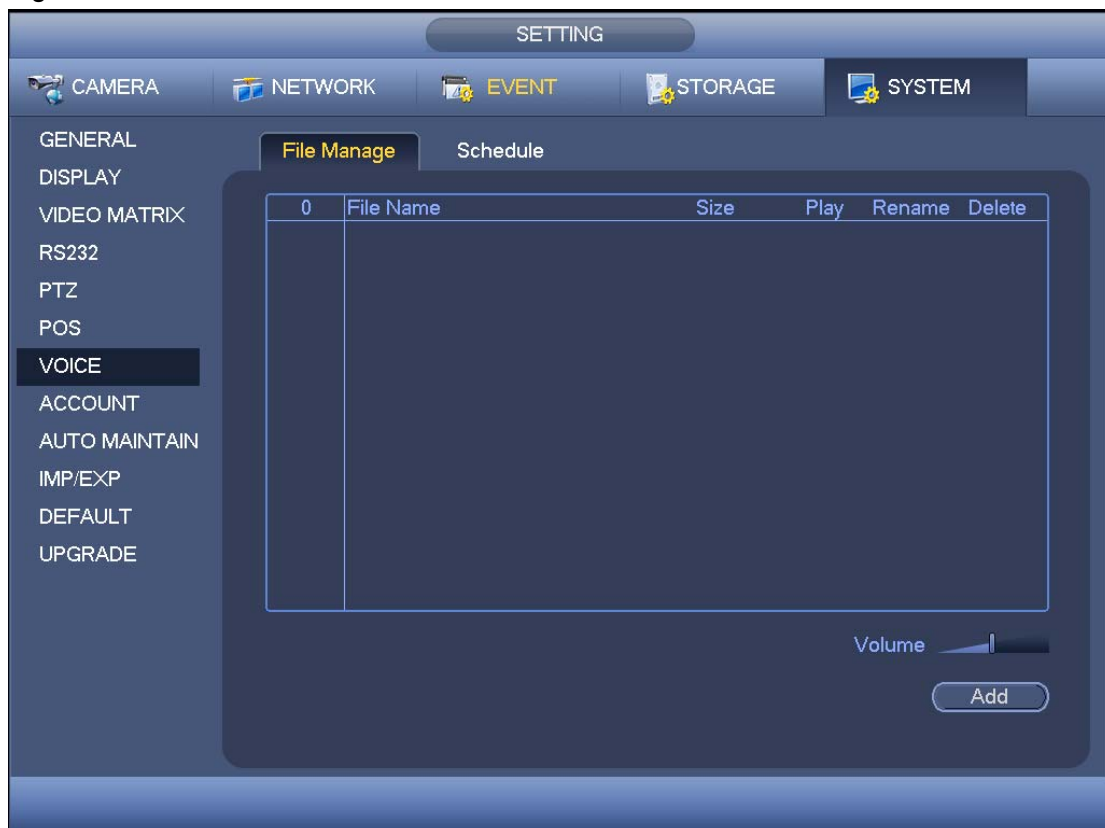

Figure 4-130

Click Add button, you can add audio file and import the audio file via the USB device. See Figure 4-131. The newly added audio file will be saved on the HDD of the device; you do not need to connect to USB device again.



Figure 4-131

The audio file can be saved on the HDD or on the USB device.

- In Figure 4-130, when it is HDD mode, the newly added audio file can be saved on the HDD automatically. You do not need to connect to the USB device if you want to use it the next time.
- In Figure 4-130, when it is USB mode, after you imported, you need to connect the USB device all the time; otherwise, the audio link function may fail. So, if you want to use the audio trigger function, please make sure the audio file is on the UBS device and the USB device has connected to the DVR before the DVR boots up. You need to make sure the USB device connection is always there if you want to manage and use the audio file function.
- If there is a USB device (containing the audio file) and the HDD (containing the audio file) at the same time, the HDD mode has higher priority. That is to say, DVR uses the audio file from the HDD.

4.14.2 Schedule

From main menu->Setting->System->Voice->Schedule, you can go to the following interface. It is to set schedule broadcast function. You can play the different audio files in the specified periods. See Figure 4-132.

- Period: There are six periods. Check the box to enable current setup.
- File name: Select audio file you want to play.
- Interval: It is the audio file repeated interval in the specified period.
- Repeat: It is to set audio file repeat times in the specified period.
- Output port: There are two options: MIC (default)/audio. When reuse the MIC port and bidirectional talk port, the bidirectional port has the higher priority. Please make sure your purchased product has audio port, otherwise, you can not use this function.

Note

- The audio file end time depends on the audio file size and the interval setup.
- Priority: Bidirectional talk>Event trigger alarm>Trial listening>Audio schedule

broadcast.



Figure 4-132

4.15 Alarm Events



Important

For the channel connected to the analog fisheye, the intelligent function is null. Please refer to the interface of your purchased product for detailed information.

4.15.1 Video Detect

4.15.1.1 Motion Detect

In the main menu, from Setting->Video detect->Motion detect, you can see motion detect interface. See Figure 4-133. There are five detection types: motion detection, video loss, tampering, scene change, diagnosis.

- The video loss has no detection region and sensitivity setup and tampering has no detection region setup.
- You can see motion detect icon if current channel has enabled motion detect alarm.
- You can drag you mouse to set motion detect region. Please click OK button to save current region setup. Right click mouse to exit current interface.
- For digital channel, the detect function refers to support detection function of the front-end and support local activation function. The front-end can get

enable/disable status, sensitivity and region setup. You can get corresponding prompt if front-end can not get the above information. You can change front-end setup if it can get.

4.15.1.1.1 Motion Detect

After analysis video, system can generate a video loss alarm when the detected moving signal reached the sensitivity you set here.

Detection menu is shown as below. See Figure 4-133.

- Event type: From the dropdown list you can select motion detection type.
- Channel: Select a channel from the dropdown list to set motion detect function.
- Enable: Check the box here to enable motion detect function.
- Region: Click select button, the interface is shown as in Figure 4-134. Here you can set motion detection zone. There are four zones for you to set. Please select a zone first and then left drag the mouse to select a zone. The corresponding color zone displays different detection zone. You can click Fn button to switch between the arm mode and disarm mode. In arm mode, you can click the direction buttons to move the green rectangle to set the motion detection zone. After you completed the setup, please click ENTER button to exit current setup. Do remember click save button to save current setup. If you click ESC button to exit the region setup interface system will not save your zone setup.
- Sensitivity: System supports 6 levels. The sixth level has the highest sensitivity.
- Anti-Dither: Here you can set anti-dither time. The value ranges from 5 to 600s. The anti-dither time refers to the alarm signal lasts time. It can be seem as the alarm signal activation stays such as the buzzer, tour, PTZ activation, snapshot, channel record. The stay time here does not include the latch time. During the alarm process, the alarm signal can begin an anti-dither time if system detects the local alarm again. The screen prompt, alarm upload, email and etc will not be activated. For example, if you set the anti-dither time as 10 second, you can see the each activation may last 10s if the local alarm is activated. During the process, if system detects another local alarm signal at the fifth second, the buzzer, tour, PTZ activation, snapshot, record channel will begin another 10s while the screen prompt, alarm upload, email will not be activated again. After 10s, if system detects another alarm signal, it can generate an alarm since the anti-dither time is out.
- Period: Click set button, you can see an interface is shown as in Figure 4-136. Here you can set motion detect period. System only enables motion detect operation in the specified periods. It is not for video loss or the tampering. There are two ways for you to set periods. Please note system only supports 6 periods in one day.

✧ In Figure 4-136, Select icon  of several dates, all checked items can be edited together. Now the icon is shown as . Click  to delete a record type from one period.

- ✧ In Figure 4-136. Click button  after one date or a holiday, you can see an interface shown as in Figure 4-137. There are four record types: regular, motion detection (MD), Alarm, MD & alarm.
- Alarm output: when an alarm occurs, system enables peripheral alarm devices.
 - Latch: when motion detection complete, system auto delays detecting for a specified time. The value ranges from 1-300(Unit: second)
 - Show message: System can pop up a message to alarm you in the local host screen if you enabled this function.
 - Alarm upload: System can upload the alarm signal to the network (including alarm center) if you enabled current function.
 - Send email: System can send out email to alert you when an alarm occurs.
 - Record channel: System auto activates motion detection channel(s) to record once an alarm occurs. Please make sure you have set MD record in Schedule interface(Main Menu->Setting->Schedule) and schedule record in manual record interface(Main Menu->Advanced->Manual Record)
 - PTZ activation: Here you can set PTZ movement when an alarm occurs. Such as go to preset, tour & pattern when there is an alarm. Click “select” button, you can see an interface is shown as in Figure 4-135.
 - Record Delay: System can delay the record for specified time after alarm ended. The value ranges from 10s to 300s.
 - Tour: Here you can enable tour function when alarm occurs. System one-window tour.
 - Snapshot: You can enable this function to snapshot image when a motion detect alarm occurs.
 - Video matrix: Check the box here to enable this function. When an alarm occurs, VIDEO OUTPUT port displays device video output. It displays video (1-window tour) from alarm activation channel you select at the Record channel interface. It has high priority than the tour setup in Main menu->Setting->System->Video matrix. Please note this function is for some series product only.
 - Buzzer: Highlight the icon to enable this function. The buzzer beeps when alarm occurs.
 - Log: Check the box here, system can record motion detect log.
 - Test: Click it to test current motion detect setup (do not need to save). Click Select button after Region, you can set motion detect area.
 - Voice prompts: Check the box here to trigger audio broadcast function. You can select specified audio file here. System can play the audio file once the corresponding event occurs.

Please highlight icon  to select the corresponding function. After you completed all the setups, please click Save button.

Note:

In motion detection mode, you can not use copy/paste to set channel setup since the video in each channel may not be the same.

In Figure 4-134, you can left click mouse and then drag it to set a region for motion detection. Click Fn to switch between arm/withdraw motion detection. After setting, click enter button to exit.



Figure 4-133

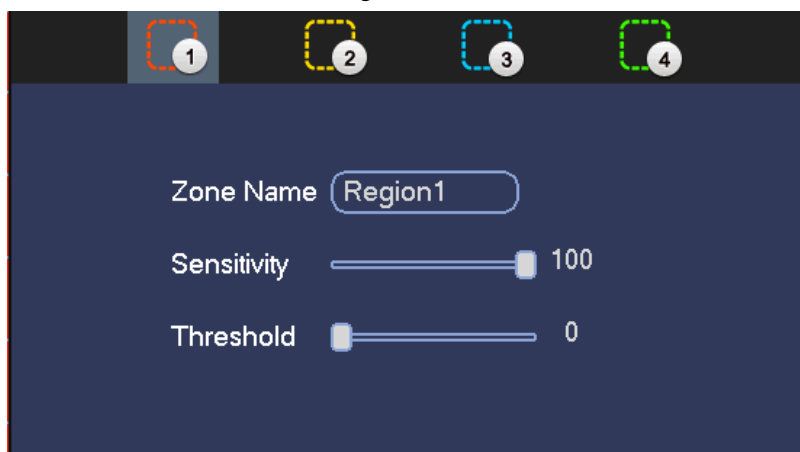

Figure 4-134

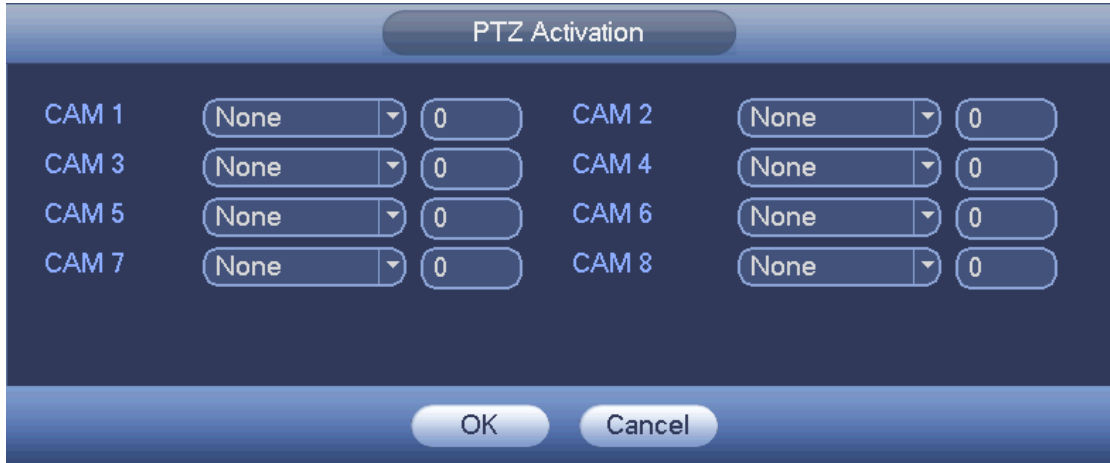

Figure 4-135



Figure 4-136



Figure 4-137

Motion detect here only has relationship with the sensitivity and region setup. It has no relationship with other setups.

4.15.1.1.2 Video Loss

In Figure 4-133, select video loss from the type list. You can see the interface is shown as in Figure 4-138. This function allows you to be informed when video loss phenomenon occurred. You can enable alarm output channel and then enable show message function.

Tips:

You can enable preset/tour/pattern activation operation when video loss occurs. Please refer to chapter 4.15.1.1.1 motion detection for detailed information.



Figure 4-138

4.15.1.1.3 Tampering

When someone viciously masks the lens, or the output video is in one-color due to the environments light change, the system can alert you to guarantee video continuity. Tampering interface is shown as in Figure 4-139. You can enable “Alarm output” or “Show message” function when tampering alarm occurs.

- Sensitivity: The value ranges from 1 to 6. It mainly concerns the brightness. The level 6 has the higher sensitivity than level 1. The default setup is 3.

Tips:

You can enable preset/tour/pattern activation operation when video loss occurs. Please refer to chapter 4.15.1.1.1 motion detection for detailed information.

Note:

- In Detect interface, copy/paste function is only valid for the same type, which means you can not copy a channel setup in video loss mode to tampering mode.
- About Default function. Since detection channel and detection type may not be the same, system can only restore default setup of current detect type. For example, if you click Default button at the tampering interface, you can only restore default tampering setup. It is null for other detect types.
- System only enables tampering function during the period you set here. It is null for motion detect or video loss type.



Figure 4-139

4.15.1.1.4 Scene Changing

When the detected scene has changed, system can generate an alarm.

From main menu->Setting->Event->Video detect->Scene change, the interface is shown as in Figure 4-140.

Please refer to chapter 4.15.1.1.1 motion detection for detailed information.

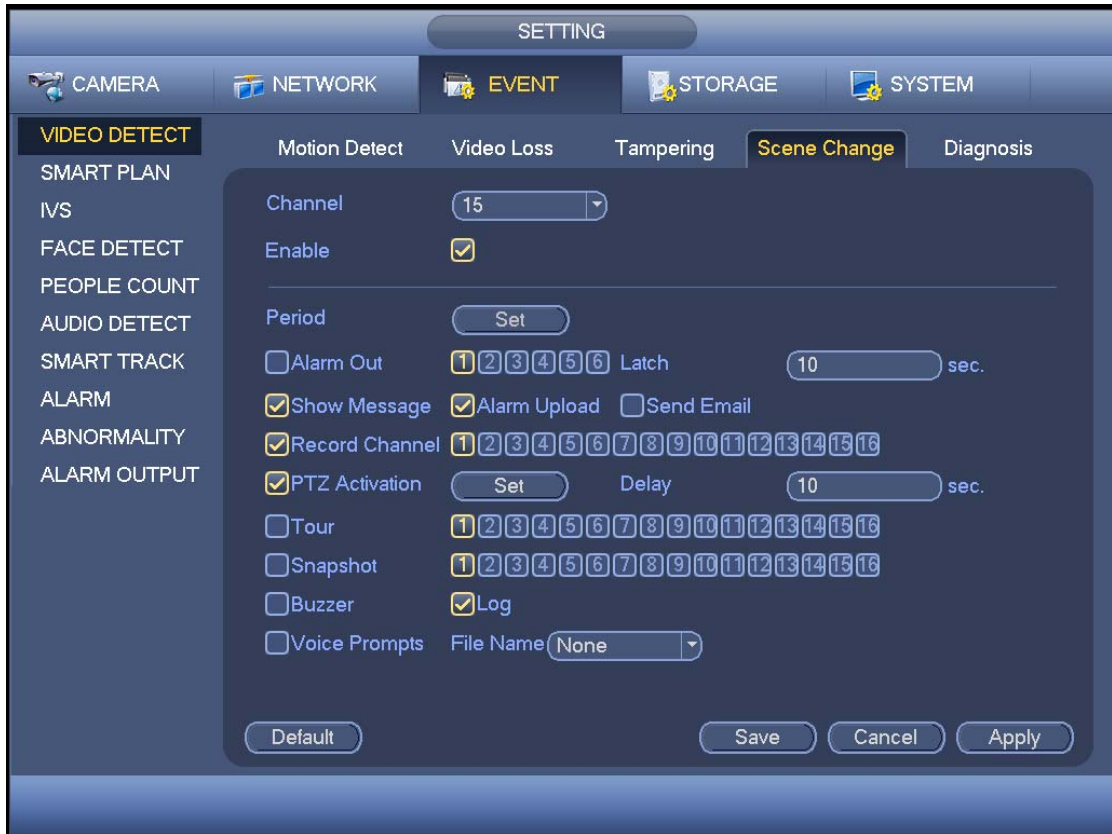

Figure 4-140

4.15.1.1.5 Diagnosis

Note

This function is for some series only.

System can trigger an alarm when the stripe, noise, color cast, out of focus, over exposure event occurred. See Figure 4-141.

Please refer to chapter 4.15.1.1.1 motion detection for detailed information.



Figure 4-141

This function allows you to be informed when video is blurry, over exposure or color cast occurs. You can enable alarm output channel and then enable show message function. Click the Rule Set button, or move the cursor to Set button and then click the Enter button on the front panel, the interface is shown as below. See Figure 4-142.

You can check corresponding type and then input alarm threshold.

- Stripe: The strip occurs when the device is old or there is electronic interference. There may be cross strip, vertical strip, slanting strip and etc.
- Noise: The video noise refers to the blurry video, poor video quality. It may result from the optical system distortion or the hardware problem during the video transmission when recording.
- Color cast: Usually the video is color containing RGB. When these three colors displayed in abnormal rate, we can say color cast occurred.
- Out of focus: The clear video presents abundant video details. The video definition decreases when the distortion event occurs. The out of focus event may result from many sources such as video transmission, processing and etc.
- Over exposure: The color brightness refers to the image pixel intensity. Black is the darkest and the white is the brightest. We use number 0 to stand for black and use number 255 to stand for white. Once the brightness threshold of the whole image has exceeded the threshold value, it means the image is over exposure.
- Threshold: The value ranges from 1 to 30. System can generate an alarm once the value is higher than the threshold you set here.



Figure 4-142

Note

Video analysis alarm can trigger PTZ preset, tour, and pattern.
Please refer to chapter 4.15.1.1.1 motion detection for detailed information.

4.15.2 Smart Plan (Optional)

Important

The smart plan is for the smart network camera. If you do not set a rule here, you can not use the intelligent functions in IVS (Chapter 4.15.3), Face detection (Chapter 4.15.4) and People counting (Chapter 4.15.4) when you are connecting to a smart network camera.

In this interface, you can quickly add an intelligent rule for one preset. The intelligent rule includes human face detection, behavior analytics and people counting.
From main menu->Setting->Event->Smart plan, the interface is shown as below. See Figure 4-143.



Figure 4-143

Please select a channel number from the dropdown list and set the smart plan. Click OK to complete the setup.

4.15.3 IVS (Optional)



Please contact your service engineer or local retailer if you cannot use IVS function.

Once any object violate the rule, the DVR can trigger an alarm and alert you as the specified alarm mode.

From main menu->Setting->Event->IVS, you can go to the following interface. Here you can set IVS rule. System can generate an alarm as the mode you previously set once there is any object violates the rule. See Figure 4-144.

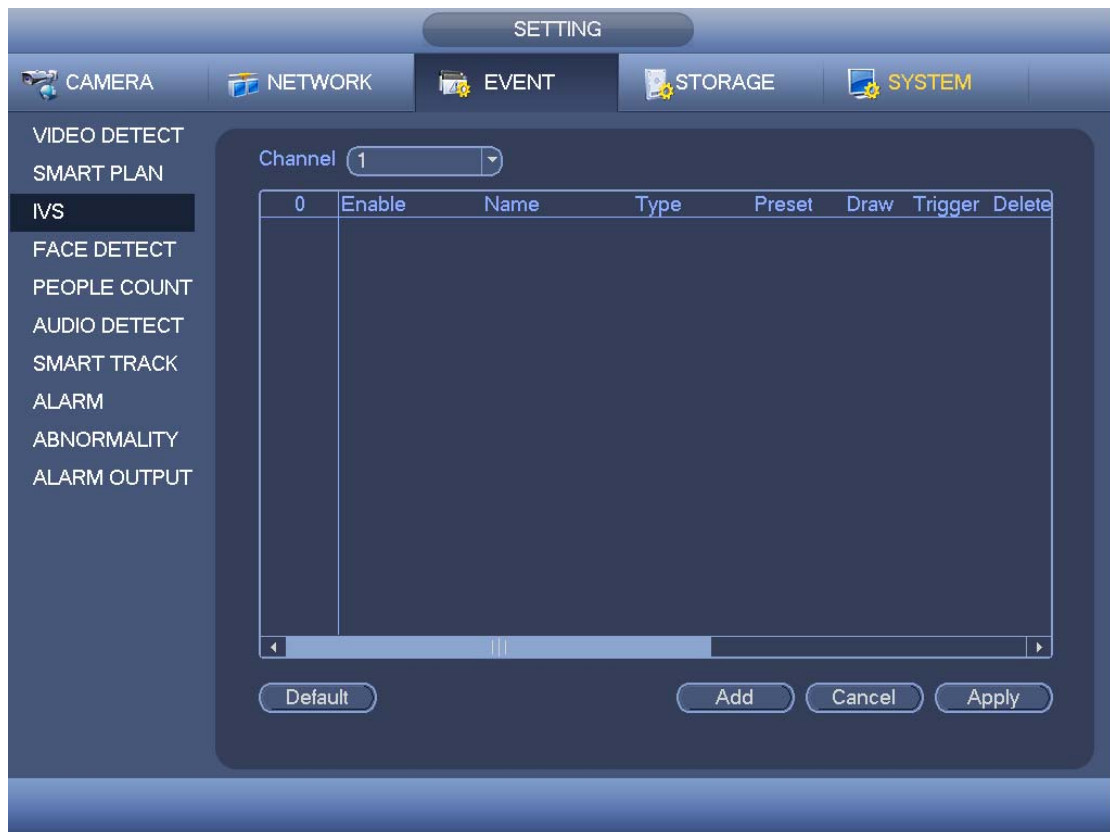

Figure 4-144

Select a channel from the dropdown list.

Click Add button to add a rule and then select a rule type from the dropdown list.

Set corresponding parameters.

Check the box to enable current rule.

Click Apply button to complete the setup.

4.15.3.1 Tripwire (Optional)

System generates an alarm once there is any object crossing the tripwire in the specified direction.

- The tripwire supports customized setup. It can be a straight line or a curve.
- Support one-direction or dual-direction detection.
- Support several tripwires at the same scene suitable for complicated environment.
- Support object size filter.

From main menu->Setting->Event->IVS, click Add button to add a rule and select the rule type as tripwire. The interface is shown as below. See Figure 4-145.

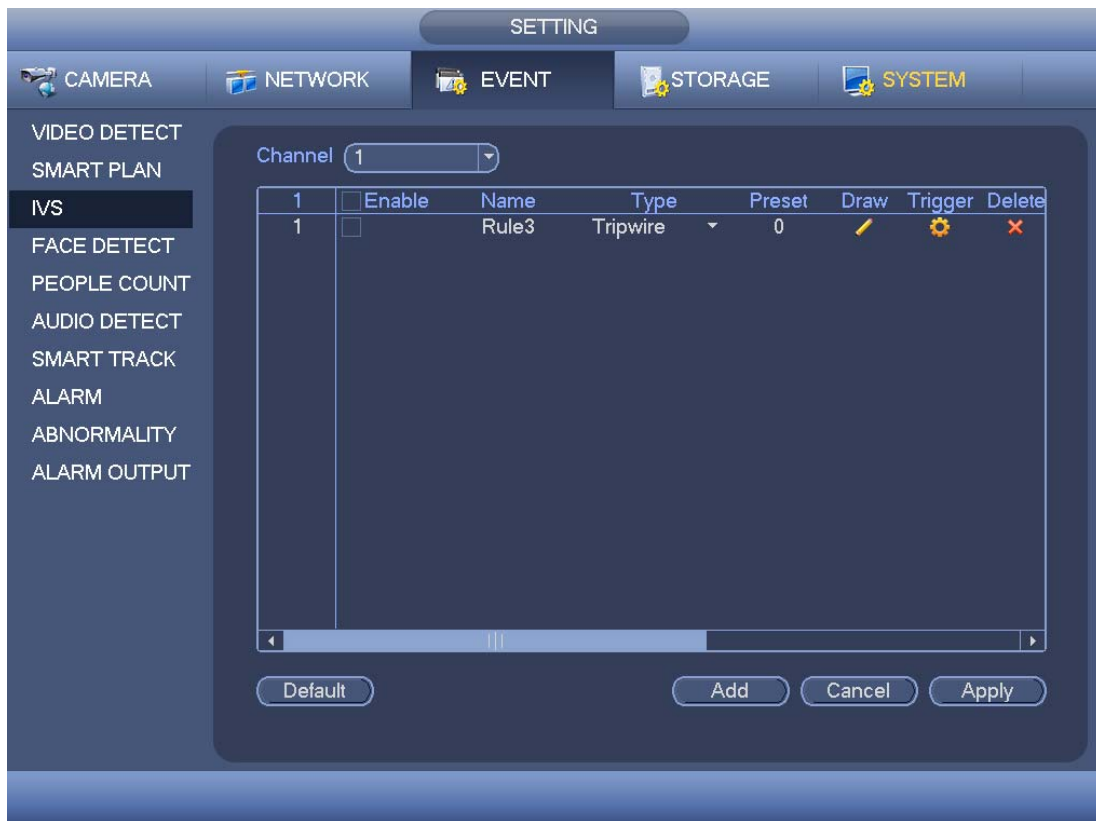

Figure 4-145



Click Draw button  to draw the tripwire. See Figure 4-146.



Figure 4-146

Select direction, and then input customized rule name.

- Name: Input customized rule name.
- Direction (L→R/R→L/Both): System can generate an alarm once there is any object crossing in the specified direction.
- Target filter: Click , you can set filter object size. Each rule can set two sizes (min size/max size). Once the object is smaller than the min size or larger than the max size, there is no alarm. Please make sure the max size is larger than the min size.

Now you can draw a rule. Left click mouse to draw a tripwire. The tripwire can be a direct line, curve or polygon. Right click mouse to complete.

Tips

Click  to delete the corresponding rule.

Click , you can see the following interface. See Figure 4-147.

You can refer to the following information to set other parameters.

- Period: Click set button, you can see an interface is shown as in Figure 4-136. Here you can set tripwire period. System only enables tripwire operation in the specified periods. There are two ways for you to set periods. Please note system only supports 6 periods in one day.

✧ In Figure 4-136, Select icon  of several dates, all checked items can be edited together. Now the icon is shown as . Click  to delete a record type from one period.

✧ In Figure 4-136. Click button  after one date or a holiday, you can see an interface shown as in Figure 4-137.

- Alarm output: when an alarm occurs, system enables peripheral alarm devices.
- Latch: when tripwire complete, system auto delays detecting for a specified time. The value ranges from 1-300(Unit: second)
- Show message: System can pop up a message to alarm you in the local host screen if you enabled this function.
- Send email: System can send out email to alert you when an alarm occurs.
- Record channel: System auto activates tripwire channel(s) to record once an alarm occurs. Please make sure you have set intelligent record in Schedule interface(Main Menu->Setting->Schedule) and schedule record in manual record interface(Main Menu->Advanced->Manual Record)
- PTZ activation: Here you can set PTZ movement when an alarm occurs. Such as go to preset, tour & pattern when there is an alarm. Click “set” button, you can see an interface is shown as in Figure 4-148.
- Record Delay: System can delay the record for specified time after alarm ended. The value ranges from 10s to 300s.

- Tour: Here you can enable tour function when an alarm occurs. Please go to main menu->Setting->System->Display->Tour to set tour type and interval (chapter 4.3.9)
- Snapshot: You can enable this function to snapshot image when a motion detect alarm occurs.
- Video matrix: Check the box here to enable this function. When an alarm occurs, VIDEO OUTPUT port displays device video output. It displays video (1-window tour) from alarm activation channel you select at the Record channel interface. It has high priority than the tour setup in Main menu->Setting->System->Video matrix. Please note this function is for some series product only.
- Buzzer: Highlight the icon to enable this function. The buzzer beeps when an alarm occurs.
- Log: Check the box here, system can record corresponding alarm log.
- Voice prompts: Check the box here to trigger audio broadcast function. You can select specified audio file here. System can play the audio file once the corresponding event occurs.



Figure 4-147

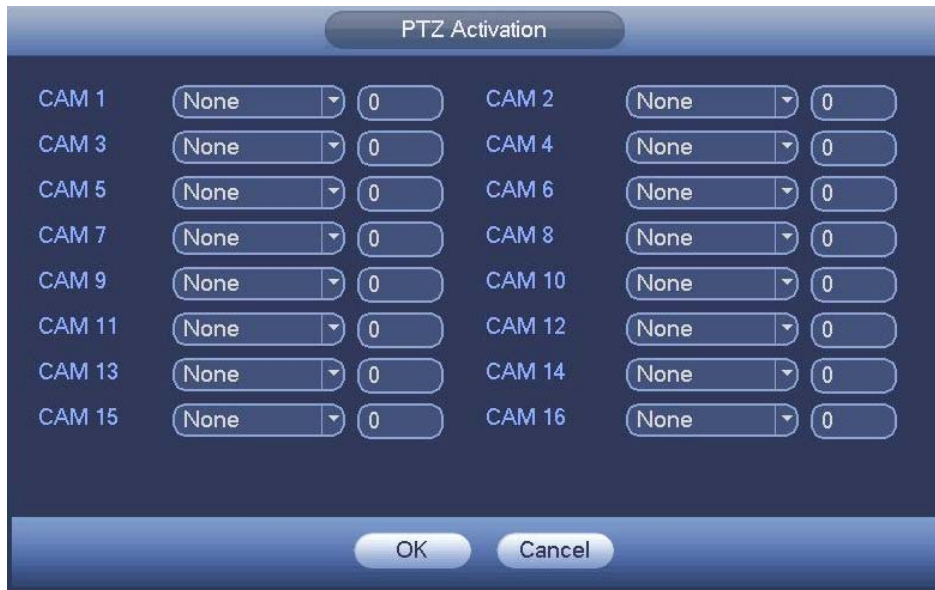

Figure 4-148

After you set the corresponding parameters, click OK button in Figure 4-147., and then click the Apply button in Figure 4-145 to complete the setup.

4.15.3.2 Intrusion (Cross warning zone) (Optional)

System generates an alarm once there is any object entering or exiting the zone in the specified direction.

From main menu->Setting->Event->IVS, click Add button and then select type as intrusion, the interface is shown as below. See Figure 4-149.

- System supports customized area shape and amount.
- Support appear/cross detection.
- Can detect the moving object operation in the specified zone, customized trigger amount and staying time.
- Support objects filter function.

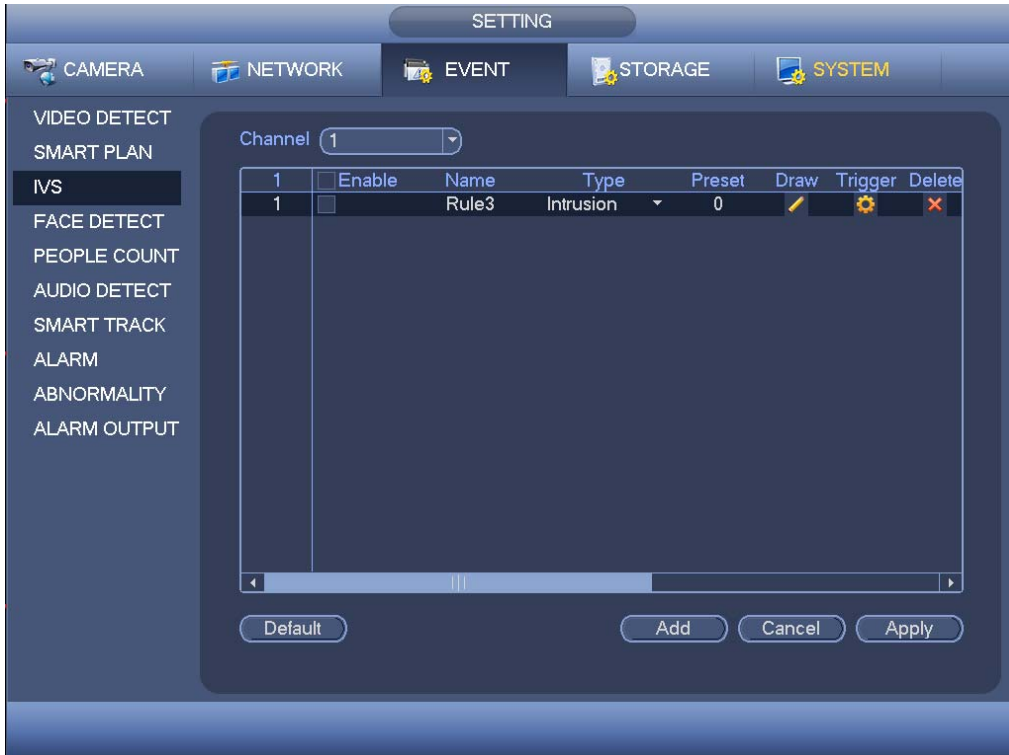



Figure 4-149

Click draw button  to draw the zone. See Figure 4-150.

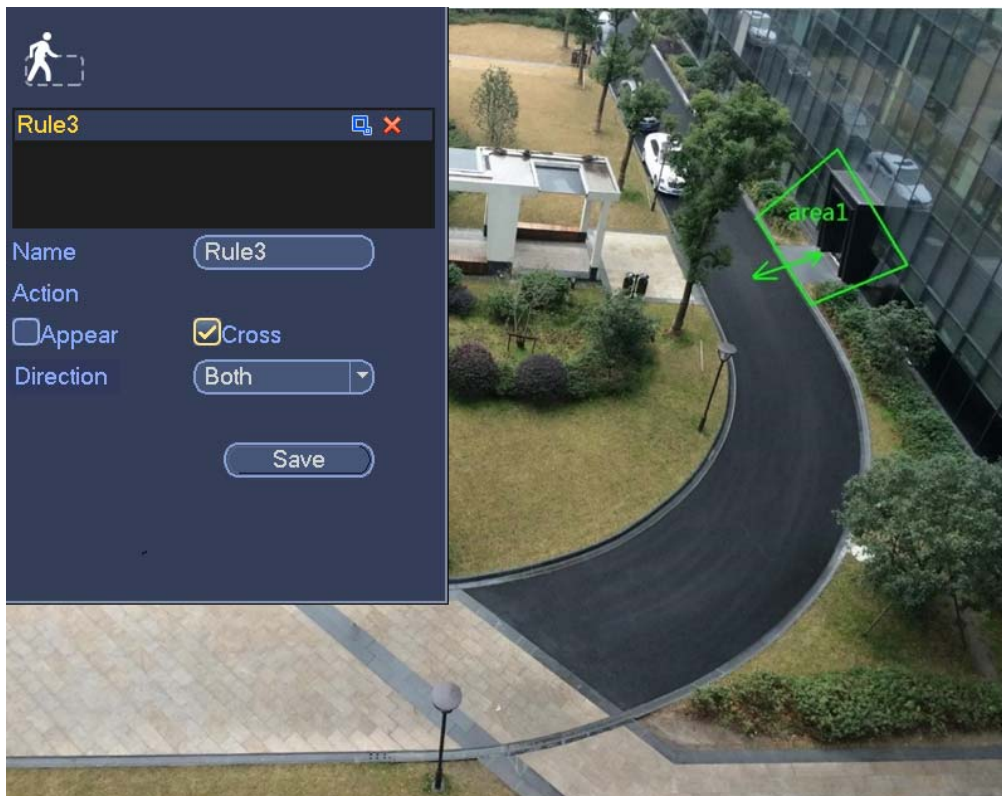



Figure 4-150

Select direction, and then input customized rule name.

- Name: Input customized rule name.
- Action: You can set intrusion action: appear/cross.
- Direction (Entry/Exit/Both): System can generate an alarm once there is any object crossing in the specified direction.
- Target filter: Click , you can set filter object size. Each rule can set two sizes (min size/max size). Once the object is smaller than the min size or larger than the max size, there is no alarm. Please make sure the max size is larger than the min size.

Now you can draw a rule. Left click mouse to draw a warning zone. Right click mouse to complete the setup.

Tips

Click  to delete the corresponding rule.

Click , you can refer to chapter 4.15.3.1 to set other parameters.

Click Apply to complete the setup.

4.15.3.3 Abandoned Object Detect (Optional)

System generates an alarm when there is abandoned object in the specified zone.

From main menu->Setting->Event->IVS, click Add button and then select the type as abandoned object. The object interface is shown as below. See Figure 4-151.

- System supports customized area shape and amount.
- Support duration setup.
- Support objects filter function.

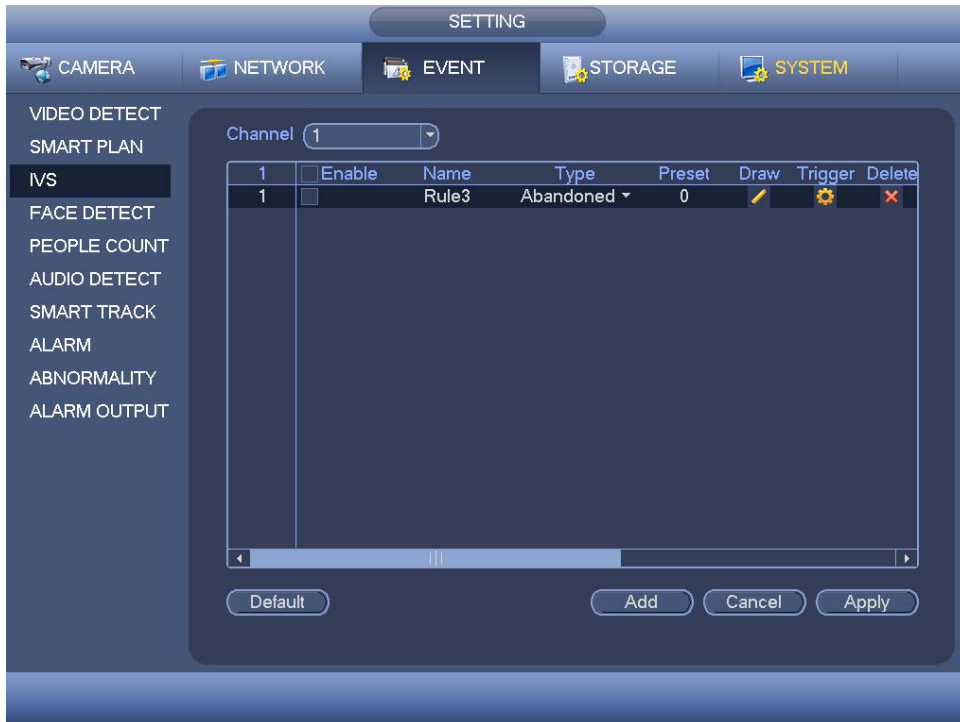

Figure 4-151

Click draw button  to draw the zone. See Figure 4-152.

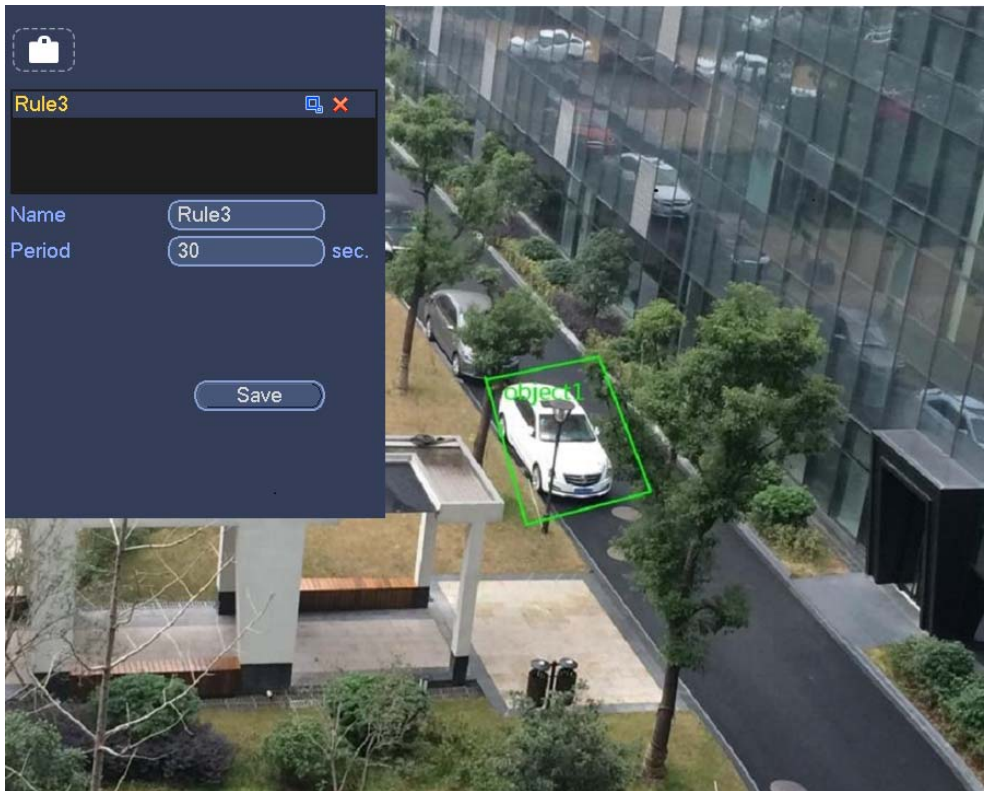



Figure 4-152

- Name: Input customized rule name.
 - Period: System can generate an alarm once the object is in the zone for the specified period.
 - Target filter: Click , you can set filter object size. Each rule can set two sizes (min size/max size). Once the object is smaller than the min size or larger than the max size, there is no alarm. Please make sure the max size is larger than the min size.
- Now you can draw a rule. Left click mouse to draw a zone, until you draw a rectangle, you can right click mouse.

Tips

Click  to delete the corresponding rule.

Click , you can refer to the chapter 4.15.3.1 to set other parameters.

Click Apply to complete the setup.

4.15.3.4 Missing Object Detection (Optional)

System generates an alarm when there is missing object in the specified zone.

From main menu->Setting->Event->IVS, select the type as abandoned object, the object interface is shown as below. See Figure 4-153.

- System supports customized area shape and amount.

- Support duration setup.
- Support objects filter function.

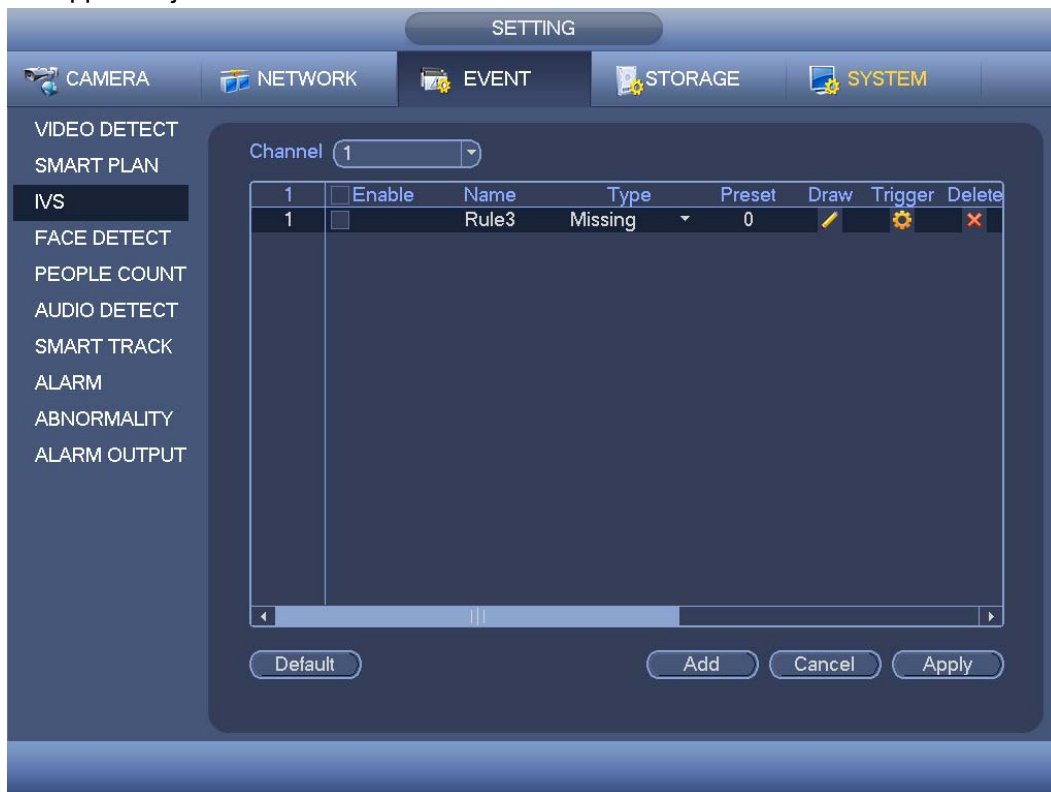

Figure 4-153



Click Draw button  to draw a zone. See Figure 4-154.



Figure 4-154

- Name: Input customized rule name.
- Period: System can generate an alarm once the object in the zone is missing for the specified period.
- Target filter: Click , you can set filter object size. Each rule can set two sizes (min size/max size). Once the object is smaller than the min size or larger than the max size, there is no alarm. Please make sure the max size is larger than the min size.

Now you can draw a rule. Left click mouse to draw a zone, until you draw a rectangle, you can right click mouse.

Tips

Click  to delete the corresponding rule.

Click , you can refer to the chapter 4.15.3.1 to set other parameters.

Click Apply to complete the setup.

4.15.4 Face Detection (Optional)

Important

- Please connect to a smart network camera if you want to use face detection function.
- Please make sure the connected smart network camera supports face detection function.

This function is to detect whether there is any human face in the detection zone. Once

there is a human face in the detection zone, system can use a rectangle to highlight human face in the preview window.

From main menu->Setting->Event->Face detect, the interface is shown as in Figure 4-155.

- Enable: Check the box to enable face detection function.
- Face ROI (Region of Interest): Check the box here, system can enhance the human face display pane. Please make sure you connected camera supports this function. Otherwise the checkbox is grey.
- Log: Check the box here, system can record face detection log.

You can refer to the chapter 4.15.1.1.1 motion detection to set other parameters.

Click OK to complete the setup.

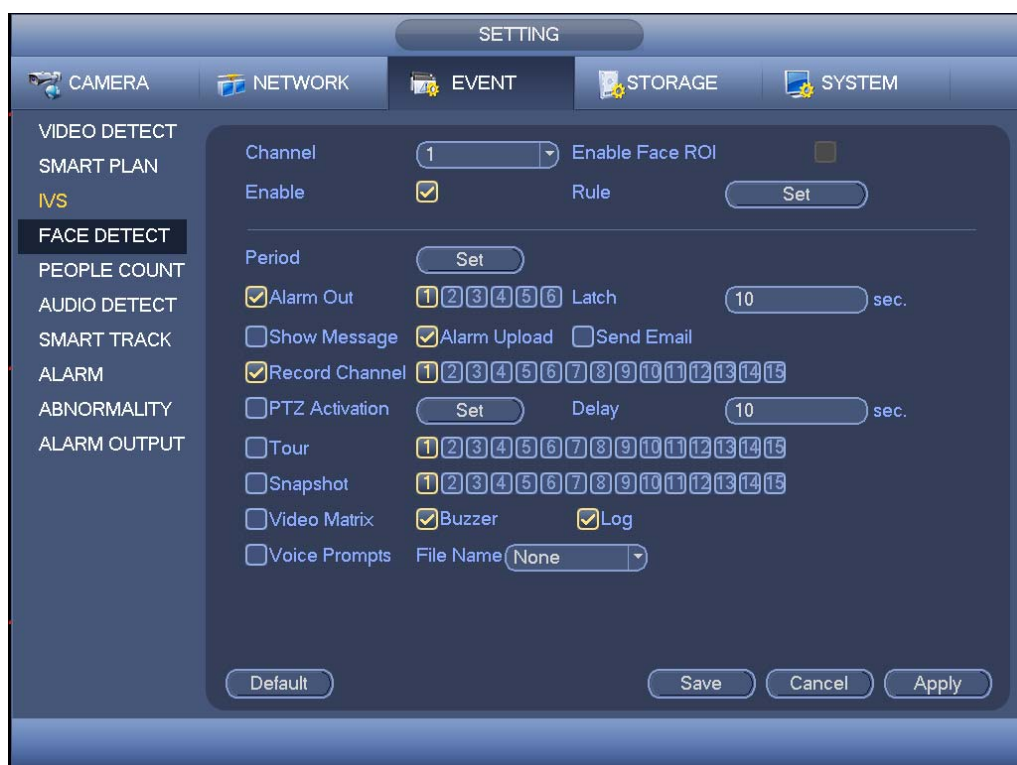

Figure 4-155

4.15.5 People Counting (Optional)

System can calculate the entry/exit people amount in the specified zone. It can generate an alarm when the amount has exceeded the threshold.

From main menu->Setting->Event->People counting, you can see an interface shown as in Figure 4-156.

- Enable: Check the box to enable people counting function.
- OSD overlay: Check the box here; you can view the people amount on the surveillance video.
- Rule setup: Click Set button, you can set people counting zone, name, and direction (entry/exit).
- Entry No.: It is to set people entry amount. System can generate an alarm once the

amount has exceeded the threshold.

- Exit No.: It is to set people exit amount. System can generate an alarm once the amount has exceeded the threshold.
- Remaining No.: It is to set people staying amount in the zone. System can generate an alarm once the amount has exceeded the threshold.

You can refer to the chapter 4.15.1.1.1 motion detection to set other parameters.

Click OK to complete the setup.



Figure 4-156

After you set the people counting function, from main menu->Info->Event->People counting, you can view people counting statistics report. Please refer to chapter 4.21.2.2 for detailed information.

4.15.6 Audio Detect

Important

- Please connect to a smart network camera if you want to use audio detection function.
- Please make sure the connected smart network camera supports audio detection function.

System can generate an alarm once it detect the audio input is abnormal or audio volume changes.

From main menu->Setting->Event->Audio detect, you can see an interface shown as in Figure 4-157.

- Input abnormal: Check the box here, system can generate an alarm once the audio input is abnormal.
- Intensity change: Check the box here, system can generate an alarm once the audio volume becomes strong.
- Sensitivity: It refers to the audio recognition sensitivity. The higher the value is, the higher the sensitivity is.
- Threshold: It is to set intensity change threshold. The smaller the value is, the higher the sensitivity is.
- Log: Check the box here, system can record audio detect alarm log.

You can refer to the chapter 4.15.1.1.1 motion detection to set other parameters.



Figure 4-157

4.15.7 Smart Track (Optional)

Important

- The fisheye and the PTZ camera shall surveillance proper zone.
- The fisheye and the PTZ camera shall use the private protocol to add.

The smart track function refers to a system consisting of the fisheye and the PTZ camera. The fisheye is the master camera to view the whole surveillance situation, and the PTZ camera is the slave camera to view the details.

From Main menu->Setting->Event->Smart track, you can see an interface shown as Figure 4-158.

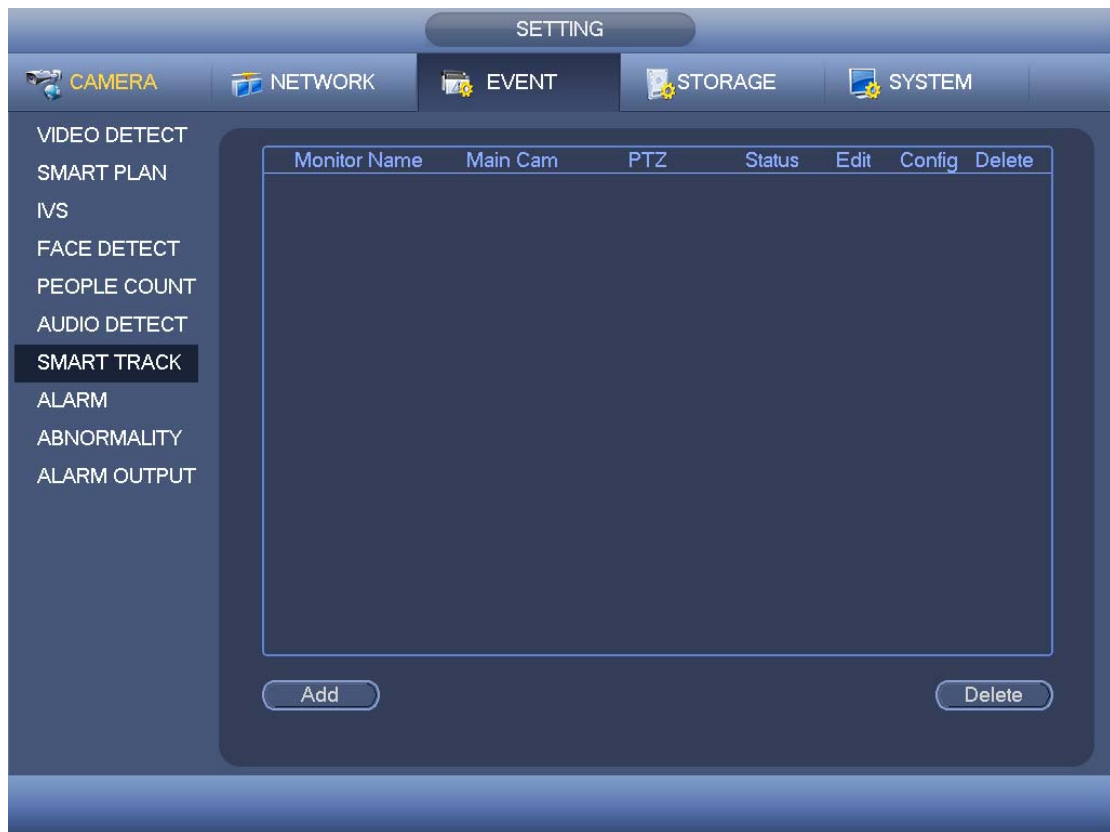

Figure 4-158

Click add button, you can see an interface shown as in Figure 4-159.

- Type: Here you can select smart track mode. It includes: 1 fisheye+1 PTZ camera/1 fisheye+2 PTZ cameras/1 fisheye+3 PTZ cameras.
- Monitor name: It is the monitor position. Input customized monitor position name.
- Main channel: Click Select button and then select fisheye from the dialogue box. Click Ok button, you can view the channel number and channel name.
- PTZ camera: Click Select button and then select corresponding PTZ camera amount from the dialogue box. Click Ok button, you can view PTZ camera channel number, channel name and IP address.



Figure 4-159

After the setup, click OK button.

In Figure 4-158, click  or double click the monitor line you just added, you can go to the following interface. See Figure 4-160. Here you can set the fisheye and PTZ camera bonding relationship.

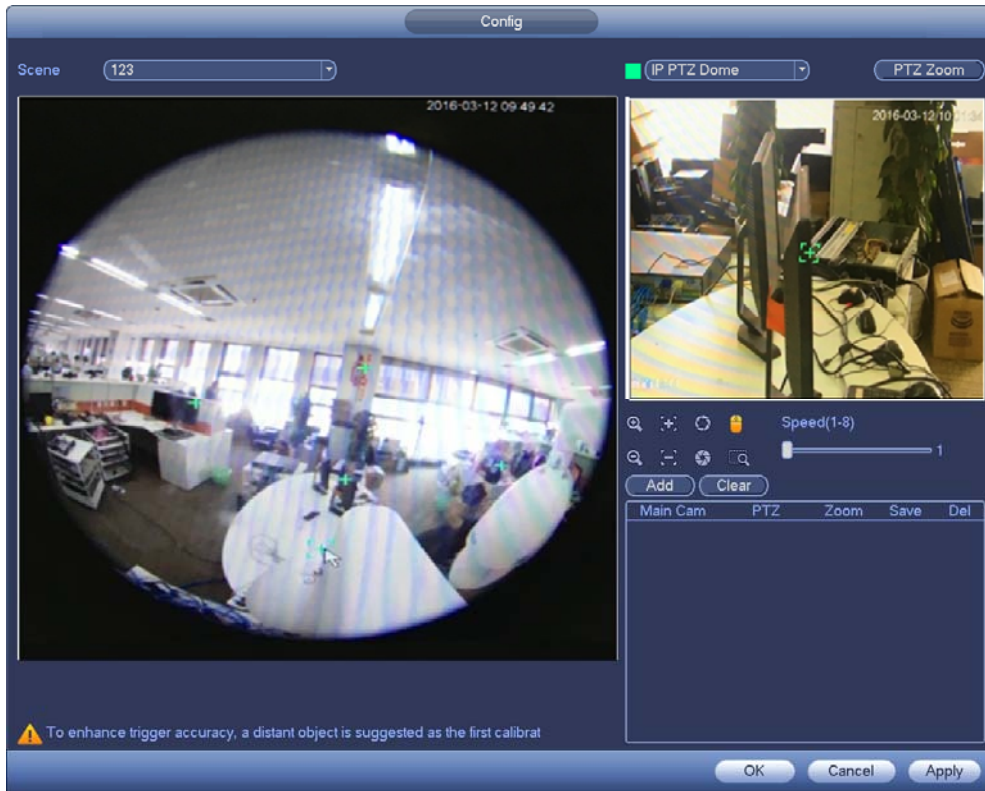









Figure 4-160

On the fisheye displayed zone, left click mouse or move  to confirm the position.

On the PTZ camera displayed zone, use the following buttons to adjust the PTZ camera position.

Button	Function
	Zoom
	Focus
	Iris
	Electronic mouse, move it on the interface to control the PTZ direction.
	Fast positioning button. Click it first and then click any position in the video. Left click mouse, you can view the video from the specified position.
	It is to control PTZ movement speed. The higher the value is, the faster the speed is. For example, the step 8 speed is faster than step 1.

Click add button and then click  to save.

Now you complete one group position, you can view at the list. See Figure 4-161.

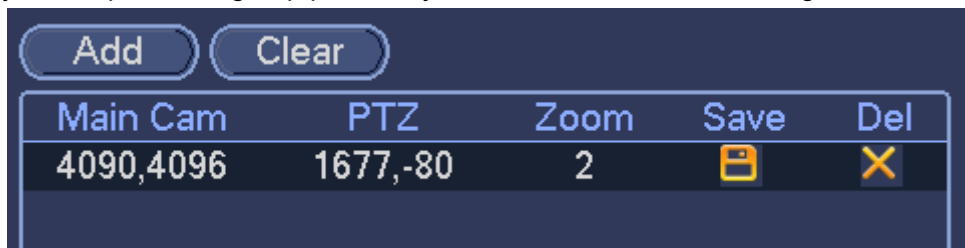



Figure 4-161

Repeat the above steps to set at least three group positions.

Note

- For one PTZ camera, there must be four calibration groups. System max supports 8 group positions. Please make sure the calibration position is accurate.
- For the first calibration group position, please select the reference objects at the far distance to enhance the trigger accuracy.

Click OK button to complete the calibration setup, you can go back to the smart track

interface, the status is shown as .

Note

After you complete smart track setup, please go to the preview interface and then right click mouse, and then select Smart track, you can view the corresponding video. Please refer to chapter 4.15.7 for detailed information.

4.15.8 Alarm Settings

Before operation, please make sure you have properly connected alarm devices such as buzzer.

In the main menu, from Setting->Event->Alarm, you can see alarm setup interface.

4.15.8.1 Local alarm

Local alarm refers to the alarm signal system detects from the alarm input port.

In the main menu, from Setting->Event->Alarm->Local, the interface is shown as in Figure 4-162.

- Alarm in: Here is for you to select channel number.
- Type: normal open or normal close.
- PTZ activation: Here you can set PTZ movement when alarm occurs. Such as go to preset, tour & pattern when there is an alarm. Click "select" button, you can see an interface is shown as in Figure 4-163.
- Period: Click set button, you can see an interface is shown as in Figure 4-164. There are two ways for you to set periods. There are max 6 periods in one day. There are four record types: regular, motion detection (MD), Alarm, MD & alarm.

✧ In Figure 4-164, Select icon  of several dates, all checked items can be edited together. Now the icon is shown as . Click  to delete a record type from one period.

✧ In Figure 4-164. Click button  after one date or a holiday, you can see an interface shown as in Figure 4-165. There are four record types: regular, motion detection (MD), Alarm, MD & alarm.

- Anti-dither: Here you can set anti-dither time. Here you can set anti-dither time. The value ranges from 5 to 600s. The anti-dither time refers to the alarm signal lasts time. It can be seen as the alarm signal activation stays such as the buzzer, tour, PTZ activation, snapshot, channel record. The stay time here does not include the latch time. During the alarm process, the alarm signal can begin an anti-dither time if system detects the local alarm again. The screen prompt, alarm upload, email and etc will not be activated. For example, if you set the anti-dither time as 10 second, you can see the each activation may last 10s if the local alarm is activated. During the process, if system detects another local alarm signal at the fifth second, the buzzer, tour, PTZ activation, snapshot, record channel will begin another 10s while the screen prompt, alarm upload, email will not be activated again. After 10s, if system detects another alarm signal, it can generate an alarm since the anti-dither time is out.
- Show message: System can pop up a message to alarm you in the local host screen if you enabled this function.
- Alarm upload: System can upload the alarm signal to the network (including alarm center) if you enabled current function.
- Send email: System can send out email to alert you when alarm occurs.
- Record channel: you can select proper channel to record alarm video (Multiple choices). At the same time you need to set alarm record in schedule interface (Main Menu->Setting->Schedule) and select schedule record in manual record interface (Main Menu->Advance->Manual Record).
- Latch: Here is for you to set proper delay duration. Value ranges from 10 to 300 seconds. System automatically delays specified seconds in turning off alarm and activated output after external alarm cancelled.
- Tour: Here you can enable tour function when alarm occurs. System supports 1/8-window tour. Please note the tour setup here has higher priority than the tour setup you set in the Display interface. Once there two tours are both enabled, system can enable the alarm tour as you set here when an alarm occurred. If there is no alarm, system implements the tour setup in the Display interface.
- Snapshot: System can snapshot corresponding channel when an alarm occurs. Please note the activation snapshot has the higher priority than schedule snapshot. If you have enabled these two types at the same time, system can activate the activation snapshot when alarm occurs, and otherwise system just operates the schedule snapshot.
- Video matrix: Check the box here to enable this function. When an alarm occurs,

VIDEO OUTPUT port displays device video output. It displays video (1-window tour) from alarm activation channel you select at the Record channel interface. It has high priority than the tour setup in Main menu->Setting->System->Video matrix. Please note this function is for some series product only.

- Log: Check the box here, system can record local alarm log.
- Buzzer: Highlight the icon to enable this function. The buzzer beeps when alarm occurs.
- Voice prompts: Check the box here to trigger audio broadcast function. You can select specified audio file here. System can play the audio file once the corresponding event occurs.

Please note, network alarm means the alarm signal from the TCP/IP. You can use NET SDK to activate network alarm. Comparing with the local alarm, there is no type, anti-dither, alarm upload function.

Please highlight icon  to select the corresponding function. After setting all the setups please click save button.



Figure 4-162

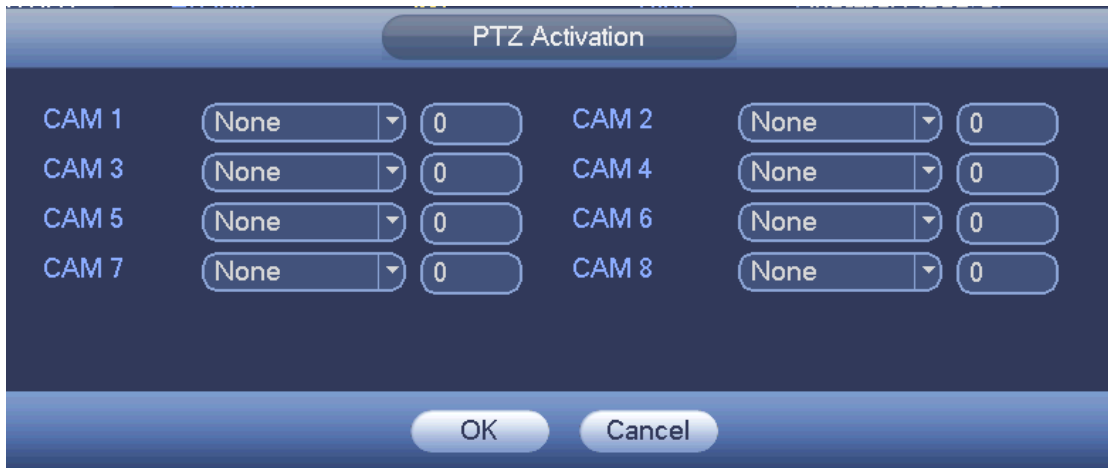

Figure 4-163

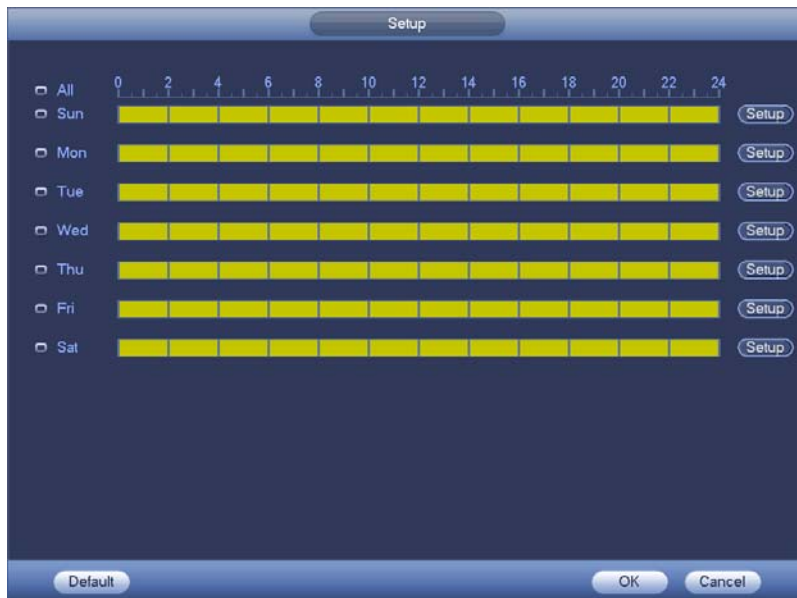

Figure 4-164



Figure 4-165

4.15.8.2 Network Alarm

Network alarm refers to the alarm signal from the network.

In the main menu, from Setting->Event->Alarm->Net, you can see the following interface .See Figure 4-166.

Please refer to chapter 4.15.8.1 to set parameters and then click OK button to save current setup.

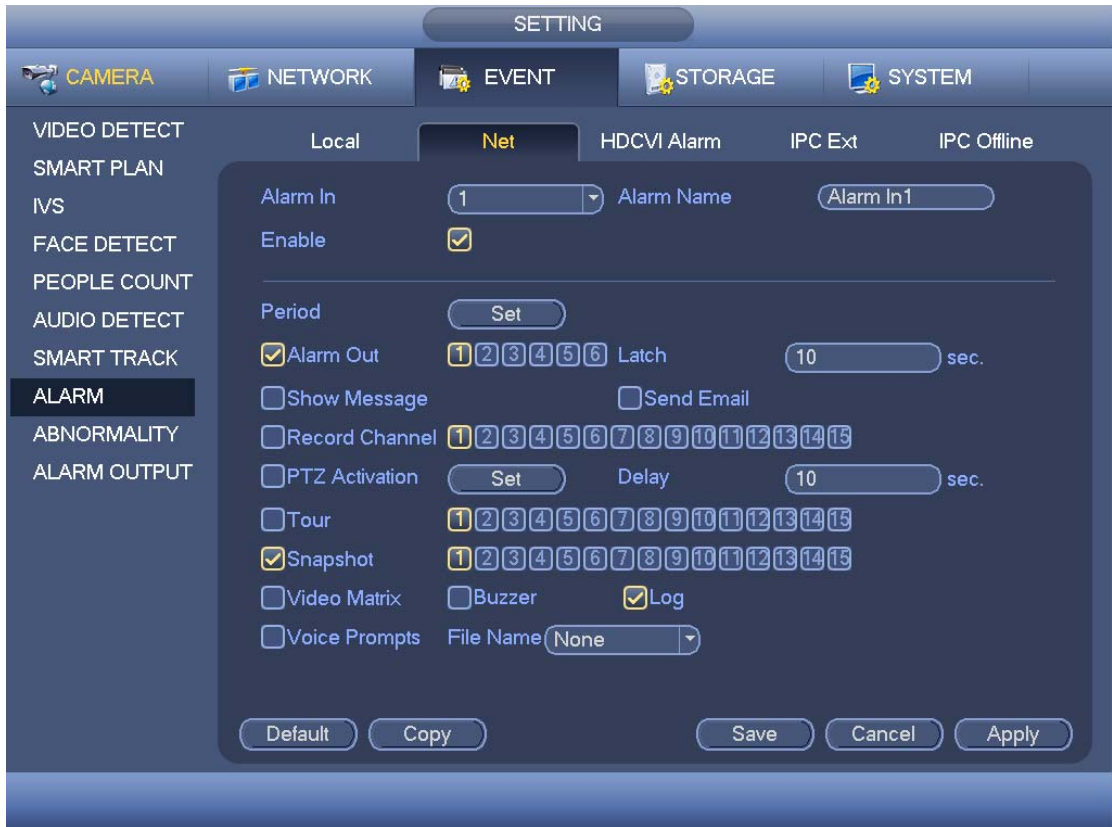

Figure 4-166

4.15.8.3 HD AVS Alarm

System can get the camera temperature, smoke, external alarm and set corresponding alarm activation operation. This function is null if the camera does not support the alarm function.

In the main menu, from Setting->Event->Alarm->HD AVS, the HD AVS alarm interface is shown as in Figure 4-167.

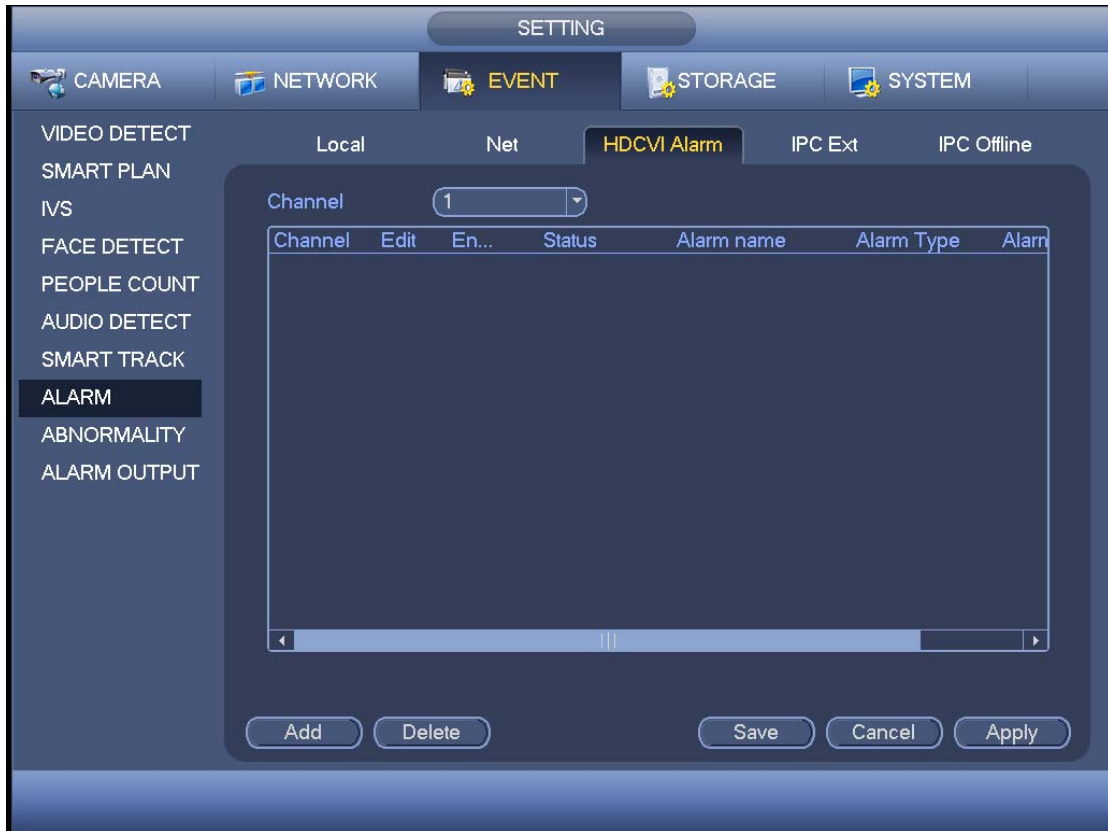



Figure 4-167

In Figure 4-167., click Add button, you can go to the following interface. See Figure 4-168.

Check the box you want to add. The displayed alarm input channel amount here depends on the camera amount.



Figure 4-168

Click Add button, system goes back to Figure 4-167. Check , you can set alarm parameters. Please refer to chapter 4.15.8.1 for detailed information. Check the box to enable HD AVS alarm function and then click OK button to save current setup.

4.15.8.4 IPC External Alarm

IPC external alarm is the on-off alarm signal from the front-end device and can activate the local HDVR.

In the main menu, from Setting->Event->Alarm->IPC external, the interface is shown as in Figure 4-169.

Please refer to chapter 4.15.8.1 to set parameters and then click OK button to save current setup.



Figure 4-169

4.15.8.5 IPC Offline Alarm

Once you select this item, system can generate an alarm when the front-end IPC disconnects with the local DVR. The alarm can activate record, PTZ, snap and etc. The alarm can last until the IPC and the HDVR connection resumes.

In the main menu, from Setting->Event->Alarm->IPC offline, the interface is shown as below. See Figure 4-170.

Please refer to chapter 4.15.8.1 to set parameters and then click OK button to save current setup.



Figure 4-170

4.15.9 Abnormality

In the main menu, from Setting->Event->Abnormality, the interface is shown as below.

- There are four types: HDD/Network/User/Device.
 - ✧ HDD: HDD error, no disk, no space. See Figure 4-171 and Figure 4-172.
 - ✧ Network: Disconnection, IP conflict, MAC conflict. See Figure 4-173.
 - ✧ User:Illegal login. See Figure 4-174 .
 - ✧ Device:Device temperature is too high or fan speed is abnormal. See Figure 4-175.
- Alarm output: Please select alarm activation output port (multiple choices).
- Less than: System can alarm you when the HDD space is less than the threshold you set here. This item is for disk no space type only.
- Max temperature: You can set max temperature value here. The device can generate an alarm once the device temperature is higher than the threshold you set. This item is for high temperature type only.
- Latch: Here you can set corresponding delaying time. The value ranges from 1s-300s. System automatically delays specified seconds in turning off alarm and activated output after external alarm cancelled.
- Show message: system can pop up the message in the local screen to alert you when an alarm occurs.
- Alarm upload: System can upload the alarm signal to the network (including alarm center) if you enabled current function. For disconnection event, IP conflict event and MAC conflict event, this function is null.

- Send email: System can send out email to alert you when alarm occurs.
- Buzzer: Highlight the icon to enable this function. The buzzer beeps when alarm occurs.
- Log: Check the box here, system can record HDD event log.
- Voice prompts: Check the box here to trigger audio broadcast function. You can select specified audio file here. System can play the audio file once the corresponding event occurs.



Figure 4-171

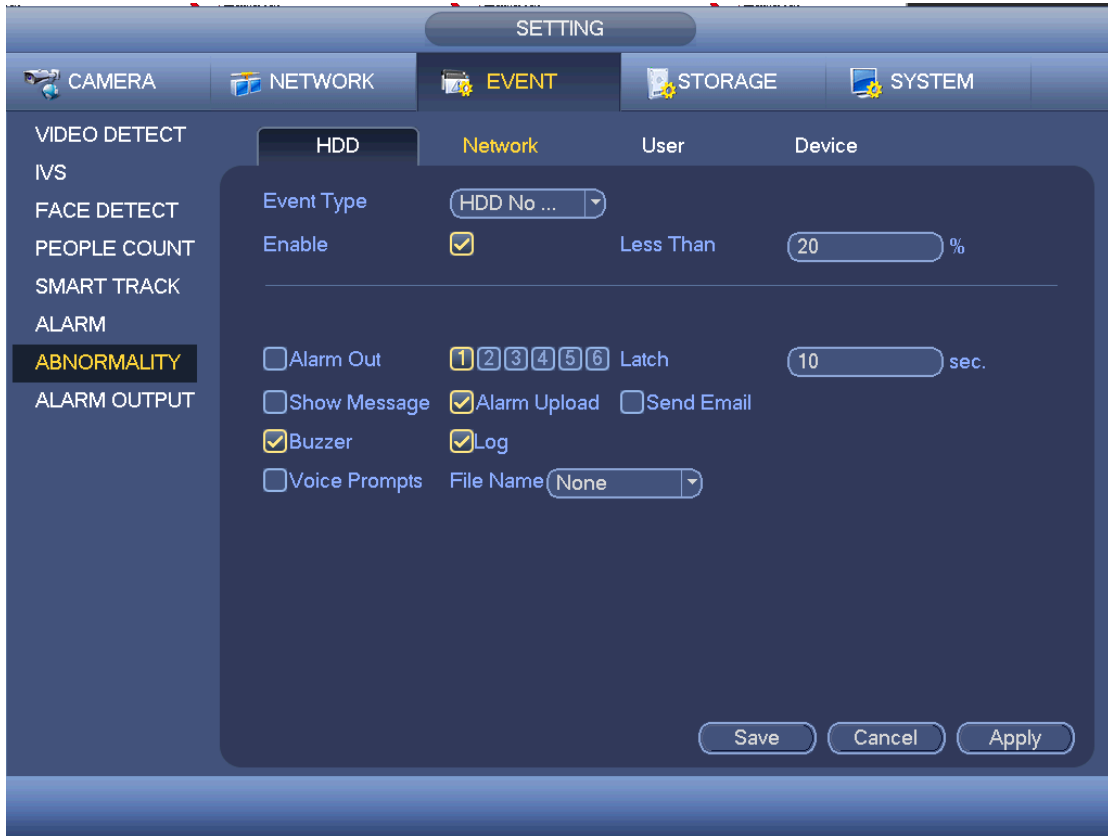

Figure 4-172

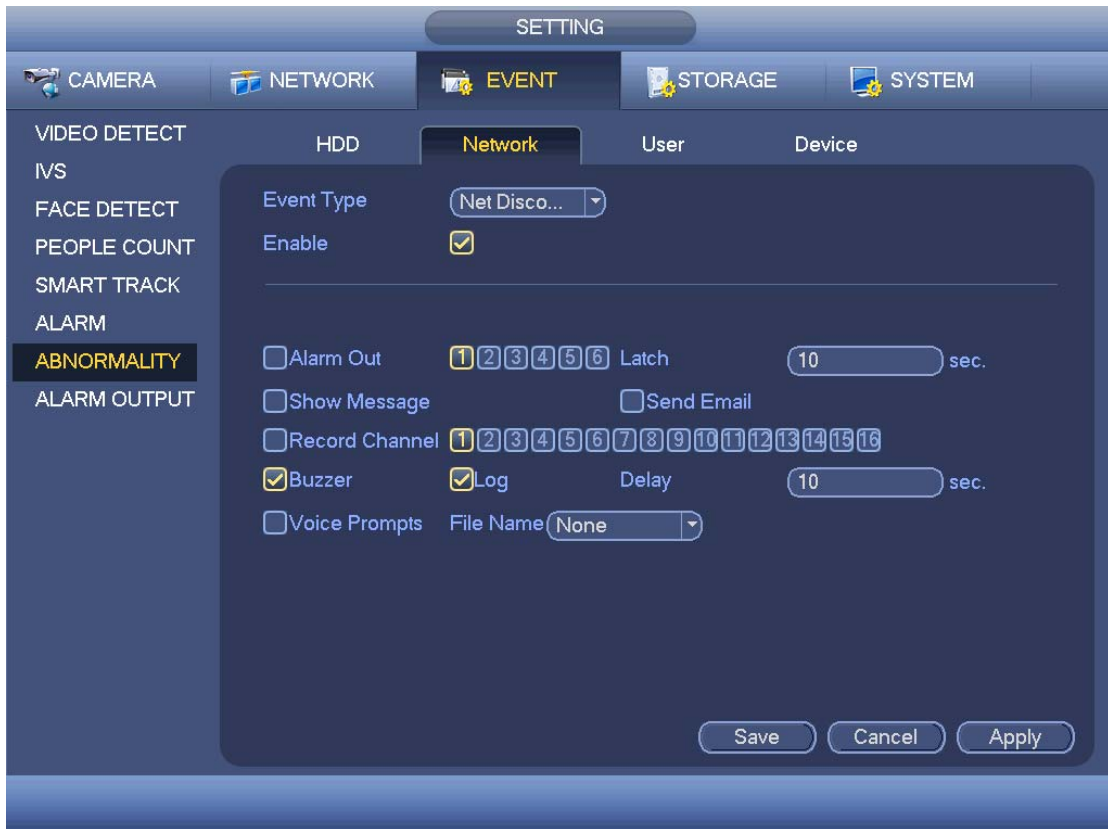

Figure 4-173



Figure 4-174

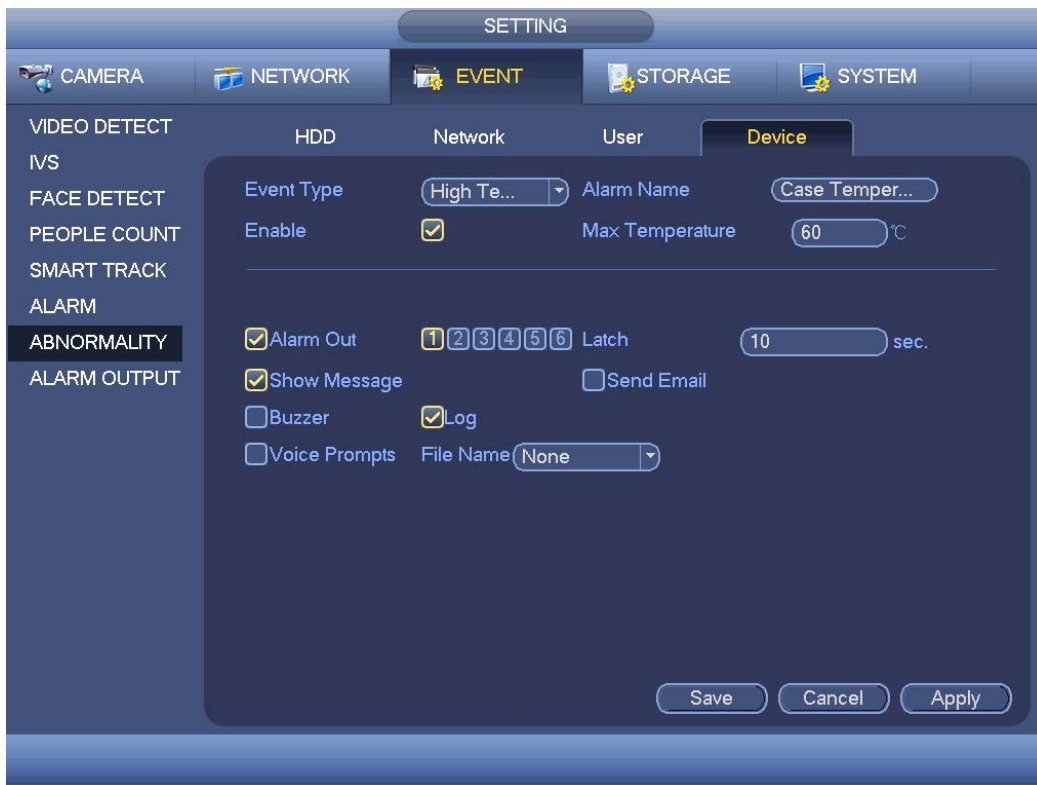

Figure 4-175

4.15.10 Alarm Output

In the main menu, from Setting->Event->Alarm output, the interface is shown as below. Here is for you to set proper alarm output. See Figure 4-176.

- Auto: The corresponding event triggers the alarm output or cancels alarm.
- Manual: Forcedly trigger alarm output.
- Stop: Forcedly cancel or close alarm output.
- Status: Here you can view alarm output port status. The alarm is enabled if the icon is highlighted.
- Alarm release: Click the OK button, you can clear all alarm output status.

After you completed all the setups, please click Save button.



Figure 4-176

4.16 Storage

It is to manage HDD storage space, detect HDD working status and etc.

4.16.1 HDD Manager

From main menu->Setting->Storage->HDD manager, here is for you to view and implement hard disk management. See Figure 4-177.

You can see current HDD type, status, capacity and etc. The operation includes format HDD, and change HDD property (read and write/read-only/redundancy).

- To prevent files be overwritten in the future, you can set HDD as read-only.
- To backup recorded video file, you can set HDD as redundant HDD.

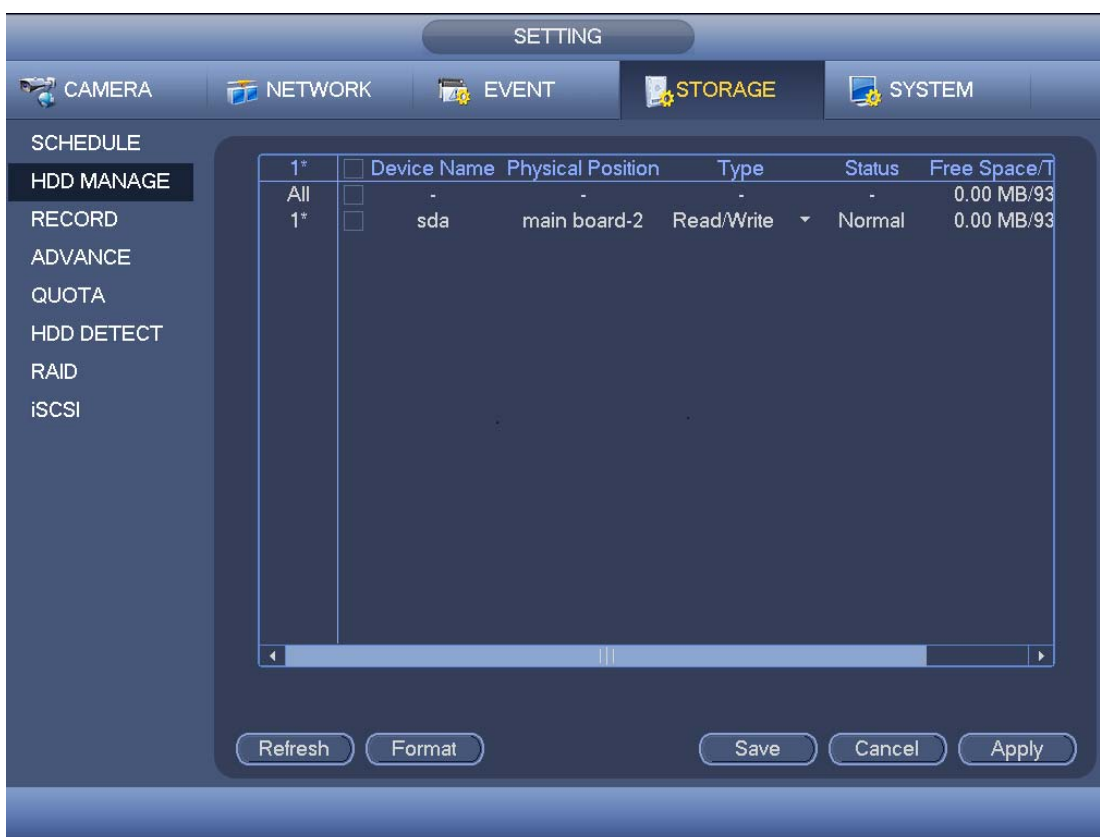

Figure 4-177

4.16.2 HDD Group

4.16.2.1 Advanced

It is to set HDD group, and HDD group setup for main stream, sub stream and snapshot operation

HDD

Important

HDD group and quota mode can not be valid at the same time. System needs to restart once you change the mode here.

From main menu->Setting->Storage->Advanced->HDD, you can see the following interface. See Figure 4-178.

- HDD: Here you can view the HDD amount the device can support.
- Group: It lists the HDD Group number of current hard disk.

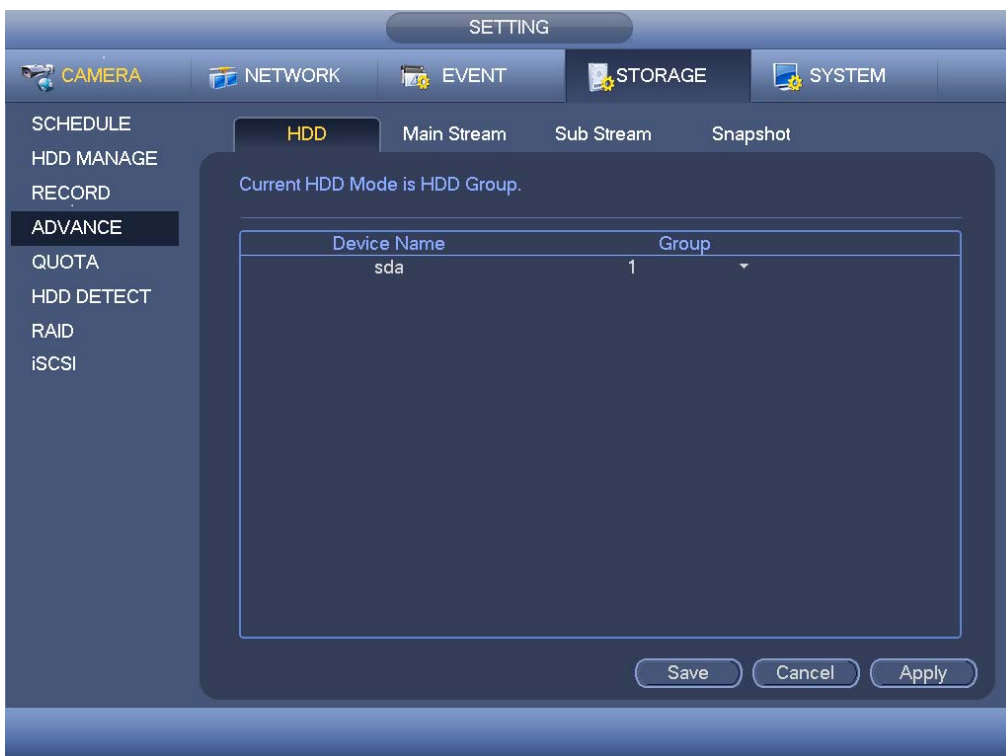

Figure 4-178

Please select the correspond group from the dropdown list and then click Apply button. Click main stream/sub stream/snapshot button to set corresponding HDD group information. See Figure 4-179.



Figure 4-179



Figure 4-180



Figure 4-181

4.16.3 Quota

Here you can set channel storage capacity.

From main menu->Setting->Storage->Quota, you can see the following interface. See Figure 4-182.

Select a channel from the dropdown list and then select corresponding HDD quota.



Figure 4-182

Click Statistics, you can go to the following interface. You can view HDD capacity you set for each channel. See Figure 4-183.



Figure 4-183

4.16.4 HDD Detect

The HDD detect function is to detect HDD current status so that you can clearly understand the HDD performance and replace the malfunction HDD.

There are two detect types:

- Quick detect: It is to detect the stored files on the HDD. You can use format function to repair the bad track. System can not detect the bad track if there is no record on the HDD.
- Global detect: It detects the whole HDD. The process may take a long time and may affect the HDD that is saving the record. If it detects the bad track, it may result from the damaged HDD.

4.16.4.1 Manual Detect

The manual detect interface is shown as below. See Figure 4-184.

Please select detect type and HDD. Click start detect to begin. You can view the corresponding detect information. See Figure 4-185.

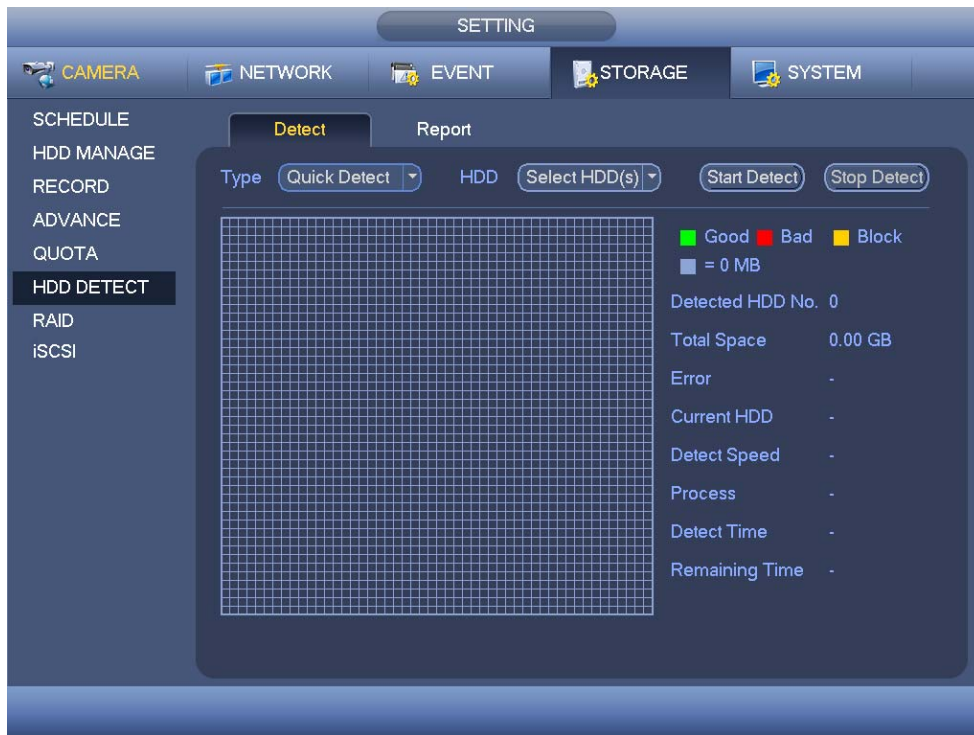

Figure 4-184

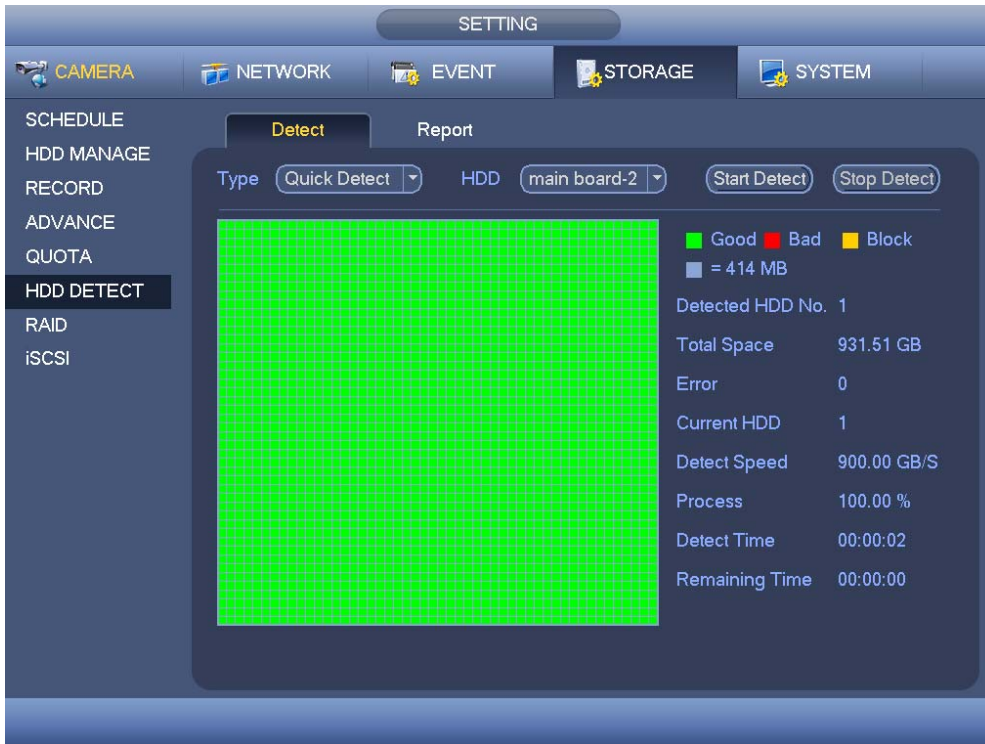

Figure 4-185

4.16.4.2 Detect Report

After the detection operation, you can go to the detect report to view corresponding information.

The detect report interface is shown as below. See Figure 4-186.

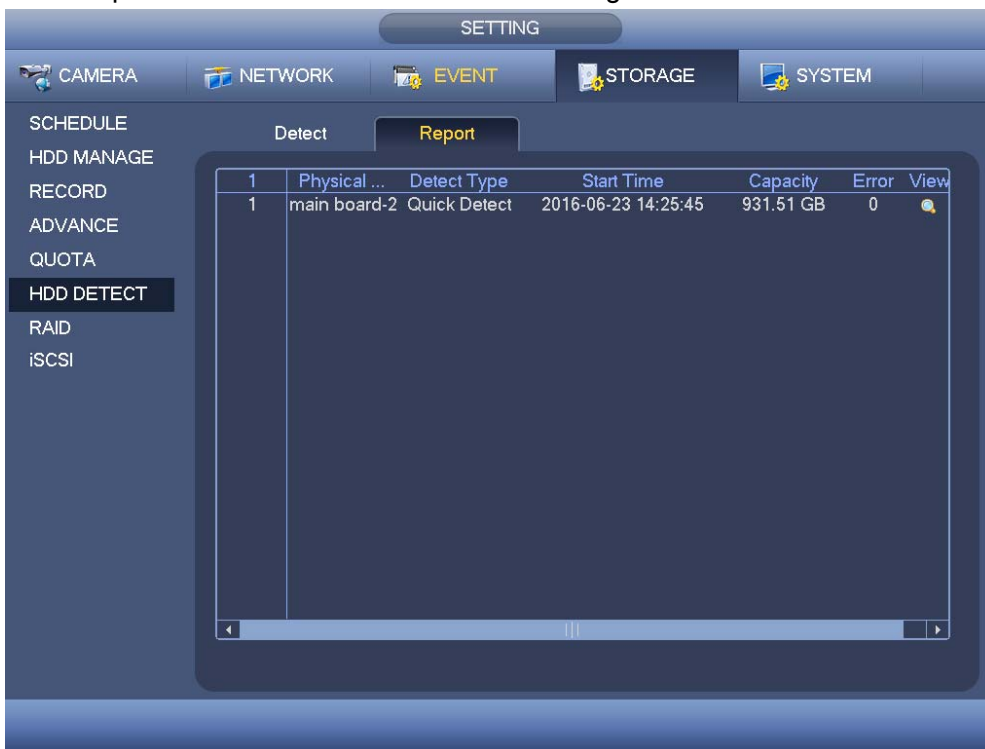

Figure 4-186

Click View, you can see the detailed information such as detect result, backup and S.M.A.R.T. See Figure 4-187 and Figure 4-188 .

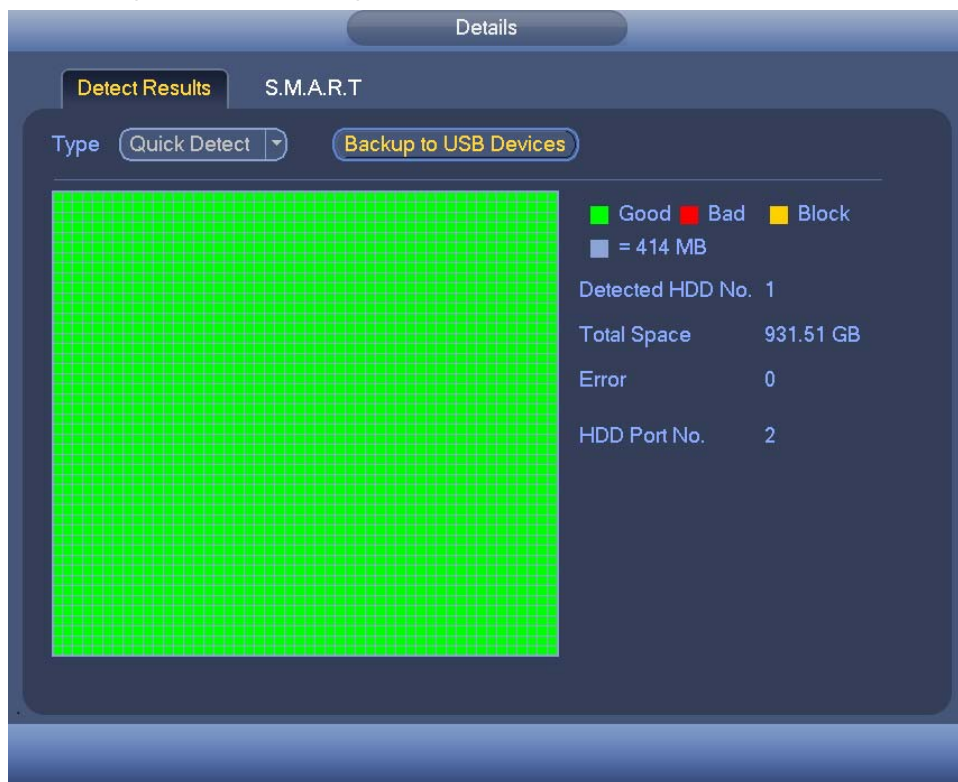

Figure 4-187



Figure 4-188

4.16.5 RAID

Note

RAID function is for some series product only.

The RAID (redundant array of independent disks) management can compost the independent HDDs together to provide larger space as the logic HDD. It can enhance system I/O performance, data usage and data security.

Right now system supports RAID0/RAID1/RAID5/RAID10.

RAID Type	HDD Amount
RAID0	At least 2 HDDs
RAID1	Only 2 HDDs
RAID5	At least 3 HDDs. Usually we recommend 4 to 6 HDDs.
RAID10	At least 4 HDDs. The amount shall be even number.

4.16.5.1 RAID Config

The RAID configuration interface is shown as in Figure 4-189. In this interface, you can set RAID type and settings.

- Create manually: It is to create RAID manually. Please select RAID type first and then follow the prompts to set HDD amount. Click Create Manually button, system pops up dialogue box to warning you it is going to clear all data. Click OK button to complete the operation.
- Create RAID: Click it to automatically create RAID5.

For create RAID function, you can select the physical HDD that does not included in the RAID group or the created disk array to create a RAID5. You can refer to the following situations:

- There is no RAID, no hotspare disk: System directly creates the RAID5 and creates one hotspare disk at the same time.
- There is no RAID, but there is a hotspare disk: System creates the RAID5 only. It uses previous hotspare disk.
- There is RAID: System cancel the previous RAID setup and then create the new RAID5. System creates the hotspare disk if there is no one. System uses previous hotspare disk if there is hotspare disk available.
- The background will format the virtual disk.

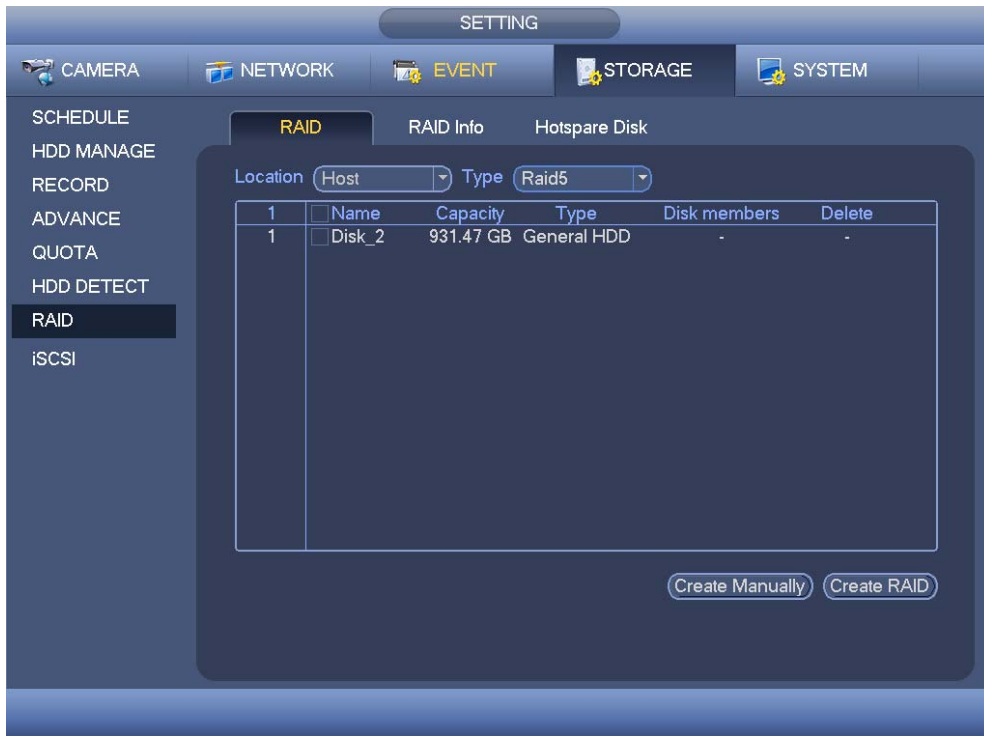

Figure 4-189

4.16.5.2 RAID Info

It is to display RAID name, space, type, member HDD, hotspare HDD, status and etc. Here you can delete RAID. See Figure 4-190.

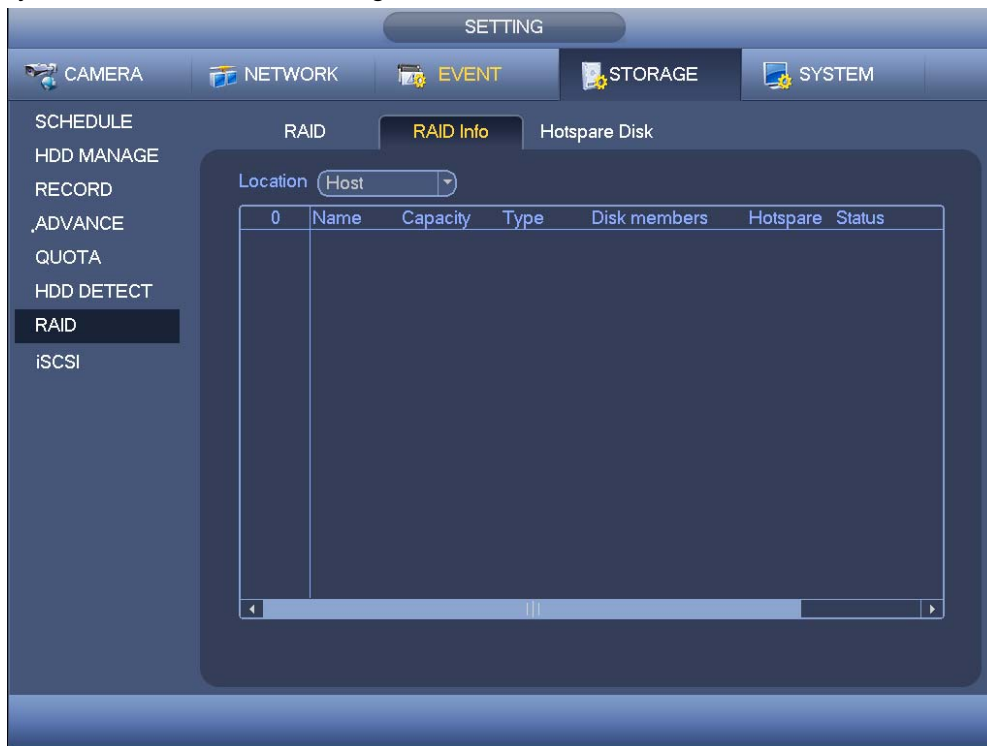

Figure 4-190

4.16.5.3 Hotspare Disk

In this interface you can add/delete hotspare HDD if you have set RAID. See Figure 4-191.

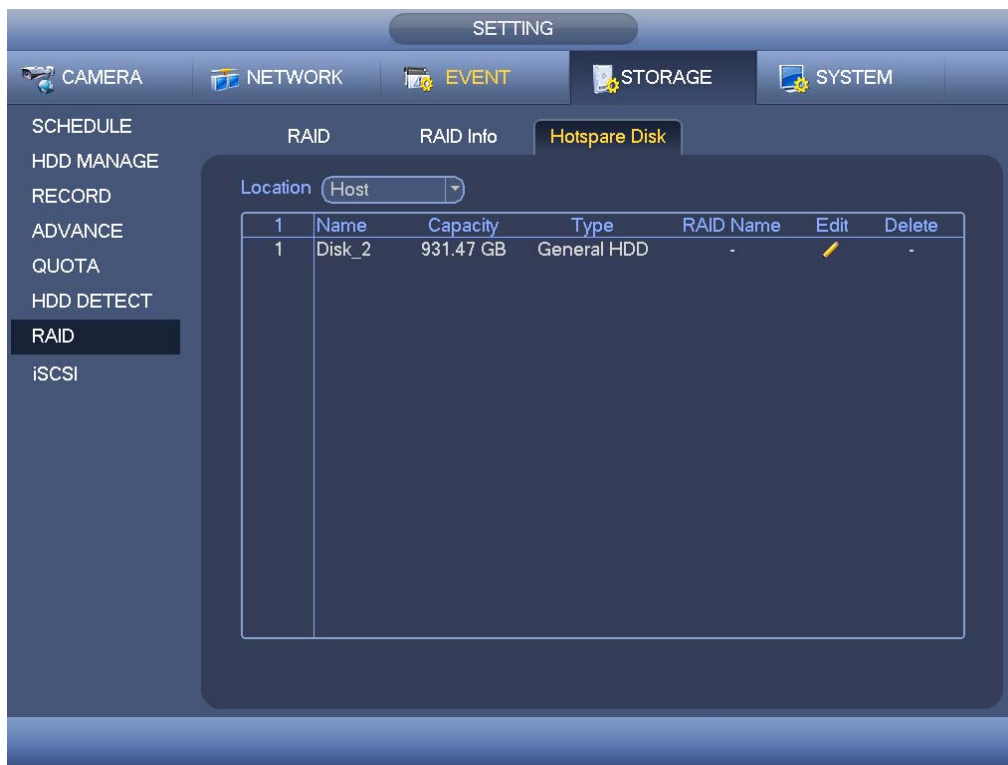

Figure 4-191

Click , you can set corresponding disk to the hotspare disk.

- Private hotspare: Please select the RAID disk to be added. It becomes the hotspare disk of the specified RAID. Please note only the RAID5 supports private hotspare.
- Global hotspare: It is not for just one RAID. It is for all RAID disks.

Tips

Click the  to delete the hotspare disk.

4.16.6 iSCSI

Note

iSCSI function is for some series product only.

You can set the network mapping HDD so that device can storage audio/video on the network HDD.

From Main menu->Setting->Storage->iSCSI, you can go to the following interface. See Figure 4-192.

- Server IP address: It is to input iSCSI server IP address.
- Port: It is to input iSCSI server port value. The default setup is 3260.
- User name/password: It is to input iSCSI server user name and password. Check the

Anonymous button if it supports anonymous login.

- Set path: You can click the Set path button to select the remote storage path. Please note each path here stands for one iSCSI share disk. The path has been generated when it is created at the server.
- Add: After you input the above information, click add button to add the new information to the list.

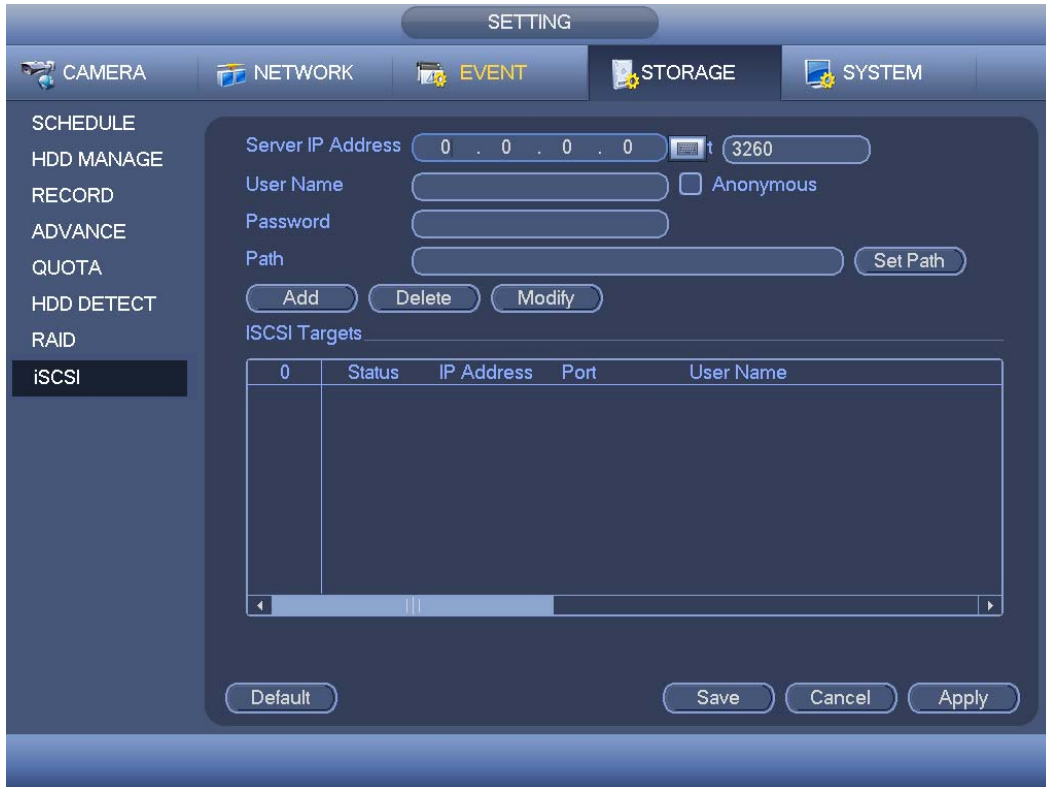

Figure 4-192

Click Ok button to complete the setup.

Tips

Click the modify/delete button to change or remove the iSCSI disk.

Now, from the main menu->setting->Storage->HDD manage, you can see the corresponding interface.

4.17 Channel Manager

It is to set each channel image effect and video connection mode.

4.17.1 Image

Note

For different cameras, the interface may vary.

It is to set camera parameters and adjust video effect.

From main menu->Setting->Camera->Image, for analog channel, the camera interface is shown as in Figure 4-193. For digital channel, the camera interface is shown as in Figure 4-194.

- Channel: Select a channel from the dropdown list.
- Saturation: It is to adjust monitor window saturation. The value ranges from 0 to 100. The default value is 50. The larger the number, the stronger the color is. This value has no effect on the general brightness of the whole video. The video color may become too strong if the value is too high. For the grey part of the video, the distortion may occur if the white balance is not accurate. Please note the video may not be attractive if the value is too low. The recommended value ranges from 40 to 60.
- Brightness: It is to adjust monitor window bright. The value ranges from 0 to 100. The default value is 50. The larger the number is, the brighter the video is. When you input the value here, the bright section and the dark section of the video will be adjusted accordingly. You can use this function when the whole video is too dark or too bright. Please note the video may become hazy if the value is too high. The recommended value ranges from 40 to 60.
- Contrast: It is to adjust monitor window contrast. The value ranges from 0 to 100. The default value is 50. The larger the number is, the higher the contrast is. You can use this function when the whole video bright is OK but the contrast is not proper. Please note the video may become hazy if the value is too low. If this value is too high, the dark section may lack brightness while the bright section may over exposure. The recommended value ranges from 40 to 60.
- Sharpness: The value here is to adjust the edge of the video. The value ranges from 0 to 100. The larger the value is, the clearer the edge is and vice versa. Please note there is noise if the value here is too high. The default value is 50 and the recommended value ranges from 40 to 60.
- Mirror: It is to switch video up and bottom limit. This function is disabled by default.
- Flip: It is to switch video left and right limit. This function is disabled by default. If you want to flip 90°, the resolution shall not be higher than 720P.
- BLC: It includes several options: BLC/WDR/HLC/OFF.
- ✧ BLC: The device auto exposures according to the environments situation so that the darkest area of the video is cleared
- ✧ WDR: For the WDR scene, this function can lower the high bright section and enhance the brightness of the low bright section. So that you can view these two sections clearly at the same time. The value ranges from 1 to 100. When you switch the camera from no-WDR mode to the WDR mode, system may lose several seconds record video.
- ✧ HLC: After you enabled HLC function, the device can lower the brightness of the brightest section according to the HLC control level. It can reduce the area of the halo and lower the brightness of the whole video.
- ✧ OFF: It is to disable the BLC function. Please note this function is disabled by default.
- Profile: It is to set the white balance mode. It has effect on the general hue of the video. This function is on by default. You can select the different scene mode such as

auto, sunny, cloudy, home, office, night, disable and etc to adjust the video to the best quality.

- ✧ Auto: The auto white balance is on. System can auto compensate the color temperature to make sure the vide color is proper.
- ✧ Sunny: The threshold of the white balance is in the sunny mode.
- ✧ Night: The threshold of the white balance is in the night mode.
- ✧ Customized: You can set the gain of the red/blue channel. The value reneges from 0 to 100.
- Day/night. It is to set device color and the B/W mode switch. The default setup is auto.
- ✧ Color: Device outputs the color video.
- ✧ Auto: Device auto select to output the color or the B/W video according to the device feature (The general bright of the video or there is IR light or not.)
- ✧ B/W: The device outputs the black and white video.
- ✧ Sensor: It is to set when there is peripheral connected IR light.
- Image enhancement: It is to enhance video quality. The larger the value is, the clearer the video is. But the noise may become large too.
- 2D NR: It is to process the noise of the single image. The video may become soft after process. The larger the value is, the better the effect is.
- 3D NR: It is to process the multiple-frame (at least two frames). It is to use the frame information between the following two frames to reduce noise. The larger the value is, the better the effect is. The value ranges from 1 to 100. The default value is 50.



Figure 4-193



Figure 4-194

4.17.2 Channel Name

From main menu->Setting->Camera->CAM name, the interface is shown as below. See Figure 4-195. It is to change channel name.

Please note for digital channel, you can only modify the channel name of the connected network camera. The channel name max supports 63 letters.



Figure 4-195

4.17.3 Channel Type

It is to set channel type.

- For analog channel (CVBS signal or HD AVS HD signal), you can select coaxial cable or UTP cable. Please check first and then save setup. There is no need to reboot.
- You can switch analog channel type to digital channel type if you want to connect to network camera. The IP channel shall start from the last channel. System needs to reboot to activate current setup.

Note

If there is no connected channel, the channel type here just displays previous connection record. System supports self-adaptive after camera connection.

From main menu->Setting->Camera->Channel type, the interface is shown as in Figure 4-196 (General series product) or Figure 4-197 (penta-brid series product).

- Auto: It supports self-adaptive function.
- AVS: It supports HD AVS signal input.
- AHD: It supports AHD signal input.
- CVBS: It support standard definition CVBS signal input.
- TVI: It supports TVI signal input.



Figure 4-196



Figure 4-197



Important notice about penta-brid series product:

- Nowadays, there are mainly two analog signal types on today market: analog standard definition (CVBS) and analog HD (AVS, AHD or TVI. For penta-brid series

product, each channel supports all types of signal connection (analog signal/IP signal). For analog signal connection, the default setup is AUTO, that is to say, no matter what analog signal (CVBS, AVS, AHD or other analog HD signal) connected; the penta-brid can automatically recognize the signal and display the proper image. There is no need to set manually.

- If the auto recognition error occurred, penta-brid series product supports manual setup too. The manual setup featuring high recognition speed and usually there is no error. For example, in Figure 4-198, you can set channel 1 to connect to AVS camera, channel 2 to connect to AHD camera, channel 3 to connect to CVBS camera.

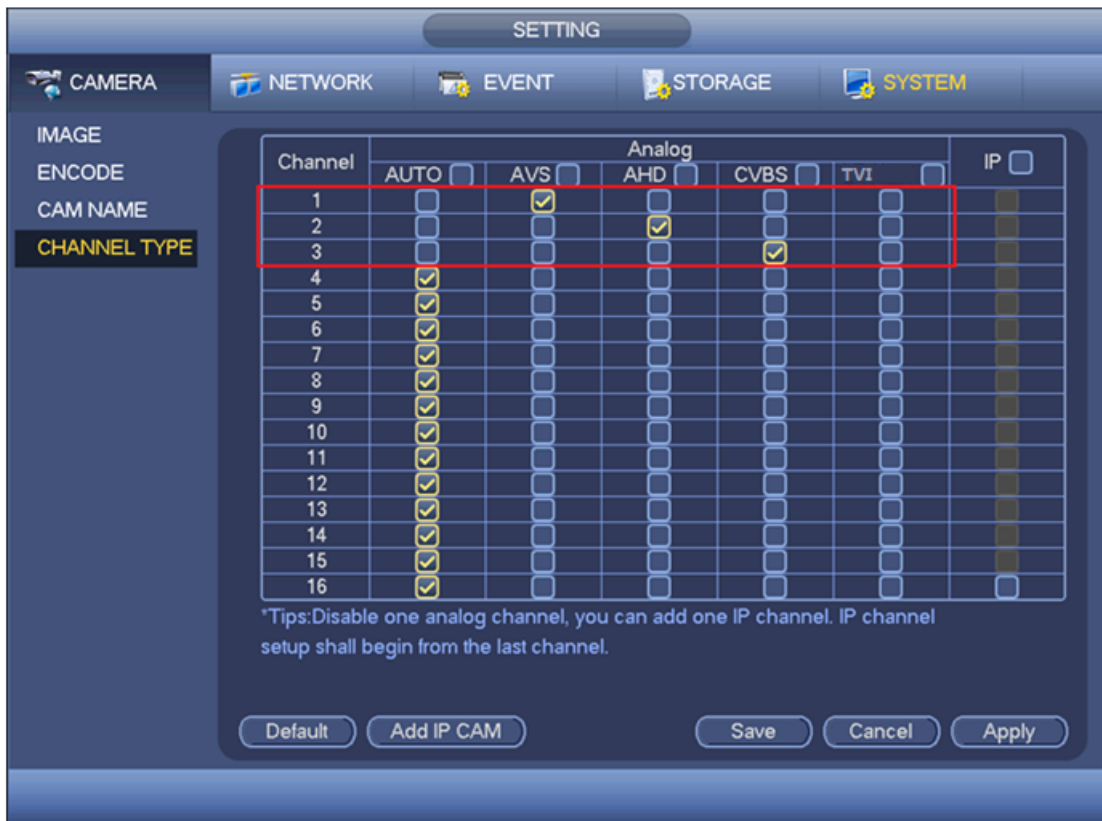

Figure 4-198

Important

Add/cancel IP CAM function is for some series product only.

- Add IP CAM: Click it; you can add corresponding X IP channels. Here X refers to the product channel amount. Please refer to Chapter 1.3 Specifications for IP channel amount information. System needs to restart to activate new setup. See Figure 4-199.



Figure 4-199



Figure 4-200

For example, there is a 4-channel analog device, after the A/D switch, it can max supports 4 analog channels and 4 IP channels. Once it has become the 3+1 mode (3 analog channels+1 IP channel), you click **Add IP CAM** button, system becomes 3+5 mode (3 analog channels+5 IP channel).

- **Cancel IP CAM:** Click it, you can cancel IP channel. System needs to restart to restore original status.



Figure 4-201

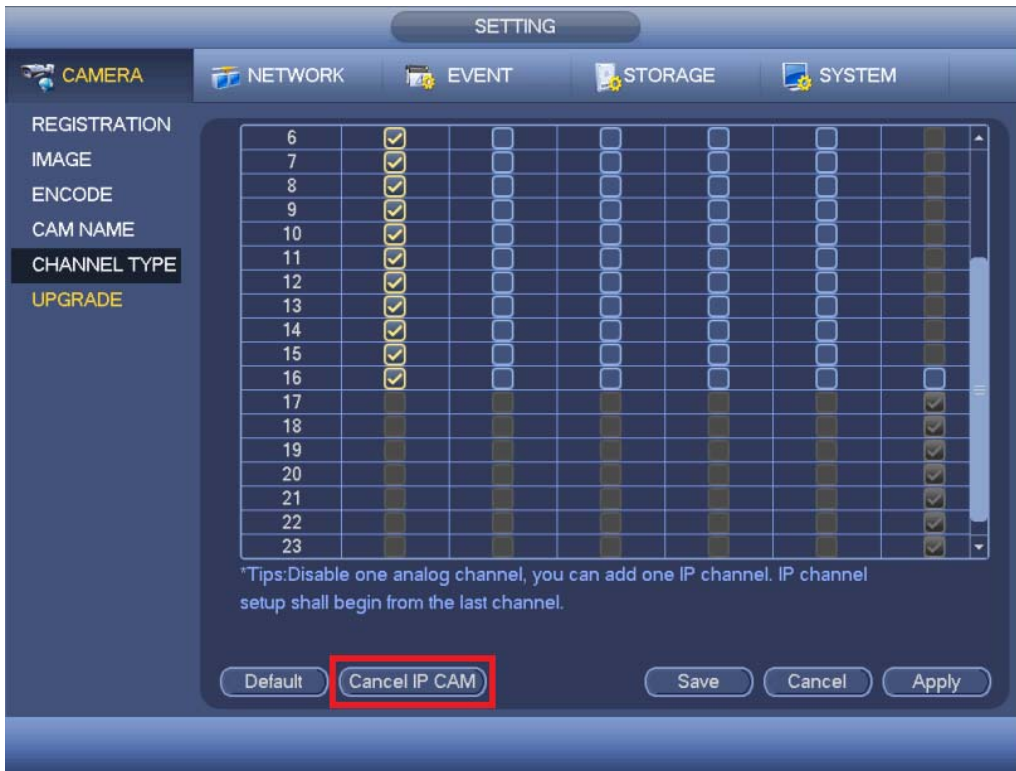

Figure 4-202

4.18 System Settings

4.18.1 RS232

From main menu->Setting->System->RS232, the interface is shown as below. There are five items. See Figure 4-203.

- Function: There are various devices for you to select. Console is for you to use the COM or mini-end software to debug. The control keyboard is for you to control the device via the special keyboard. Transparent COM (adapter) is to directly connect to the PC to transfer data. Protocol COM is for card overlay function. Network keyboard is for you to use the special keyboard to control the device. PTZ matrix is to connect to the peripheral matrix control.
- Baud rate: You can select proper baud rate.
- Data bit: You can select proper data bit. The value ranges from 5 to 8.
- Stop bit: There are two values: 1/2.
- Parity: There are five choices: none/odd/even/space mark.

System default setup is:

- Function: Console
- Baud rate:115200
- Data bit:8
- Stop bit:1
- Parity: None

After completing all the setups please click save button.



Figure 4-203

4.18.2 POS

Connect the DVR with the POS, the DVR can receive the POS information and overlay corresponding info on the video.

Note

- For the local-end, this function supports one-window display and playback only. For the Web, it supports multiple-window display and playback.
- This function is for the cashier of the supermarket and etc. The DVR can get the information from the POS and then overlay the txt information on the video.

From main menu->Setting->System->POS, the interface is shown as below. See Figure 4-204.

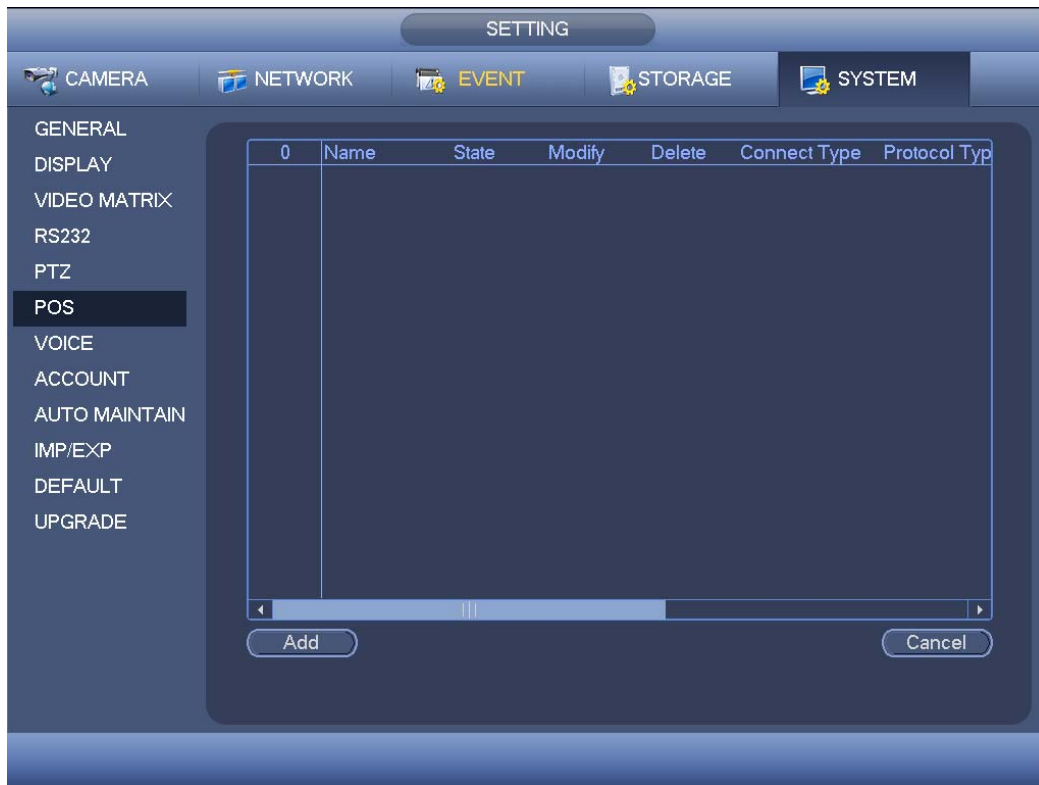

Figure 4-204

Click Add button, the interface is shown as below. See Figure 4-205.

- Enable: Check the box to enable POS function.
- Name: Input POS name. System max supports 63 English letters.
- Connection type: This is for net mode only. Click Setup button, you can set source IP (POS IP address), port is the POS port. Destination IP is the DVR default Ethernet card IP, port is the POS port (read-only). See Figure 4-206.
- Network time out: If there is a network problem, DVR can wait for the specified time you set here to send out the POS information. Once the network time is out, DVR only send out current valid POS information when then network resumes normal.
- Time display: It is to set the POS information displayed time on the video. If you set 5 seconds, then the POS information appears after 5 seconds display.
- Channel Set: Click it to go to Figure 4-207. Select a channel you want to overlay POS information and then click Save button



Figure 4-205

In Figure 4-205, click the Enable box to enable POS function and then input POS device name.

Note

- The POS device name shall be unique.
- POS device name max supports 63-digit.

Click Setup button after the connection type, the interface is shown as in Figure 4-206. Here you can set source IP (POS device IP address) and destination IP (DVR IP address).





Figure 4-206

In Figure 4-205, click Channel setup button, select a channel you want to overlay POS information and then click Save button. See Figure 4-207.



Figure 4-207

Tips

In Figure 4-204, click  to change setup, click  to delete POS setup.

4.19 System Maintain

4.19.1 Auto Maintain

From main menu->Setting->System->Auto maintain, here you can set auto-reboot time and auto-delete old files setup. You can set to delete the files for the specified days. See Figure 4-208.

You can select proper setup from dropdown list.

- Auto Reboot: Select a date and time from the dropdown list, system can auto reboot at the specified time.
- Auto delete old files:
 - Never: Do not auto delete old files.
 - Customized: input customized period here, system can auto delete corresponding old files.

After you completed all the setups, please click Save button.

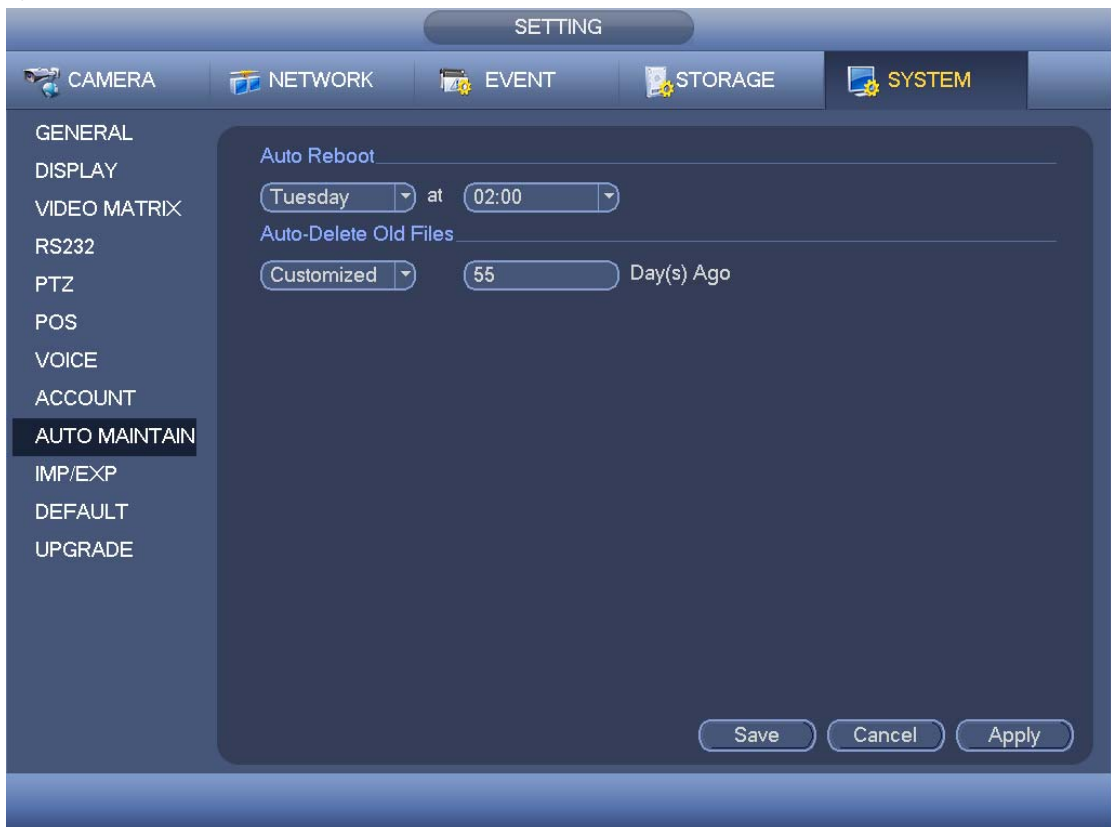

Figure 4-208

4.19.2 Import/Export

From main menu->Setting->System->Import/export, the configuration file backup interface is shown as below. See Figure 4-209.

This function allows you to import/export system configuration. You can use this function when there are several devices need the same setup.

- Export: Please connect the peripheral device first and then go to the following interface. Click Export button, you can see there is a corresponding “Config_Time” folder. Double click the folder, you can view some backup files.
- Import: Here you can import the configuration files from the peripheral device to current device. You need to select a folder first. You can see a dialogue box asking you to select a folder if you are selecting a file. System pops up a dialogue box if there is no configuration file under current folder. After successfully import, system needs to reboot to activate new setup.
- Format: Click Format button, system pops up a dialogue box for you to confirm current operation. System begins format process after you click the OK button.

Note:

- System can not open config backup interface again if there is backup operation in the process.
- System refreshes device when you go to the config backup every time and set current directory as the root directory of the peripheral device.
- If you go to the configuration backup interface first and then insert the peripheral device, please click Refresh button to view the newly added device.

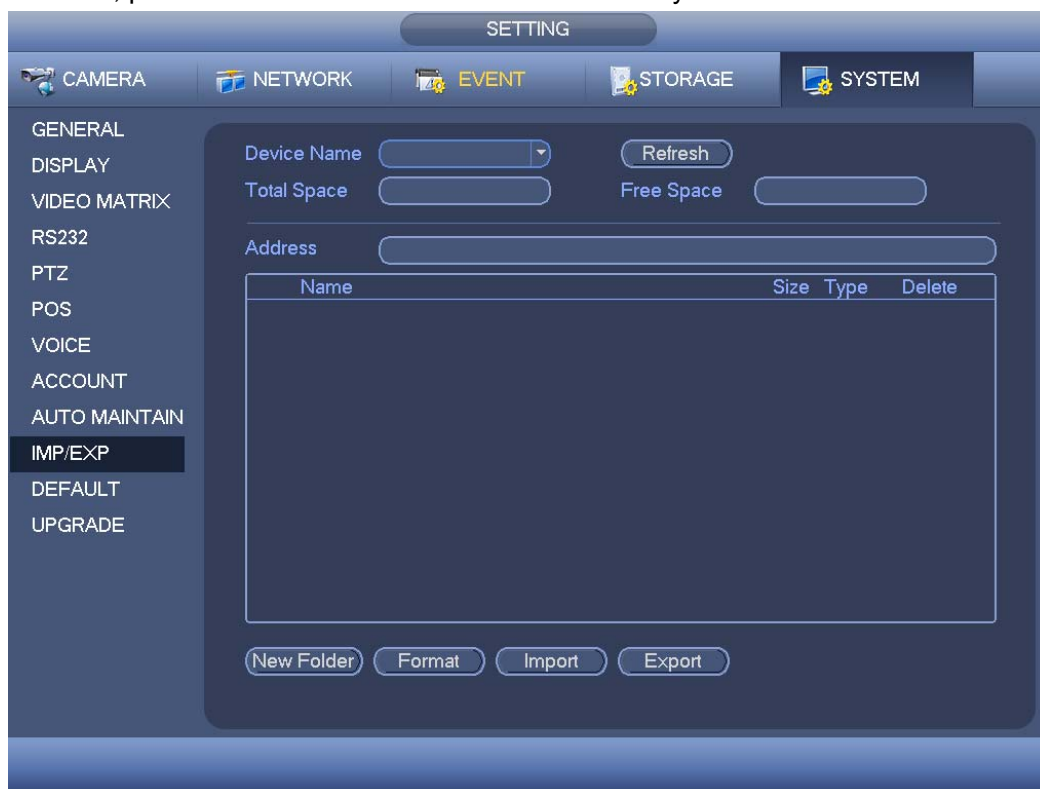

Figure 4-209

4.19.3 Default

From main menu->Setting->System->Default, check the box to restore default factory setup. See Figure 4-210.

- Camera
- Network
- Event
- Storage
- System

Click factory default button, you can restore factory default setup.

After you completed all the setups, please click Save button.



Figure 4-210

4.19.4 System Upgrade

Please upgrade system regularly to guarantee system stability.

4.19.4.1 GUI

From main menu->Setting->System->Upgrade you can see the following interface. See Figure 4-211.

- Start: Please insert the USB device that containing the update file to the device and then click the Start button to begin the update.



Figure 4-211

4.19.4.2 UBoot

When DVR boots up, during the uboot process, it can auto detect the USB device and its corresponding file. System can auto upgrade if it detects the upgrade file.



Important

- In the USB device, there shall be two files: “u-boot.bin.img” and “update.img”
- The USB device shall at the front panel of the device, otherwise, system can not upgrade properly. .





4.20 Remote Device Manager

It is to view remote device running status and upgrade the network camera.

4.20.1 Connection Status

Here you can view the status of the corresponding network camera channel such as motion detect, video loss, tampering, alarm and etc.

From main menu->Setting->Camera->Remote->Status, you can see the following interface. See Figure 4-212..

- IPC status: : Front-end does not support. : Front-end supports. : There is alarm event from current front-end.
- Connection status: : Connection succeeded. : Connection failed.
- Refresh: Click it to get latest front-end channel status.

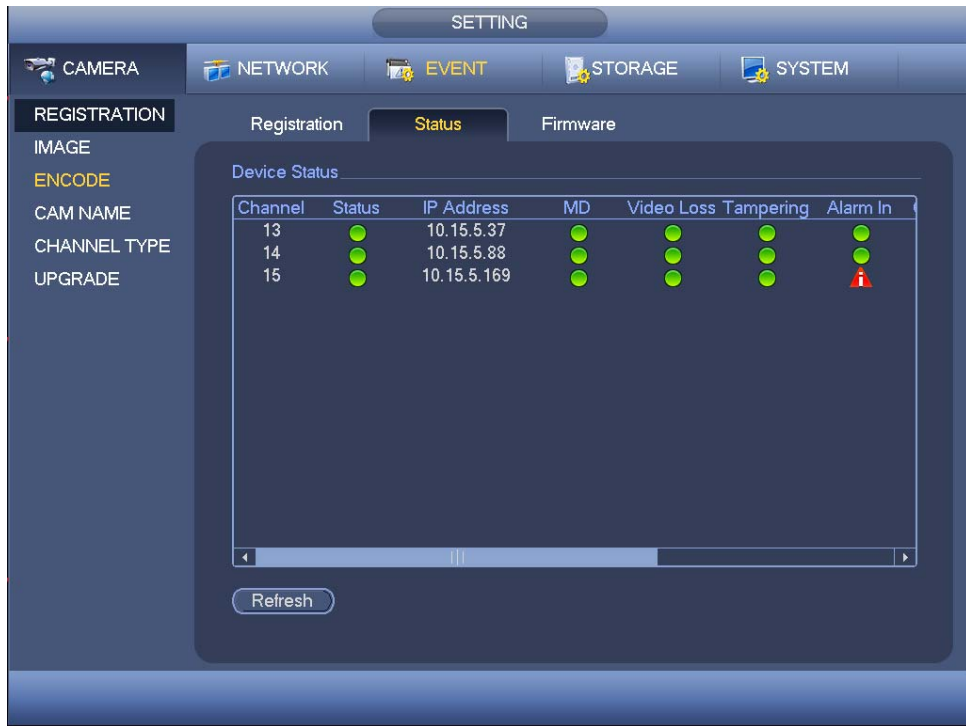

Figure 4-212

4.20.2 Firmware

It is to view channel, IP address, manufacturer, type, system version, SN, video input, audio input, external alarm and etc.

From main menu->Setting->Camera->Remote->Firmware, you can see the following interface. See Figure 4-213.



Figure 4-213

4.20.3 Camera Upgrade

It is to update the network camera.

From main menu->Setting->Camera->Upgrade, the interface is shown as below. See Figure 4-214.

Click Browse button and then select the upgrade file. Then select a channel (or you can select device type filter to select several devices at the same time.)

Click Start upgrade button to update. You can see the corresponding dialogue once the upgrade is finish. If the camera upgrade operation failed, please check the camera connection.



Figure 4-214

4.21 Info

Here you can view system information, event information, network information, log information and etc.

4.21.1 System Info

Here you can view HDD information, record information, bit stream information, version information and etc.

4.21.1.1 HDD Information

From main menu->Info->System->HDD, here is to list hard disk type, total space, free space, video start time and status. See Figure 4-215.

- SN: You can view the HDD amount the device connected to. * means it is current working HDD.
- Type: The corresponding HDD properties.

- Total space: The HDD total capacity.
- Free space: The HDD free capacity.
- Status: HDD can work properly or not.
- SMART: Display HDD information. See Figure 4-216.

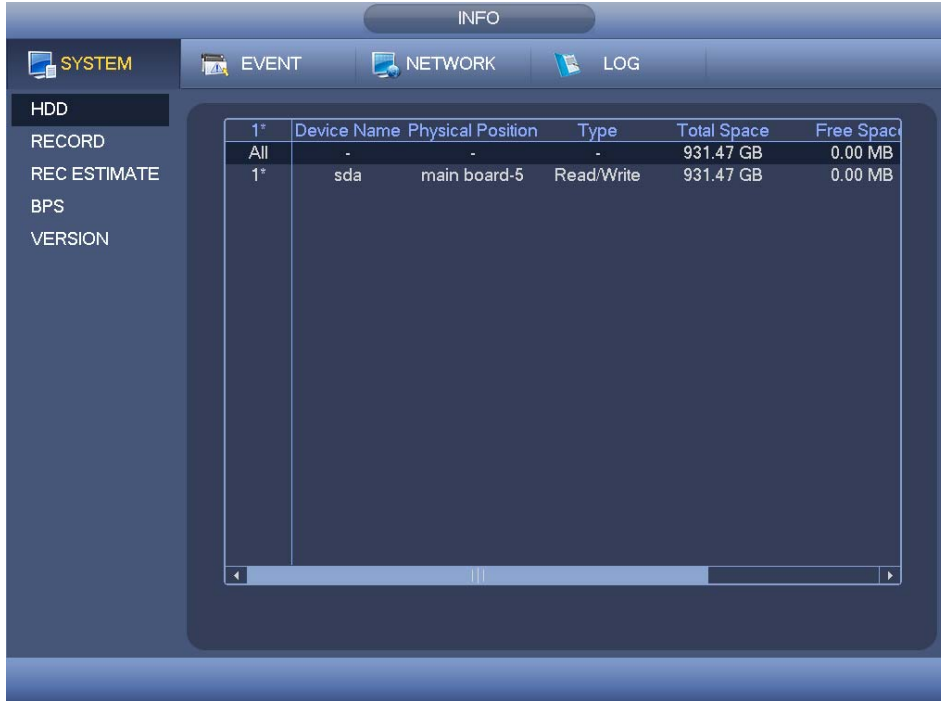



Figure 4-215

Double click , you can see the HDD SMART information. See Figure 4-216.

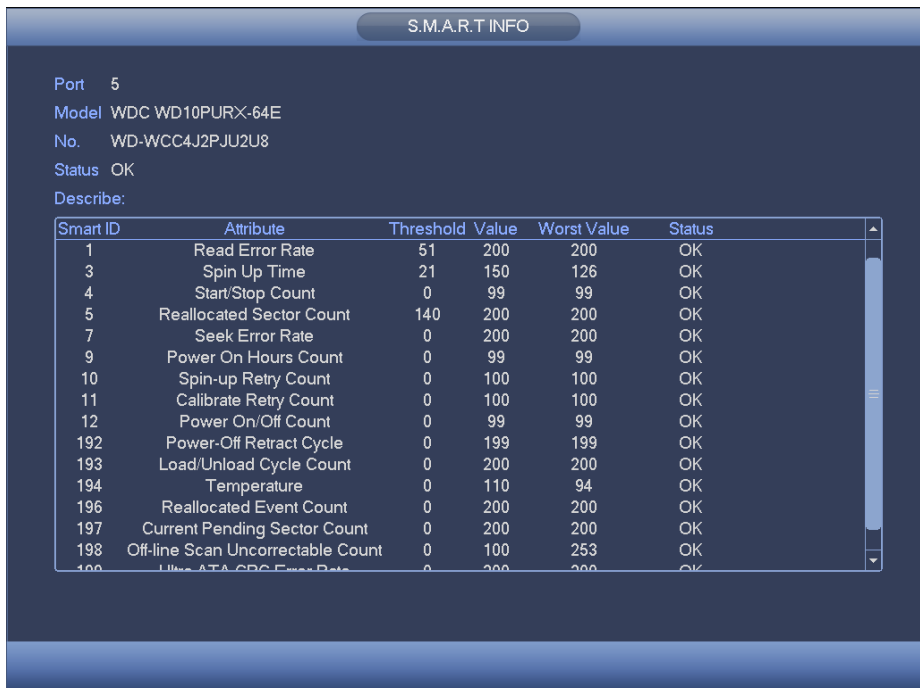

Figure 4-216

4.21.1.2 Record Info

From main menu->Info->System->Record, here is to view record start time and end time. See Figure 4-217.



The screenshot shows a software interface with a top navigation bar labeled 'INFO' and four sub-menus: 'SYSTEM', 'EVENT', 'NETWORK', and 'LOG'. On the left side, there is a vertical menu with options: 'HDD', 'RECORD', 'REC ESTIMATE', 'BPS', and 'VERSION'. The 'RECORD' option is selected, and a table is displayed in the main area. The table has three columns: 'Device Name', 'Start Time', and 'End Time'. The first row is a summary row for 'All' records, and the subsequent rows list individual records for a device named 'sda'.

	Device Name	Start Time	End Time
All		2016-06-08 15:17:16	2016-06-23 14:23:14
1*	sda	2016-06-23 00:34:00	2016-06-23 11:33:40
	sda	2016-06-23 11:32:37	2016-06-23 13:49:16
	sda	2016-06-08 15:17:16	2016-06-10 14:14:17
	sda	2016-06-23 13:50:28	2016-06-23 14:23:14
	sda	2016-06-10 14:46:39	2016-06-12 12:23:19
	sda	2016-06-12 12:19:27	2016-06-13 09:05:29
	sda	2016-06-13 09:01:33	2016-06-14 20:29:21
	sda	2016-06-14 20:29:21	2016-06-20 19:00:06
	sda	2016-06-22 10:36:07	2016-06-23 00:34:00

Figure 4-217

4.21.1.3 Record Estimate

System can calculate the record time based on the HDD space, or you can input the record time you want to calculate the HDD space you need.

From main menu->Info->System->Record estimation, you can go to the following interface. See Figure 4-218.



Figure 4-218

Click  after the channel name, system pops up Edit dialogue box. See Figure 4-140. You can input resolution, frame rate, bit stream, record time of the corresponding channel, system can calculate the record time based on the channel setup and HDD space.



Figure 4-219

- **Calculate the record period based on the HDD space**

Check the channel you want to record file.

Click Known Space and then click the  button to set HDD. Click OK button. Now you can see the record period (such as 5 days). See Figure 4-220.



Figure 4-220

- **Calculate the HDD space based on the record period**

Check the channel you want to record file.

Input days(s) you want to records, system can auto calculate the HDD space needed (such as 5.109TB). See Figure 4-221.



Figure 4-221

4.21.1.4 BPS

From main menu->Info->System->BPS, here is for you to view current video data stream (KB/s) and resolution. See Figure 4-222.

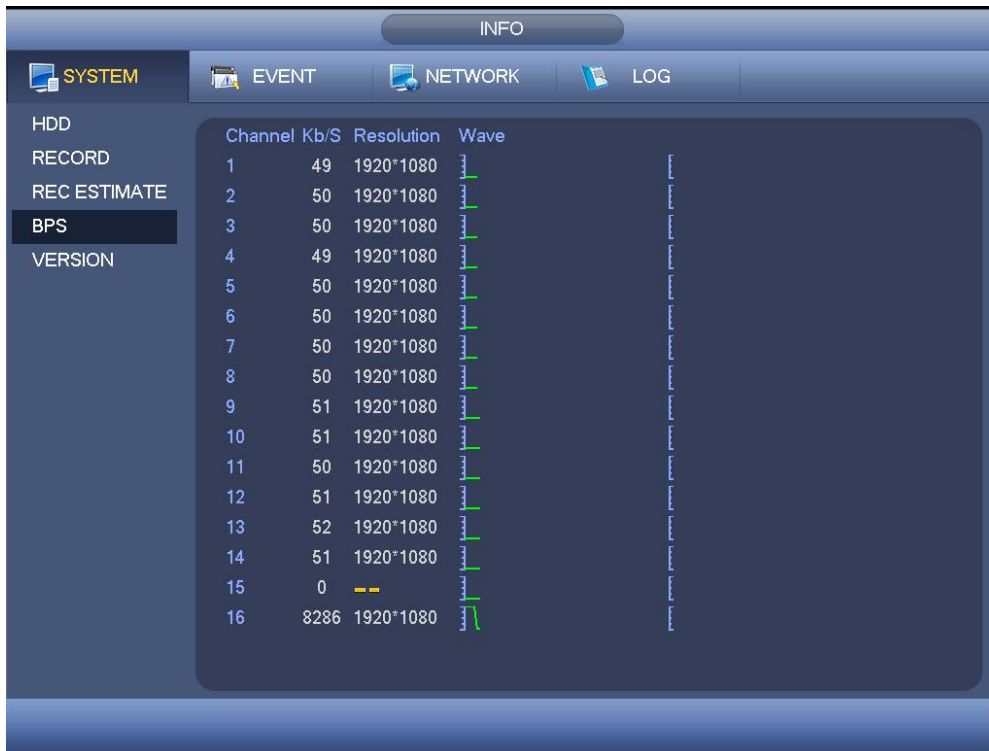

Figure 4-222

4.21.1.5 Device Status

Note

This function is for some series product only.

From main menu->Info->System->Status, here is for you to view fan status, power status, CPU usage, temperature and etc. See Figure 4-223.



Figure 4-223

4.21.1.6 Version

From main menu->Info->System->Version, here is for you to view some version information such as version number, built date, serial number and etc. See Figure 4-224.



Figure 4-224

4.21.2 Event Info

4.21.2.1 Event

From main menu->Info->Event->Event, it is to display device status and channel status. See Figure 4-225.

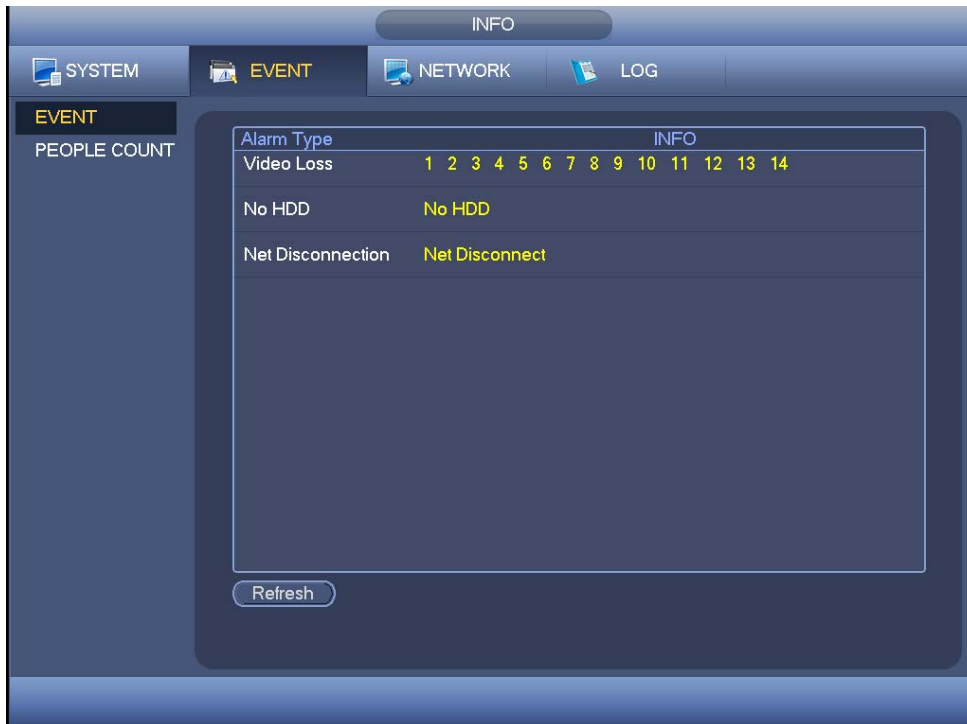

Figure 4-225

4.21.2.2 People Counting

It is to search and view the people counting results of each channel. System can export people counting report. The export file extension name is .bmp.

From main menu->Info->Event->People Counting, you can go to the following interface. See Figure 4-226.

- Channel: Please select a channel from the dropdown list to search people counting result.
- Report type: Please select report type from the dropdown list. It includes daily report, monthly report, and annual report. And then select histogram graph and polygon graph. Please note the daily report max supports 24 hours.
- Start time/end time: Input the people counting start time and end time.
- Flow direction: Check the box to set flow direction such as enter/exit.
- Display number: Check the box, the DVR can display the enter and exit people amount in the report.
- Search: Click Search button, you can view the people counting report at the bottom of the interface.
- Export: Click it and then select path, click Save button to save people counting report to your local PC.



Figure 4-226

4.21.3 Network Info

4.21.3.1 Online Users

From main menu->Info->Network->Online users, here is for you to manage online users. See Figure 4-227.

You can disconnect one user or block one user if you have proper system right. Max disconnection setup is 65535 seconds.

System detects there is any newly added or deleted user in each five seconds and refresh the list automatically.

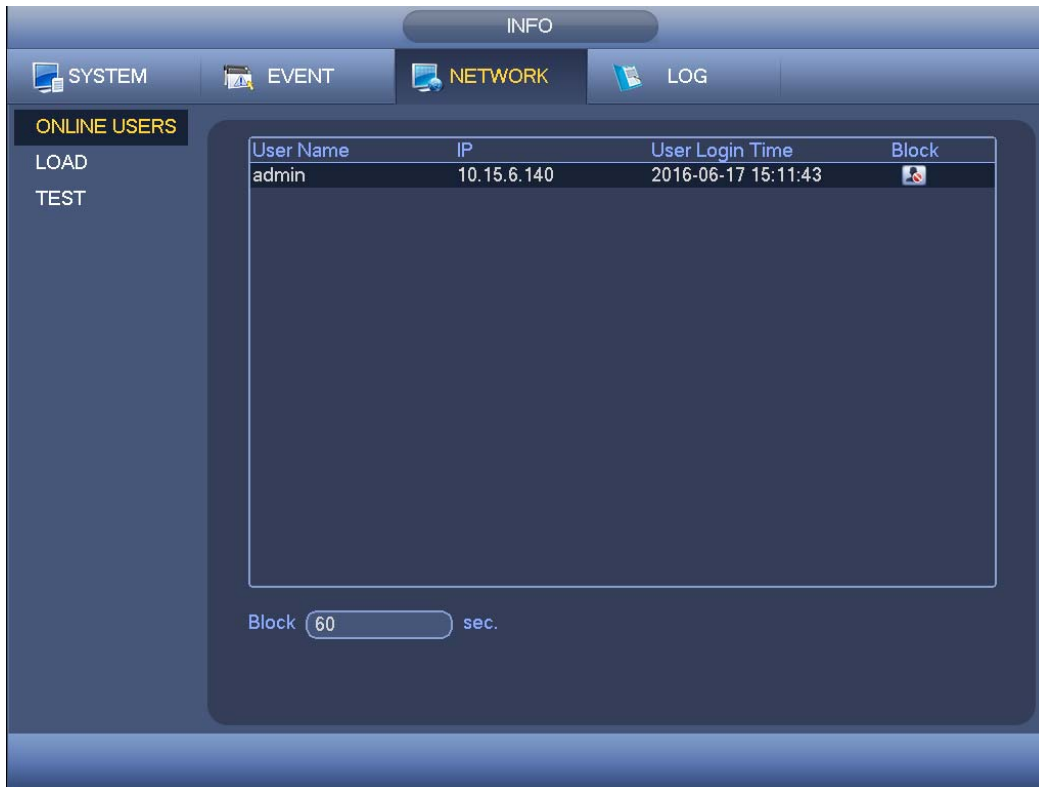

Figure 4-227

4.21.3.2 Network Load

From main menu->Info->Network->Load, network load is shown as in Figure 4-228. Here you can view the follow statistics of the device network adapter.

Here you can view information of all connected network adapters. The connection status is shown as offline if connection is disconnected. Click one network adapter, you can view the flow statistics such as send rate and receive rate at the top panel.

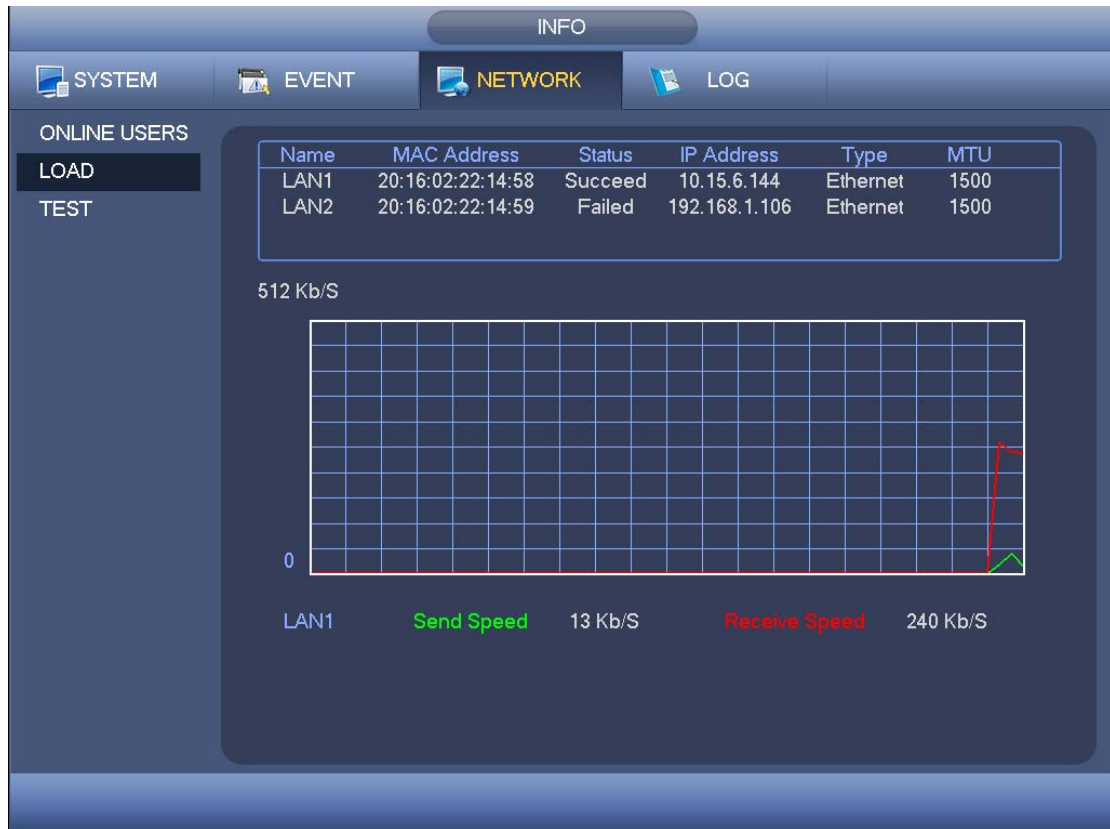



Figure 4-228

4.21.3.3 Network Test

From main menu->Info->Network->Test, network test interface is shown as in Figure 4-229.

- Destination IP: Please input valid IPV4 address or domain name.
- Test: Click it to test the connection with the destination IP address. The test results can display average delay and packet loss rate and you can also view the network status as OK, bad, no connection and etc.
- Network Sniffer backup: Please insert USB2.0 device and click the Refresh button, you can view the device on the following column. You can use the dropdown list to select peripheral device. Click Browse button to select the snap path. The steps here are same as preview backup operation.

You can view all connected network adapter names (including Ethernet, PPPoE, WIFI, and 3G), you can click the button  on the right panel to begin Sniffer. Click the grey stop button to stop. Please note system can not Sniffer several network adapters at the same time.

After Sniffer began, you can exit to implement corresponding network operation such as login WEB, monitor. Please go back to Sniffer interface to click  stop Sniffer. System can save the packets to the specified path. The file is named after "Network adapter name+time". You can use software such as Wireshark to open the packets on the PC for

the professional engineer to solve complicated problems.

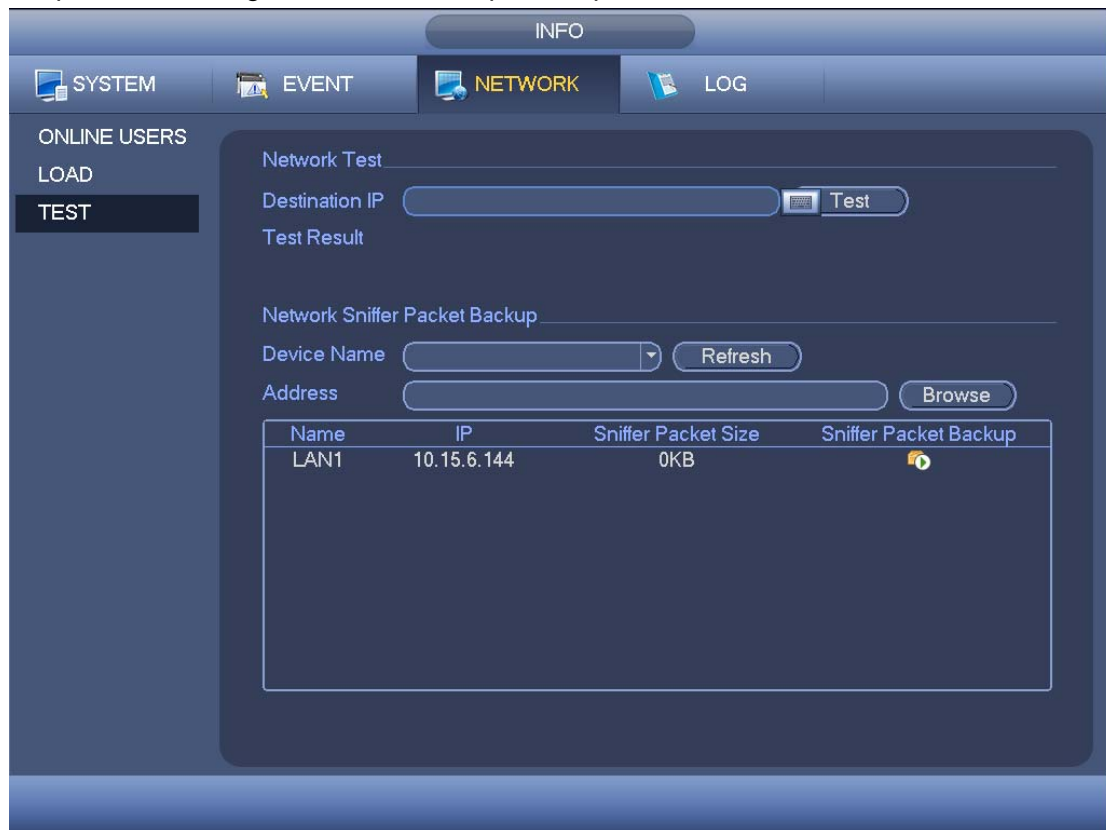

Figure 4-229

4.21.4 Log Info

Note

- If there is no HDD, system max supports 10,000 logs.
- If you have connected to the formatted HDD, system max supports 500,000 logs.
- System operation logs are saved in system memory. Other types of logs are saved in the HDD. If there is no HDD, other types of logs are saved in the system memory media.
- The logs are safe when you format the HDD. But the logs may become loss once you removed the HDD from the device.

From main menu->Info->Log->Log, here is for you to view system log file. System lists the following information. See Figure 4-230.

Log types include system operation, configuration operation, data management, alarm event, record operation, account manager, log clear, file operation and etc. It optimized reboot log. There are only three types: normal reboot, abnormal reboot and protection reboot. 0x02、0x03、0x04 is included in the protection reboot type.

- Start time/end time: Pleased select start time and end time, then click search button. You can view the log files in a list. System max displays 100 logs in one page. It can max save 1024 log files. Please use page up/down button on the interface or the front panel to view more.

- Backup: Please select a folder you want to save; you can click the backup button to save the log files. After the backup, you can see there is a folder named Log_time on the backup path. Double click the folder, you can see the log file
- Details: Click the Details button or double click the log item, you can view the detailed information. See Figure 4-231. Here you can use rolling bar to view information, or you can use Page up/Page down to view other log information.



Figure 4-230

Select an item on the list and then click the Details button or double click the log item, you can view the detailed information such as log time, log type, log user, IP address and etc. See Figure 4-231.



Figure 4-231

4.22 Shutdown

On the main menu, click Shutdown, you can go to the following interface. See Figure 4-232.

There are three options: Shutdown/logout/reboot.

For the user who does not have the shut down right, please input corresponding password to shut down.



Figure 4-232

Auto Resume after Power Failure

The system can automatically backup video and resume previous working status after power failure.

5 WEB OPERATION

Slightly difference may be found in the interface due to different series.

5.1 Network Connection

Before web client operation, please check the following items:

- Network connection is right
- DVR and PC network setup is right. Please refer to network setup(main menu->Setting->Network)
- Use order ping `***.***.***.***`(* DVR IP address) to check connection is OK or not. Usually the return TTL value should be less than 255.

5.2 Set Password and Login

Open IE and input DVR address in the address column. For example, if your DVR IP is 10.10.3.16, then please input `http:// 10.10.3.16` in IE address column.

System pops up warning information to ask you whether install control or not. Please click Install button. See Figure 5-1.

Note

- DVR default IP address is 192.168.1.108.
- Current series product supports various browsers such as Safari, fire fox browser, Google browser. Device supports multiple-channel monitor, PTZ control, DVR parameter setup on the Apple PC.

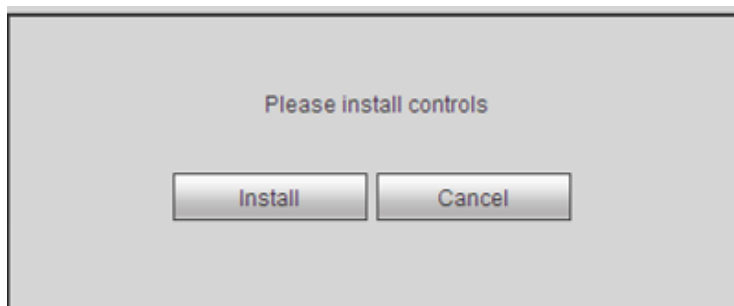

Figure 5-1

After installation, the interface is shown as below. See Figure 5-2.

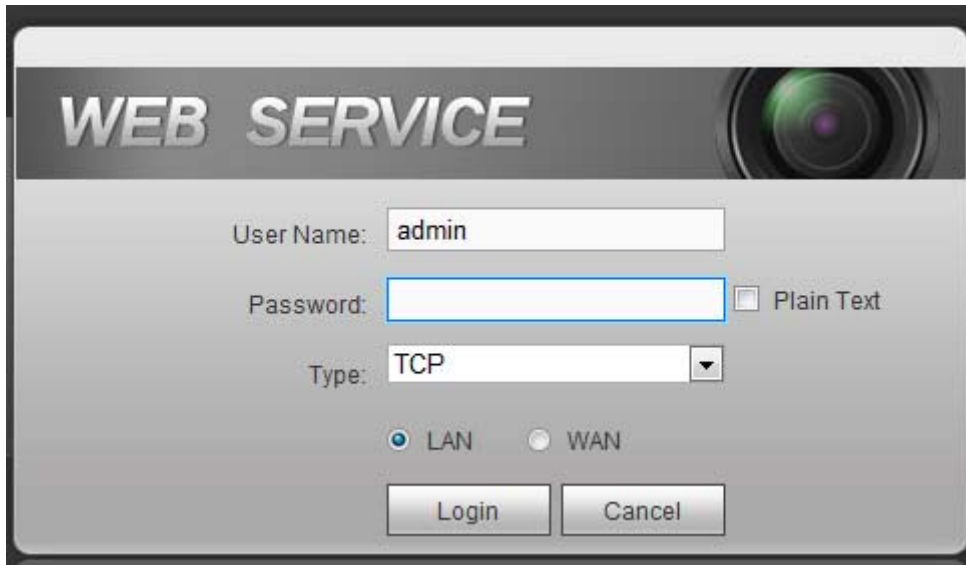

Figure 5-2

System pops up the following dialogue box for you to set administrator password. See Figure 5-3.



Figure 5-3

Please input password twice to set a password and then click Save button to complete the setup.

5.3 Preview

5.3.1 LAN Mode

For the LAN mode, after you logged in, you can see the main window. See Figure 5-4.

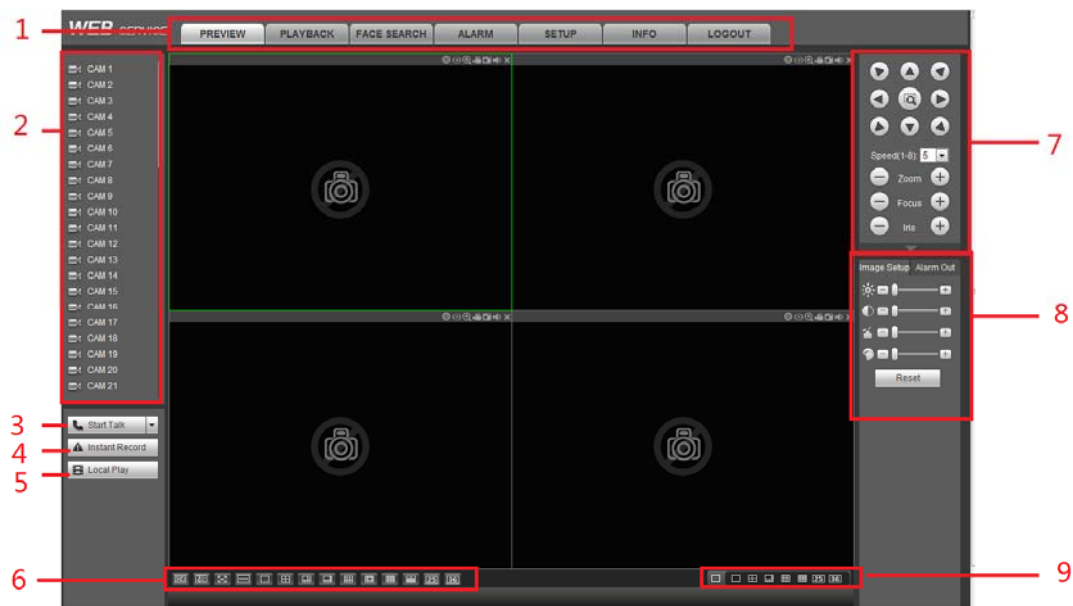

Figure 5-4

Please refer to the following sheet for detailed information.

SN	Name	SN	Name
1	System menu	2	Realtime monitor channel
3	Bidirectional talk	4	Instant record
5	Local playback	6	Switch monitor window
7	PTZ control	8	Image setup /alarm output
9	Zero-channel encoding		

5.3.1.1 System Menu

The system menu interface is shown as below. See Figure 5-153.

Please refer to chapter 5.3.1.2 Preview,, chapter 5.5 setup , chapter 5.6 search, chapter 5.7 Alarm, chapter 5.4 Face search and chapter 5.9 Logout for detailed information.



Figure 5-5

5.3.1.2 Real-time Monitor

Left click the channel name on the left pane of the main interface; you can see the corresponding video in current window.

On the top left corner, you can view device IP, channel number, network monitor bit stream. See Figure 5-6.



Figure 5-6

Please refer to the following sheet for detailed information.

	Name	Function
1-4	Display device information	When there is video, it is to display “Device IP-Monitor channel number-network bit stream-decode mode”. Otherwise, it shows as “No video”.
5	Smart track	Click it to view the smart track video.
6	Fisheye	Click it to set fisheye installation mode and display mode.
7	Digital zoom	Click this button and then left drag the mouse in the zone to zoom in. right click mouse system restores original status.
8	Local record	When you click local record button, the system begins recording and this button becomes highlighted. You can go to system folder RecordDownload to view the recorded file.
9	Snapshot	You can snapshot important video. All images are memorized in system client folder PictureDownload (default).
10	Audio	Turn on or off audio. Note: It has no relationship with system audio setup.
11	Close video	Close video

Open All

Open all button is to enable/disable all-channel real-time monitor. Click it the button becomes yellow. See Figure 5-7.

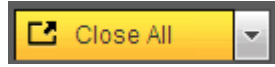

Figure 5-7

Main stream/sub stream

Please refer to Figure 5-8 for main stream and extra stream switch information.

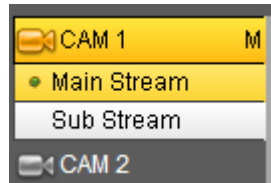

Figure 5-8

5.3.1.3 Start dialogue

You can click this button to enable audio talk. Click 【▼】 to select bidirectional talk mode. There are four options: DEFAULT, G711a, G711u and PCM. After you enable the bidirectional talk, the Start talk button becomes End Talk button and it becomes yellow. See Figure 5-9.

Please note, if audio input port from the device to the client-end is using the first channel audio input port. During the bidirectional talk process, system will not encode the audio data from the 1-channel.

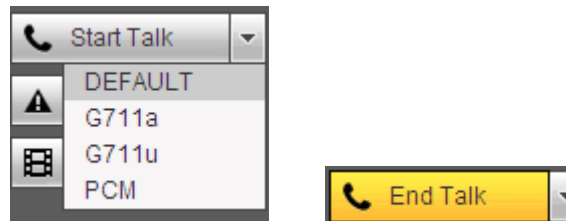

Figure 5-9

5.3.1.4 Instant record

Click it, the button becomes yellow and system begins manual record. See Figure 5-10. Click it again, system restores previous record mode..

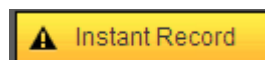

Figure 5-10

5.3.1.5 Local play

The Web can playback the saved (Extension name is dav) files in the PC-end. Click local play button, system pops up the following interface for you to select local play

file. See Figure 5-11.



Figure 5-11

5.3.1.6 Switch monitor window

From the left to the right ,you can see video quality/fluency/ full screen/tilt sync/1-window/4-window/6-window/8-window/9-window/13-window/16-window/20-window/25-window/36-window.. You can set video fluency and real-time feature priority. See Figure 5-12.

Note

The following interface may vary due to different series product.



Figure 5-12

5.3.1.7 PTZ

Before PTZ operation, please make sure you have properly set PTZ protocol. (Please refer to chapter 5.5.5.5).

There are eight direction keys. In the middle of the eight direction keys, there is a 3D intelligent positioning key.

Click 3D intelligent positioning key, system goes back to the single screen mode. Drag the mouse in the screen to adjust section size. It can realize PTZ automatically.

Please refer to the following sheet for PTZ setup information.

Parameter	Function
Scan	<ul style="list-style-type: none"> ● Select Scan from the dropdown list. ● Click Set button, you can set scan left and right limit. ● Use direction buttons to move the camera to you desired location and then click left limit button. Then move the camera again and then click right limit button to set a right limit.
Preset	<ul style="list-style-type: none"> ● Select Preset from the dropdown list. ● Turn the camera to the corresponding position and Input the preset value. Click Add button to add a preset.

Parameter	Function
Tour	<ul style="list-style-type: none"> ● Select Tour from the dropdown list. ● Input preset value in the column. Click Add preset button, you have added one preset in the tour. ● Repeat the above procedures you can add more presets in one tour. ● Or you can click delete preset button to remove one preset from the tour.
Pattern	<ul style="list-style-type: none"> ● Select Pattern from the dropdown list. ● You can input pattern value and then click Start button to begin PTZ movement such as zoom, focus, iris, direction and etc. Then you can click Add button to set one pattern.
Aux	<ul style="list-style-type: none"> ● Please input the corresponding aux value here. ● You can select one option and then click AUX on or AUX off button.
Light and wiper	You can turn on or turn off the light/wiper.

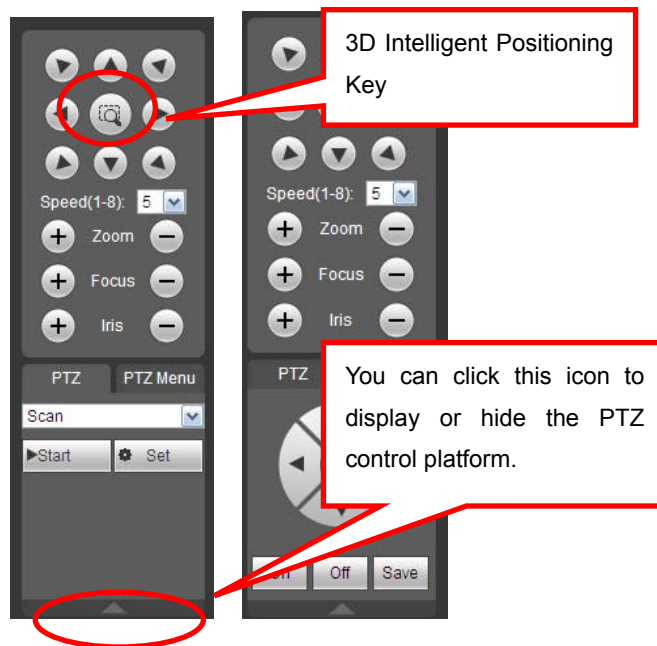

Figure 5-13

5.3.1.8 Image

Here you can adjust its brightness, contrast, hue and saturation. (Current channel border becomes green). See Figure 5-14.

Or you can click Reset button to restore system default setup.



Figure 5-14

5.3.1.9 Relay output

Here you can enable or disable the alarm signal of the corresponding port. See Figure 5-15.



Figure 5-15

5.3.1.10 Zero-channel encoding

This function allows you to view several-channel in one window. It supports 1/4/8/9-channel mode. Please go to chapter 4.3.8.4 (local menu) or chapter 5.5.5.2.4 (Web) to enable zero-channel encoding function first.

5.3.2 WAN Login

In WAN mode, after you logged in, the interface is shown as below. See Figure 5-16.

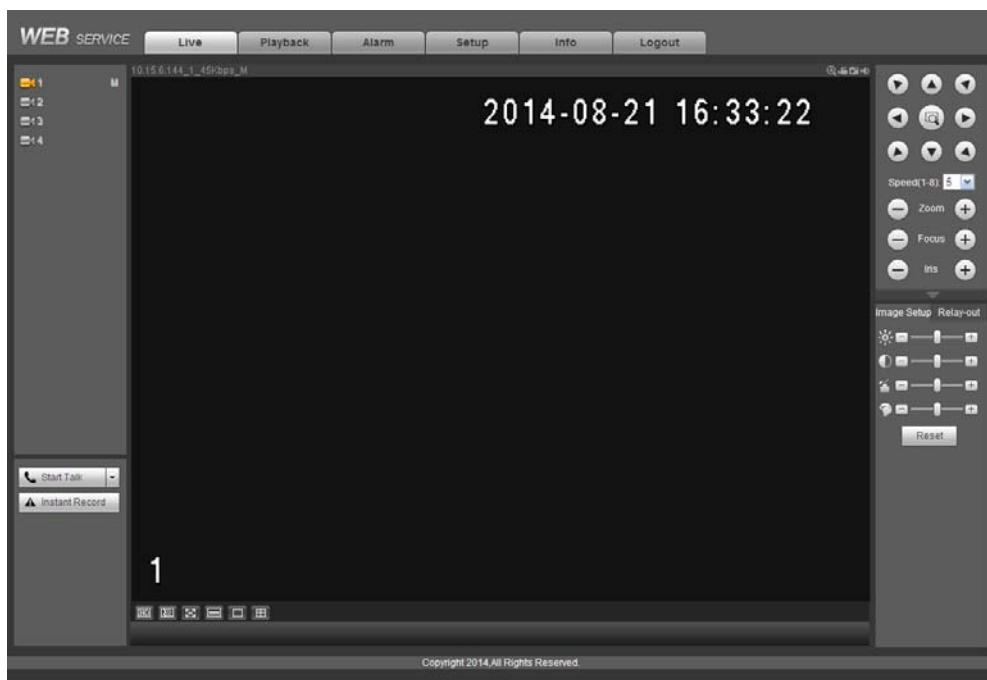

Figure 5-16

Please refer to the following contents for LAN and WAN login difference.

- The window display mode and the channel number are by default. For example, for the 16-channel, the max window split mode is 16.
- For multiple-channel monitor, system adopts sub stream to monitor by default. Double click one channel, system switches to single channel and system uses main stream to monitor. You can view there are two icons at the left top corner of the channel number for you reference. M stands for main stream. S stands for sub stream (extra stream).

Important

- For multiple-channel monitor mode, system adopts extra stream to monitor by default. You can not modify manually. All channels are trying to synchronize. Please note the synchronization effect still depends on your network environments.
- For bandwidth consideration, system can not support monitor and playback at the same time. System auto closes monitor or playback interface when you are searching setup in the configuration interface. It is to enhance search speed.

5.4 Search Human Face

On the main interface, click Face search button, you can see an interface shown as below. See Figure 5-17.

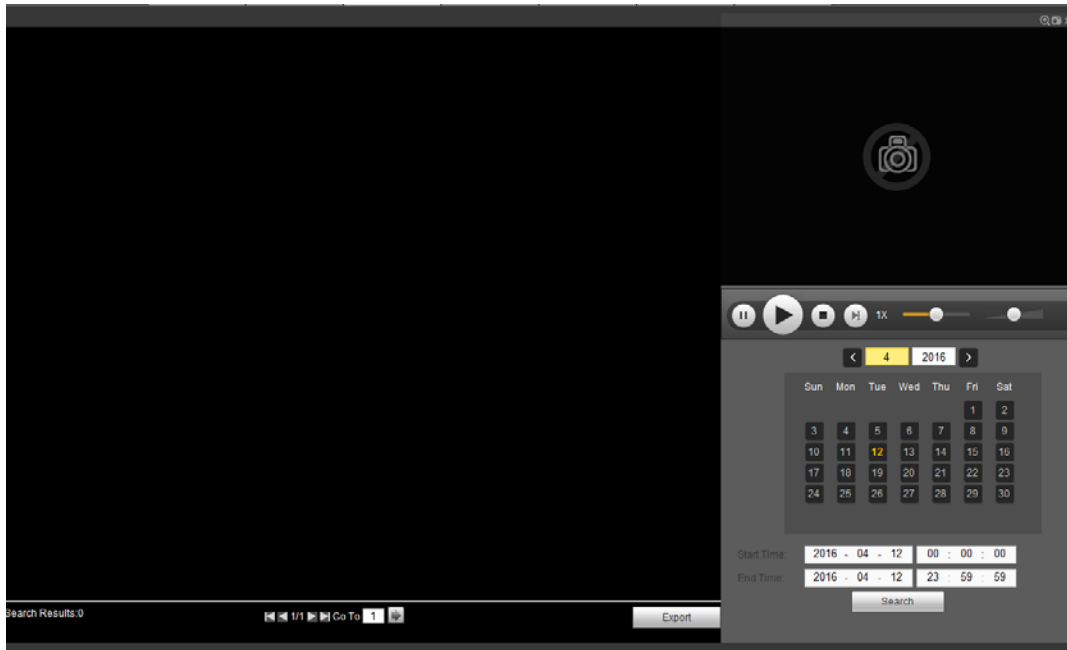



Figure 5-17

Please refer to the following sheet for detailed information.

SN	Name	Function
----	------	----------

SN	Name	Function
1	Display pan	<ul style="list-style-type: none"> It is to display human face detection file list. The latest file is at the bottom. Click Export, you can export the selected file to the USB device. There are two types: image/record. <ul style="list-style-type: none"> Image: Export the recognized human face image. Record: Export the record file before and after 10 seconds when the DVR recognizes the human face.
2	Playback pane	Play the searched record file or image. Double click or click  to playback.
3	Search pane	Set date, start time and end time, click Search button, you can view the corresponding file list.

5.5 Setup

Here is to introduce DVR basic setups and system configurations.

5.5.1 Camera

It is to add network camera, set camera properties and set encode parameters.

5.5.1.1 Registration (For digital channel only)

Please go to main menu->Setting->Camera->Channel type to enable IP channel function, otherwise you can not see the following interface.

Here you can add network camera automatically or manually, set/delete corresponding information and upgrade network camera.

From main window->Setup->Camera->Registration, registration interface is shown as below. See Figure 5-18.

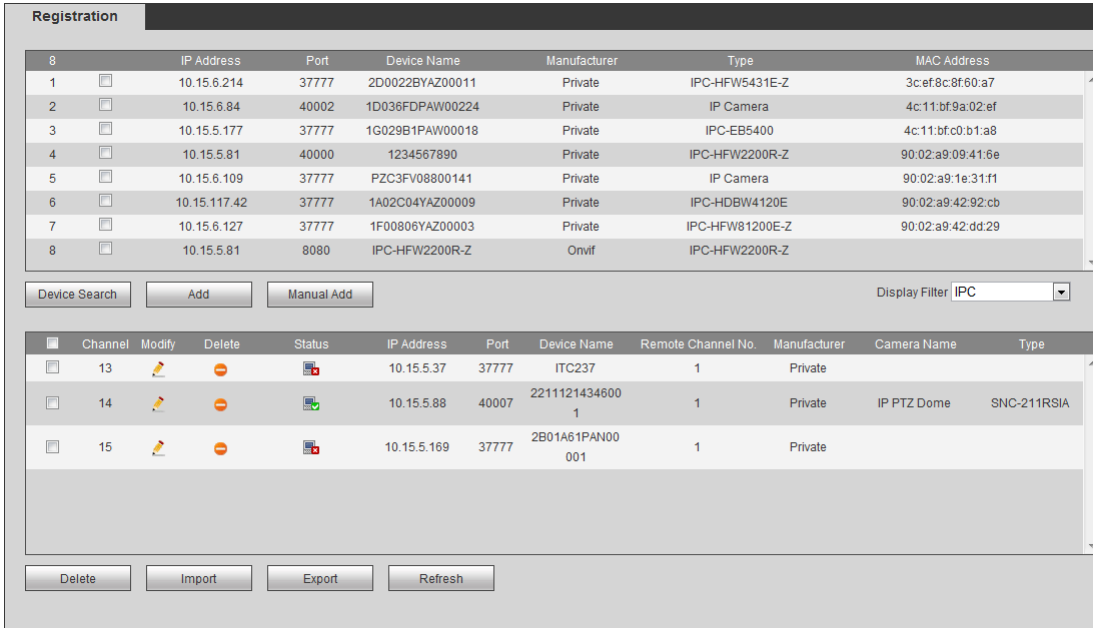

The screenshot shows the 'Registration' interface with two main sections. The top section is a table listing registered devices:

8	IP Address	Port	Device Name	Manufacturer	Type	MAC Address
<input type="checkbox"/>	10.15.6.214	37777	2D0022BYAZ00011	Private	IPC-HFW5431E-Z	3cef8c8f60a7
<input type="checkbox"/>	10.15.6.84	40002	1D036FDPAW00224	Private	IP Camera	4c11:bf9a:02:ef
<input type="checkbox"/>	10.15.5.177	37777	1G029B1PAW00018	Private	IPC-EB5400	4c11:bf:c0:b1:a8
<input type="checkbox"/>	10.15.5.81	40000	1234567890	Private	IPC-HFW2200R-Z	90:02:a9:09:41:5e
<input type="checkbox"/>	10.15.6.109	37777	PZC3FV08800141	Private	IP Camera	90:02:a9:1e:31:f1
<input type="checkbox"/>	10.15.117.42	37777	1A02C04YAZ00009	Private	IPC-HDBW4120E	90:02:a9:42:92:cb
<input type="checkbox"/>	10.15.6.127	37777	1F00806YAZ00003	Private	IPC-HFW81200E-Z	90:02:a9:42:dd:29
<input type="checkbox"/>	10.15.5.81	8080	IPC-HFW2200R-Z	Onvif	IPC-HFW2200R-Z	

Below the table are buttons for 'Device Search', 'Add', and 'Manual Add', along with a 'Display Filter' dropdown set to 'IPC'. The bottom section shows a list of channels:

Channel	Modify	Delete	Status	IP Address	Port	Device Name	Remote Channel No.	Manufacturer	Camera Name	Type
<input type="checkbox"/> 13				10.15.5.37	37777	ITC237	1	Private		
<input type="checkbox"/> 14				10.15.5.88	40007	22111214346001	1	Private	IP PTZ Dome	SNC-211RSIA
<input type="checkbox"/> 15				10.15.5.169	37777	2B01A61PAN0001	1	Private		

At the bottom are buttons for 'Delete', 'Import', 'Export', and 'Refresh'.

Figure 5-18





The image shows a 'Manual Add' dialog box with the following fields and values:

- Channel: 18
- Manufacturer: Private
- IP Address: 192.168.0.0
- TCP Port: 37777 (range: 1~65535)
- User Name: admin
- Password: •••••
- Remote Channel No.: 1
- Decode Buffer: 280 ms (range: 80~480)

Buttons: Save, Cancel

Figure 5-19

Please refer to the following sheet for log parameter information.

Parameter	Function
Device search	Click Device search button, you can view the searched device information on the list. It includes device IP address, port, device name, manufacturer and type.
Add	Select a device in the list and then click Add button, system can connect the device automatically and add it to the Added device list. Or you can double click one item in the list to add a device.
Modify	Click  or any device in the Added device list, you can change the corresponding channel setup.
Delete	Click  , you can delete the remote connection of the corresponding channel.
Connection status	 : Connection succeeded.  : Connection failed.
Delete	Select a device in the Added device list and then click Delete button, system can disconnect the device and remove it from the Added device list.

Parameter	Function
Manual Add	<p>Click it, the interface is shown as in Figure 5-19. Here you can add network camera manually.</p> <p>You can select a channel from the dropdown list (Here only shows disconnection channel.)</p> <p>Note:</p> <ul style="list-style-type: none"> ● System supports manufactures such as Panasonic, Sony, Dynacolor, Samsung, AXIS, Arecont, and Onvif standard protocol. ● If you do not input IP address here. System uses default IP 192.168.0.0 and system does not connect to this IP. ● Can not add two devices at the same time. Click OK button here, system only connect to the corresponding device of current channel.

Change IP

On the searched devices list, check one or more device(s) at the same time. Click Modify IP button, you can see the following interface. See Figure 5-20

Please refer to the following sheet for log parameter information.

Parameter	Function
DHCP	Check the box here, system can auto allocate the IP address. The IP address, subnet mask, default gateway are reference only.
Static	Check the box here, you can set IP address, subnet mask, default gateway manually.
IP address/subnet mask/default gateway	You can input corresponding information here.
User name/password	The account you login the remote device. Please input here to password verification to change the remote device password.
Incremental value	When you want to change several IP addresses, once you input the IP address of the first device, the IP address of the next device will increase accordingly. For example, when the incremental value is 1, if the IP address of the first device is 172.10.3.128, the IP address of the second device will auto be set as 172.10.3.129.

Note

For the static IP address, system will alert you if there is any IP conflict. If you are changing several IP addresses at the same time, system auto skip the conflicted IP and auto allocate again according to the incremental value you set.

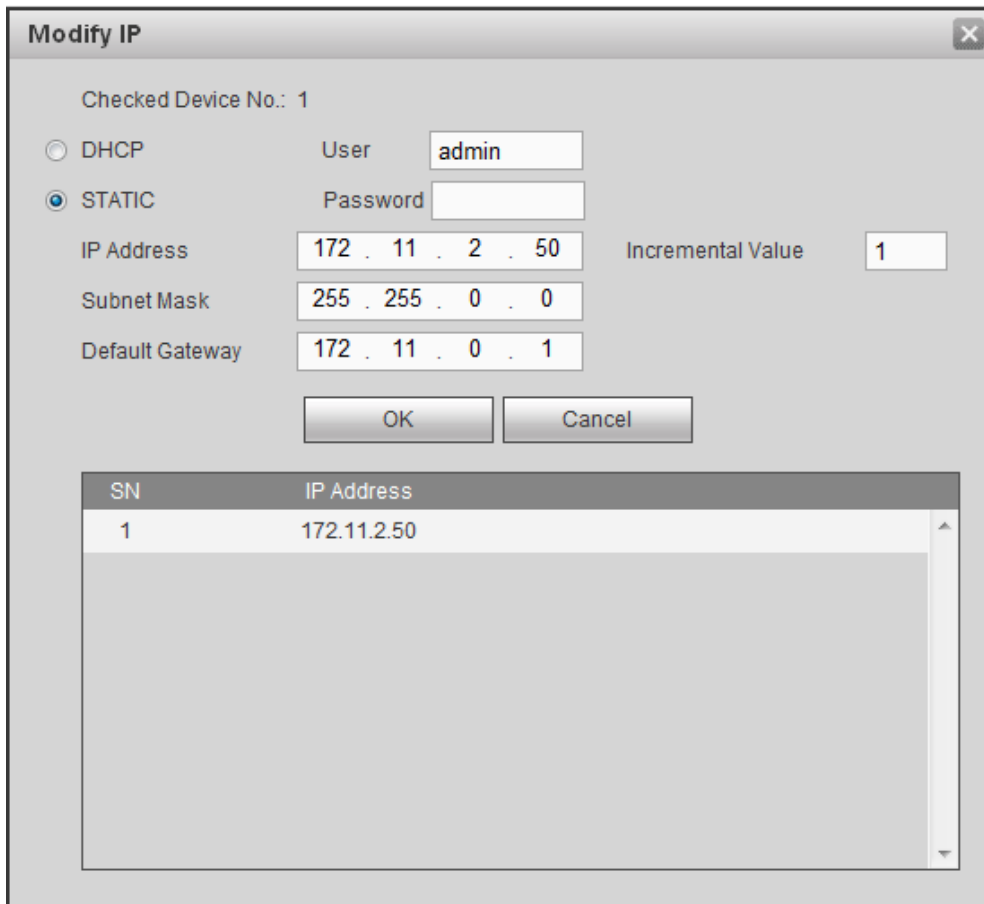

Figure 5-20

Export IP

You can export the list of the added devices to your local PC. Click Export button and then select the saved path. Click OK. You can see “Backup completed ” prompt.

Note

The export file extension name is .CVS. The file contains IP address, port, remote channel No. manufacturer, user name, password and etc.

Import IP

You can import the added device list to add the device conveniently. Click Import button, and then select the import file.

Note

If the imported IP is already in the added device list, system pops up dialogue box for you to confirm overwrite or not.

- Click OK button, the new IP setup can overwrite the old one.
- Click Cancel button, system adds the new IP setup.



Important

- You can edit the exported file. Please make sure the file format is the same. Otherwise you can not import the file again!
- System does not support customized protocol import/export.
- The import/export function is for the devices of the same language.

5.5.1.2 Conditions

From main window->Setup->Camera->Image, here you can view device property information. The setups become valid immediately after you set.

The analog channel is shown as in Figure 5-21.

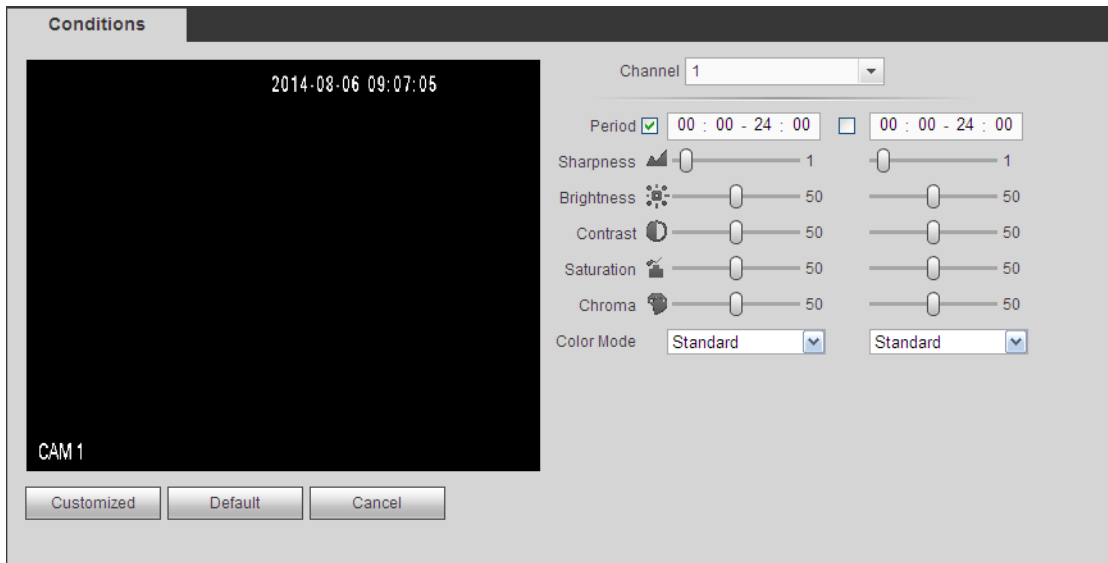

Figure 5-21

The digital channel is shown as in Figure 5-22.

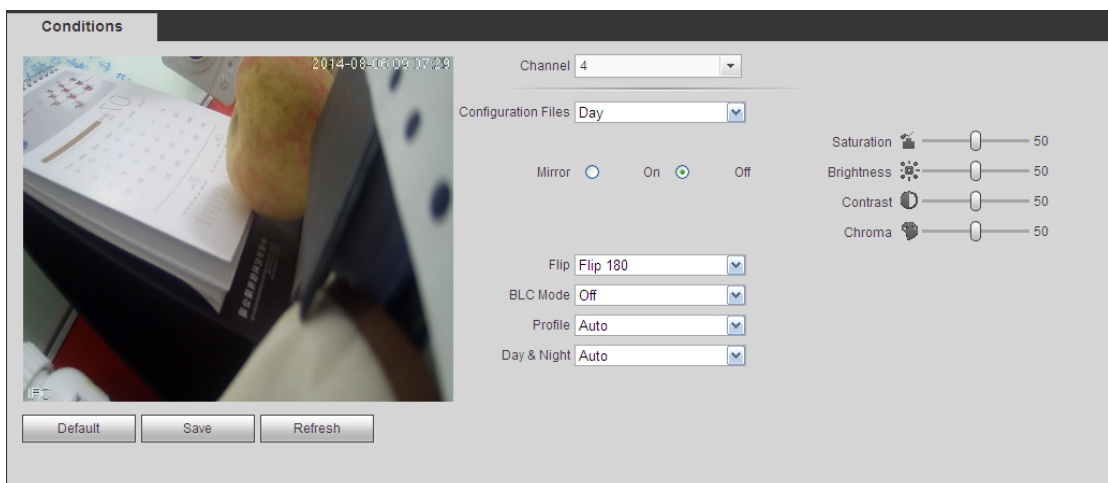

Figure 5-22

Please refer to the following sheet for detailed information.

Parameter	Function
Channel	Please select a channel from the dropdown list.

Period	It divides one day (24 hours) to two periods. You can set different hue, brightness, and contrast for different periods.
Hue	It is to adjust monitor video brightness and darkness level. The default value is 50. The bigger the value is, the large the contrast between the bright and dark section is and vice versa.
Brightness	It is to adjust monitor window brightness. The default value is 50. The larger the number is, the bright the video is. When you input the value here, the bright section and the dark section of the video will be adjusted accordingly. You can use this function when the whole video is too dark or too bright. Please note the video may become hazy if the value is too high. The value ranges from 0 to 100. The recommended value ranges from 40 to 60.
Contrast	It is to adjust monitor window contrast. The value ranges from 0 to 100. The default value is 50. The larger the number is, the higher the contrast is. You can use this function when the whole video bright is OK but the contrast is not proper. Please note the video may become hazy if the value is too low. If this value is too high, the dark section may lack brightness while the bright section may over exposure. The recommended value ranges from 40 to 60.
Saturation	It is to adjust monitor window saturation. The value ranges from 0 to 100. The default value is 50. The larger the number is, the strong the color is. This value has no effect on the general brightness of the whole video. The video color may become too strong if the value is too high. For the grey part of the video, the distortion may occur if the white balance is not accurate. Please note the video may not be attractive if the value is too low. The recommended value ranges from 40 to 60.
Color mode	It includes several modes such as standard, color. You can select corresponding color mode here, you can see hue, brightness, and contrast and etc will adjust accordingly.
Mirror	It is to switch video up and bottom limit. This function is disabled by default.
Flip	It is to switch video left and right limit. This function is disabled default. If you want to flip 90°, the resolution shall not be higher than 720P.
BLC	It includes several options: BLC/WDR/HLC/OFF. <ul style="list-style-type: none"> ● BLC: The device auto exposures according to the environments situation so that the darkest area of the video is cleared ● WDR: For the WDR scene, this function can lower the high bright section and enhance the brightness of the low bright section. So that you can view these two sections clearly at the same time. The value ranges from 1 to 100. When you

	<p>switch the camera from no-WDR mode to the WDR mode, system may lose several seconds record video.</p> <ul style="list-style-type: none"> ● HLC: After you enabled HLC function, the device can lower the brightness of the brightest section according to the HLC control level. It can reduce the area of the halo and lower the brightness of the whole video. ● OFF: It is to disable the BLC function. Please note this function is disabled by default.
Profile	<p>It is to set the white balance mode. It has effect on the general hue of the video. This function is on by default. You can select the different scene mode such as auto, sunny, cloudy, home, office, night, disable and etc to adjust the video to the best quality.</p> <ul style="list-style-type: none"> ● Auto: The auto white balance is on. System can auto compensate the color temperature to make sure the video color is proper. ● Sunny: The threshold of the white balance is in the sunny mode. ● Night: The threshold of the white balance is in the night mode. ● Customized: You can set the gain of the red/blue channel. The value ranges from 0 to 100.
Day/Night	<p>It is to set device color and the B/W mode switch. The default setup is auto.</p> <ul style="list-style-type: none"> ● Color: Device outputs the color video. ● Auto: Device auto select to output the color or the B/W video according to the device feature (The general bright of the video or there is IR light or not.) ● B/W: The device outputs the black and white video. ● Sensor: It is to set when there is peripheral connected IR light.

5.5.1.3 Encode

It includes encode setup, snapshot setup, video overlay and storage path setup.

5.5.1.3.1 Encode

From main window->Setup->Camera->Encode->Encode, the encode interface is shown as below. See Figure 5-23.

The screenshot shows the 'Encode' configuration window with the following settings:

- Channel:** 1
- Main Stream:**
 - Code-Stream Type: Regular
 - Compression: H.264H
 - Smart Codec: Stop
 - Resolution: 1920*1080(1080P)
 - Frame Rate(FPS): 15
 - Bit Rate Type: CBR
 - Bit Rate: 2048 Kb/S
 - Reference Bit Rate: 640-6144Kb/S
 - I Frame Interval: 1sec.
 - Audio Enable:
 - Audio Format: G711a
 - Audio Source: LOCAL
 - Watermark Enable:
- Sub Stream:**
 - Video Enable:
 - Compression: H.264H
 - Resolution: 352*288(CIF)
 - Frame Rate(FPS): 15
 - Bit Rate Type: CBR
 - Bit Rate: 320 Kb/S
 - Reference Bit Rate: 32-640Kb/S
 - I Frame Interval: 1sec.
 - Audio Enable:
 - Audio Format: G711a
 - Audio Source: LOCAL
 - Watermark String: (empty text box)

Buttons at the bottom: Copy, Save, Refresh, Default.

Figure 5-23

Please refer to the following sheet for detailed information.

Parameter	Function
Channel	Please select a channel from the dropdown list.
SVC	SVC is so called scaled video coding. Check the box to enable this function. During the network transmission process, system discards unimportant frames when the bandwidth is not sufficient or the decode capability is low. It is to guarantee video quality and transmission fluency.
Video enable	Check the box here to enable extra stream video. This item is enabled by default.
Code stream type	It includes main stream, motion stream and alarm stream. You can select different encode frame rates form different recorded events. System supports active control frame function (ACF). It allows you to record in different frame rates. For example, you can use high frame rate to record important events, record scheduled event in lower frame rate and it allows you to set different frame rates for motion detection record and alarm record.

Smart Codec	Select Start from the dropdown list to enable smart codec function. The DVR can auto reduce the video bit stream of the non-important surveillance object to save the storage space. Please note this function is for main stream only.
Compression	<p>Compression: System supports H.264H, H.264, H.264B, and MJPEG.</p> <ul style="list-style-type: none"> ◇ H.264H: It is the High Profile compression algorithm. It has the high encode compression rate. It can achieve high quality encode at low bit stream. Usually we recommend this type. ◇ H.264 is the general compression algorithm. ◇ H.264B is the Baseline algorithm. Its compression rate is low. For the same video quality, it has high bit stream requirements.
Resolution	It is to set video resolution. The higher the resolution is, the better the video quality is.
Frame Rate	PAL: 1~25f/s; NTSC: 1~30f/s.
Bit Rate	<ul style="list-style-type: none"> ● Main stream: You can set bit rate here to change video quality. The large the bit rate is, the better the quality is. Please refer to recommend bit rate for the detailed information. ● Extra stream: In CBR, the bit rate here is the max value. In dynamic video, system needs to low frame rate or video quality to guarantee the value. The value is null in VBR mode.
Reference bit rate	Recommended bit rate value according to the resolution and frame rate you have set.
I Frame	Here you can set the P frame amount between two I frames. The value ranges from 1 to 150. Default value is 50. Recommended value is frame rate *2.
Audio format	It includes G711a/G711u/PCM.
Audio source	Please select from the dropdown list. There are two options: Normal/HD AVS. In the normal mode, the audio signal comes from the Audio In. In the HD AVS mode, the audio signal comes from the coaxial cable of the camera.
Watermark enable	This function allows you to verify the video is tampered or not. Here you can select watermark bit stream, watermark mode and watermark character. Default character is DigitalCCTV. The max length is 85-digit. The character can only include number, character and underline.

5.5.1.3.2 Snapshot

From main window->Setup->Camera->Encode->Snapshot, the snapshot interface is shown as in Figure 5-24.

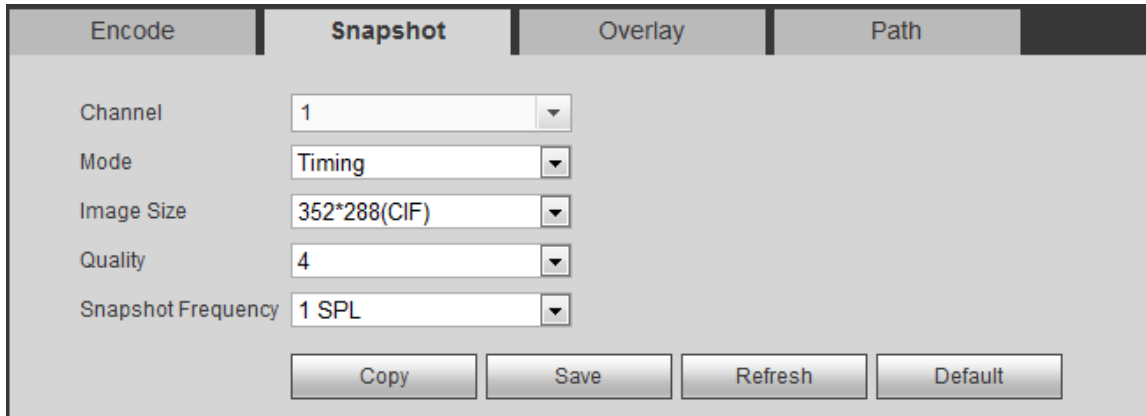

Figure 5-24

Please refer to the following sheet for detailed information.

Parameter	Function
Snapshot type	There are two modes: Regular (schedule) and Trigger. <ul style="list-style-type: none"> ● Regular snapshot is valid during the specified period you set. ● Trigger snapshot only is valid when motion detect alarm, tampering alarm or local activation alarm occurs.
Image size	It is the same with the resolution of the main stream.
Quality	It is to set the image quality. There are six levels.
Interval	It is to set snapshot frequency. The value ranges from 1s to 7s. Or you can set customized value. The max setup is 3600s/picture.
Copy	Click it; you can copy current channel setup to other channel(s).

5.5.1.3.3 Video Overlay

From main window->Setup->Camera->Encode->Overlay, the video overlay interface is shown as in Figure 5-25.

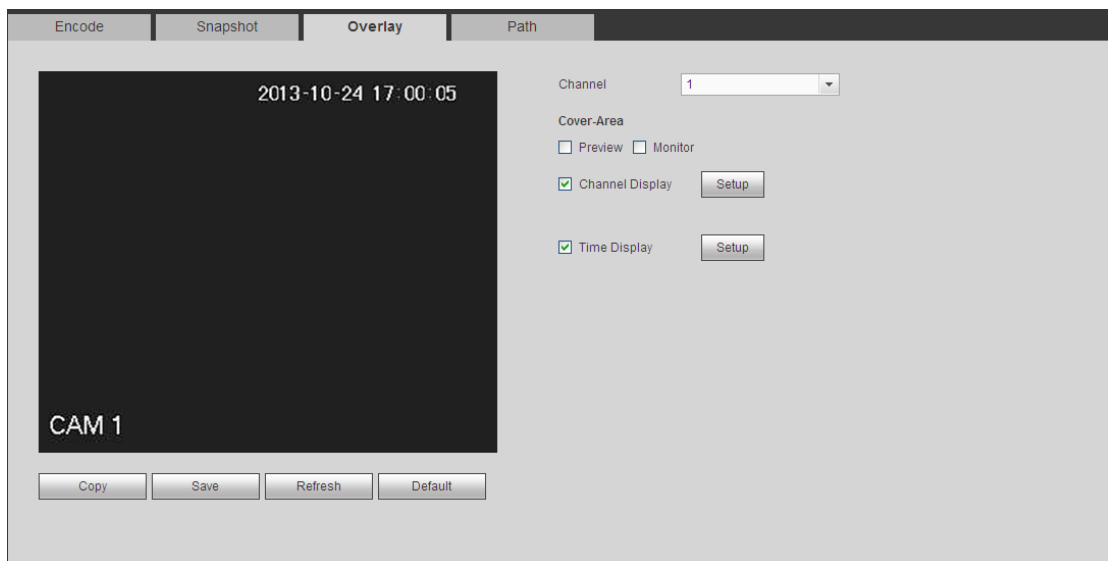



Figure 5-25

Please refer to the following sheet for detailed information.

Parameter	Function
Cover-area	Check Preview or Monitor first. Click Set button, you can privacy mask the specified video in the preview or monitor video. System max supports 4 privacy mask zones.
Time Title	You can enable this function so that system overlays time information in video window. You can use the mouse to drag the time title position. You can view time title on the live video of the WEB or the playback video.
Channel Title	You can enable this function so that system overlays channel information in video window. You can use the mouse to drag the channel title position. You can view channel title on the live video of the WEB or the playback video.

5.5.1.3.4 Path

From main window->Setup->Camera->Encode->Path, the storage path interface is shown as in Figure 5-26.

Here you can set snap image saved path ( in the preview interface) and the record storage path ( in the preview interface).The default setup is C:\PictureDownload and C:\RecordDownload.

Please click the Save button to save current setup.

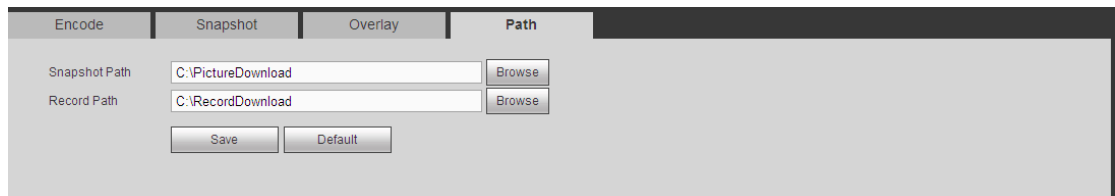

Figure 5-26

5.5.1.4 Channel Name

From main window->Setup->Camera->Camera name, here you can set channel name. See Figure 5-27.

Please note this function is for analog channel only. The offline digital channel name here is read-only.

Camera Name	
Channel 1	CAM 1
Channel 3	CAM 3
Channel 5	CAM 5
Channel 7	CAM 7
Channel 9	CAM 9
Channel 11	CAM 11
Channel 13	CAM 13
Channel 15	CAM 15
Channel 2	CAM 2
Channel 4	CAM 4
Channel 6	CAM 6
Channel 8	CAM 8
Channel 10	CAM 10
Channel 12	CAM 12
Channel 14	CAM 14
Channel 16	CAM 1

Figure 5-27

5.5.1.5 Channel Type

It is to set channel type. Each channel supports analog camera (analog standard definition/HD AVS) /network camera connection. Please note DVR needs to restart to activate new setup. The network camera connection shall begin with the last channel. For the 16-channel (or higher) series product, please go to the next page to set.

Note

If there is no connected channel, the channel type here just displays previous connection record. System supports self-adaptive after camera connection.

From main window->Setup->Camera->Channel type, you can go to the following interface. See Figure 5-28 (general series product) or Figure 5-29 (penta-brid series product).

- Auto: It supports self-adaptive function.
- AVS: It supports HD AVS signal input.
- AHD: It supports AHD signal input.
- CVBS: It support standard definition CVBS signal input.
- TVI: It supports TVI signal input.

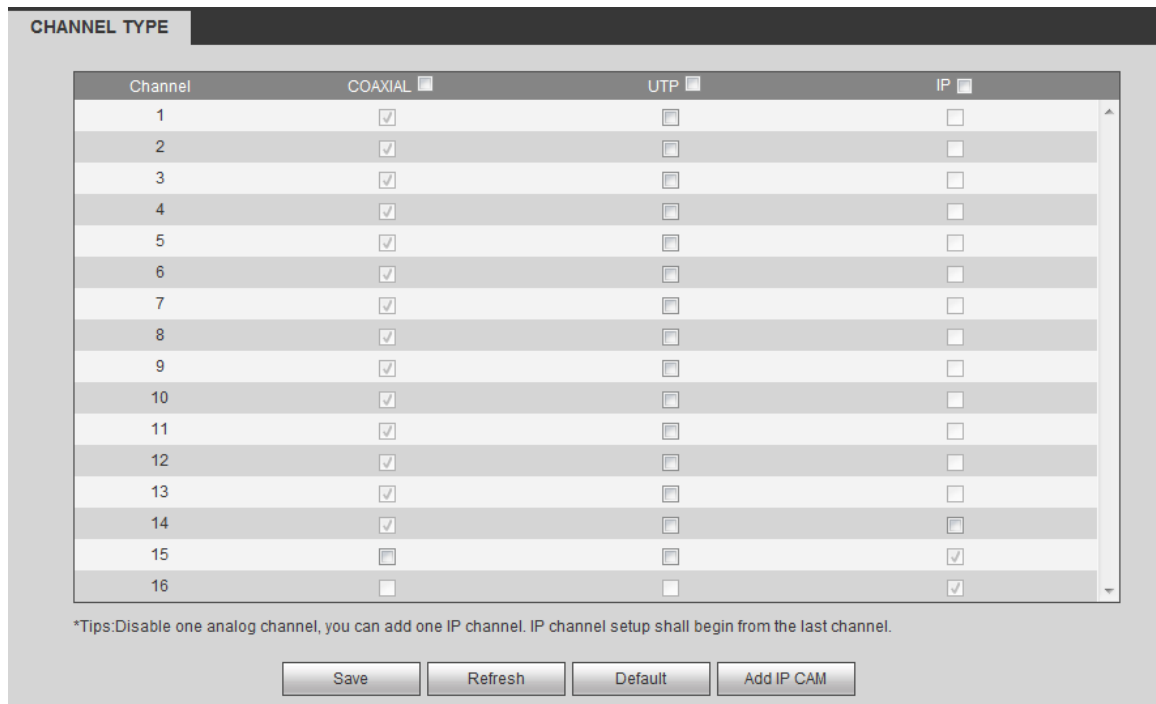

Figure 5-28

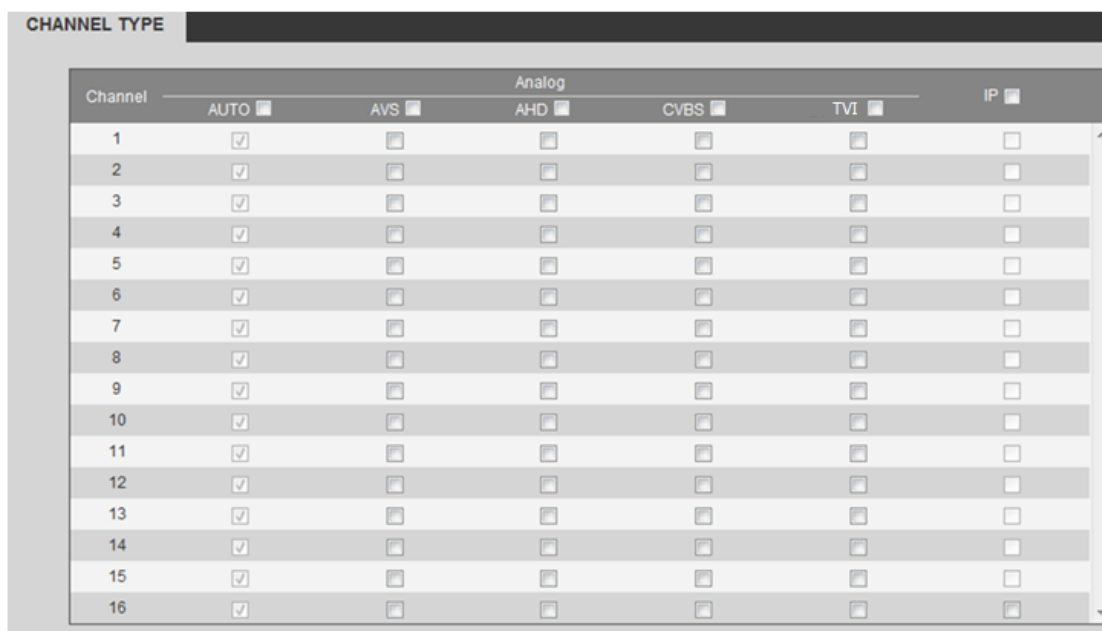

Figure 5-29

Important

Add/cancel IP CAM function is for some series product only.

- Add IP CAM: Click it; you can add corresponding X IP channels. Here X refers to the product channel amount. Please refer to Chapter 1.3 Specifications for IP channel amount information. System needs to restart to activate new setup.

For example, there is a 4-channel analog device, after the A/D switch, it can max supports 4 analog channels and 4 IP channels. Once it has become the 3+1 mode (3

analog channels+1 IP channel), you click  button, system becomes 3+5 mode (3 analog channels+5 IP channel).

- Cancel IP CAM: Click it, you can cancel IP channel. System needs to restart to restore original status.

5.5.2 Network

5.5.2.1 TCP/IP

Here is for you to set DVR IP address and DNS server so that it can connect with other devices in the LAN.

Before the operation, please check:

- If there is no router, please set the IP address of the same IP segment.
- If there is a router, please set corresponding gateway and subnet mask.

From main window->Setup->Network->TCP/IP, you can go to the following interface.

The single-Ethernet port interface is shown as in Figure 5-30.

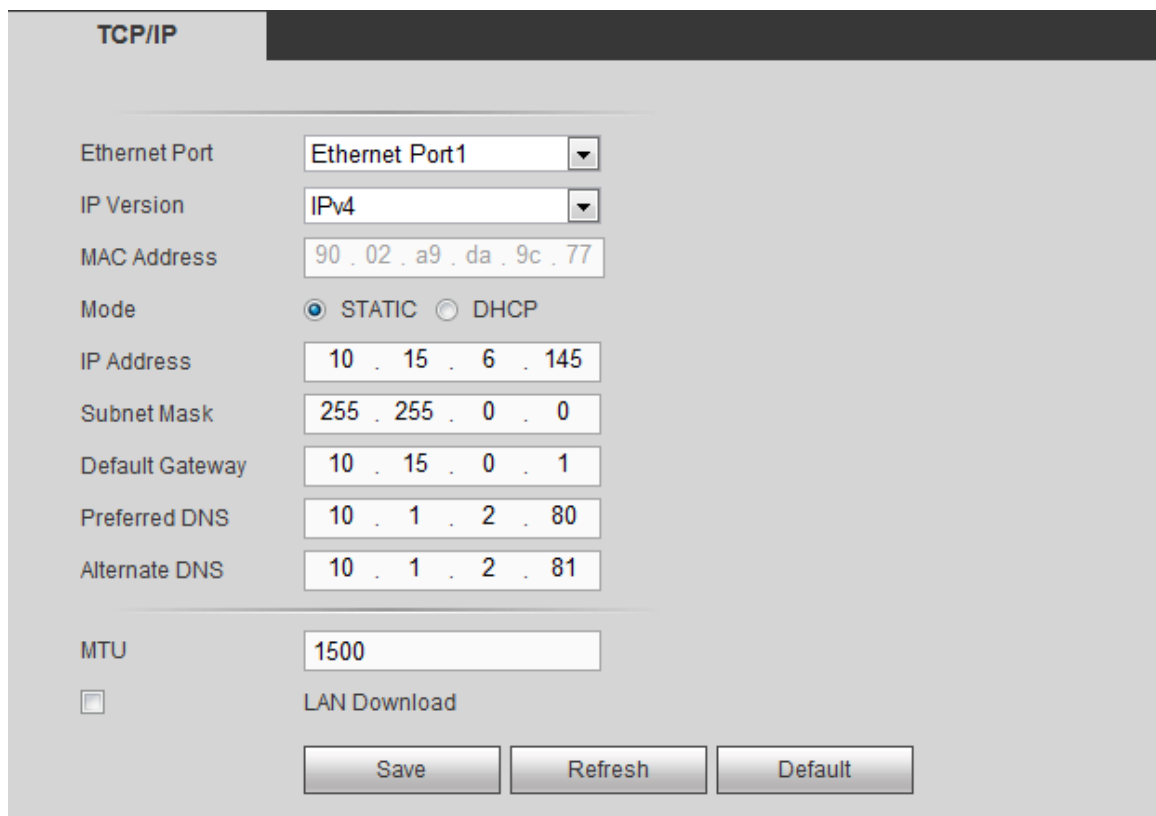

Figure 5-30

The dual-Ethernet port interface is shown as in Figure 5-31.

TCP/IP

Network Mode: Multi-address

Default Card: Ethernet Card1

Ethernet Card: Ethernet Card1

Mode: STATIC DHCP

MAC Address: 20 : 13 : 10 : 13 : 16 : 33

MTU: 1500

IP Version: IPv4

IP Address: 10 . 15 . 6 . 252

Subnet Mask: 255 . 255 . 0 . 0

Default Gateway: 10 . 15 . 0 . 1

Preferred DNS: 8 . 8 . 8 . 8

Alternate DNS: 8 . 8 . 4 . 4

LAN Download

Save Refresh Default

Figure 5-31

Please refer to the following sheet for detailed information.

Parameter	Function
Network mode	<p>It includes: single multiple-address, fault tolerance, load balance.</p> <ul style="list-style-type: none"> ● Multiple-address: eth1/eth2 operates separately. You can use the services such as HTTP, RTP service via eth1/eth2. Usually you need to set one default card (default setup is eth1) to request the auto network service from the device-end such as DHCP, email, FTP and etc. In multiple-address mode, system network status is shown as offline once one card is offline. ● Fault-tolerance: In this mode, device uses bond0 to communicate with the external devices. You can focus on one host IP address. At the same time, you need to set one master card. Usually there is only one running card (master card).System can enable alternate card when the master card is malfunction. The system is shown as offline once all cards are offline. Please note all cards shall be in the same LAN. ● Load balance: In this mode, device uses bond0 to communicate with the external device. The all cards are working now and bearing the network load. Their network load are general the same. The system is shown as offline once all cards are offline. Please note all cards shall be in the same LAN.

Mode	<p>There are two modes: static mode and the DHCP mode.</p> <ul style="list-style-type: none"> ● The IP/submask/gateway are null when you select the DHCP mode to auto search the IP. ● If you select the static mode, you need to set the IP/submask/gateway manually. ● If you select the DHCP mode, you can view the IP/submask/gateway from the DHCP. ● If you switch from the DHCP mode to the static mode, you need to reset the IP parameters. ● Besides, IP/submask/gateway and DHCP are read-only when the PPPoE dial is OK.
Mac Address	It is to display host Mac address.
IP Version	<p>It is to select IP version. IPV4 or IPV6.</p> <p>You can access the IP address of these two versions.</p>
IP Address	Please use the keyboard to input the corresponding number to modify the IP address and then set the corresponding subnet mask and the default gateway.
Preferred DNS	DNS IP address.
Alternate DNS	Alternate DNS IP address.
MTU	<p>It is to set MTU value of the network adapter. The value ranges from 1280-7200 bytes. The default setup is 1500 bytes.</p> <p>The following MTU value is for reference only.</p> <ul style="list-style-type: none"> ● 1500: Ethernet information packet max value and it is also the default value. It is the typical setup when there is no PPPoE or VPN. It is the default setup of some router, switch or the network adapter. ● 1492: Recommend value for PPPoE. ● 1468: Recommend value for DHCP. ● 1450: Recommended value for VPN.
For the IP address of IPv6 version, default gateway, preferred DNS and alternate DNS, the input value shall be 128-digit. It shall not be left in blank.	
LAN load	System can process the downloaded data first if you enable this function. The download speed is 1.5X or 2.0X of the normal speed.

5.5.2.2 Connection

5.5.2.2.1 Connection

Here you can set port connection amount and each port value.

From main window->Setup->Network->Connection->Connection, the connection interface is shown as in Figure 5-32.

CONNECTION		HTTPS
Max Connection	<input type="text" value="128"/>	(0~128)
TCP Port	<input type="text" value="37777"/>	(1025~65535)
UDP Port	<input type="text" value="37778"/>	(1025~65535)
HTTP Port	<input type="text" value="80"/>	(1~65535)
HTTPS Port	<input type="text" value="443"/>	(1~65535) <input type="checkbox"/> Enable
RTSP Port	<input type="text" value="554"/>	(1~65535)
POS Port	<input type="text" value="38800"/>	(1~65535)
RTSP Format	rtsp://<User Name>:<Password>@<IP Address>:<Port>/cam/realmonitor?channel=1&subtype=0 channel: Channel, 1-16; subtype: Code-Stream Type, Main Stream 0, Sub Stream 1.	
<input type="button" value="Save"/> <input type="button" value="Refresh"/> <input type="button" value="Default"/>		

Figure 5-32

Please refer to the following sheet for detailed information.

Parameter	Function
Max connection	It is the max Web connection for the same device. The value ranges from 1 to 120. The default setup is 120.
TCP port	The default value is 37777. You can input the actual port number if necessary.
UDP port	The default value is 37778. You can input the actual port number if necessary.
HTTP port	The default value is 80. You can input the actual port number if necessary.
HTTPS	The default value is 443. You can input the actual port number if necessary.
RTSP port	<ul style="list-style-type: none"> The default value is 554. Please leave it in blank if you are using default value. When you are using QuickTime or VLC, you can use the following format. BlackBerry cellphone support this function too. Real-time monitoring URL format: please require real-time RTSP media server, require channel number, and bit stream type in URL. You may need username and password. When you are using BlackBerry, please set encode mode as H.264B, resolution to CIF and turn off audio. URL format is: rtsp://username:password@ip:port/cam/realmonitor?channel=1&subtype=0 username/password/IP and port. <ul style="list-style-type: none"> Username: such as admin. Password: such as admin. IP: Device IP such as 10.7.8.122. Port: Port value. The default setup is 554. You can leave in blank if you are using default value.

	<ul style="list-style-type: none"> ● Channel: channel number. It starts with 1. If it is channel 2, then channel=2. ● Subtype: bit stream type. The main stream is 0(subtype=0), subtype is 1(subtype=1). <p>For example, if you want to get the substream of the channel 2, the URL is: <code>rtsp://admin:admin@10.12.4.84:554/cam/realmonitor?channel=2&subtype=1</code>.</p> <p>If there is no authentication, there is no need to specify user name and password, you can use the following format: <code>rtsp://ip:port/cam/realmonitor?channel=1&subtype=0</code></p>
POS port	The value ranges from 1 to 65535. The default setup is 38800.

5.5.2.2.2 HTTPS

Before you create certificate or download certificate, From main window->Setup->Network->Connection, set HTTPS port value and then check the box to enable HTTPS function.

From main window->Setup->Network->Connection,->HTTPS, in this interface, you can set to make sure the PC can successfully login via the HTTPS. It is to guarantee communication data security. The reliable and stable technology can secure the user information security and device safety. See Figure 5-33.

Note

- You need to implement server certificate again if you have changed device IP.
- You need to download root certificate if it is your first time to use HTTPS on current PC.

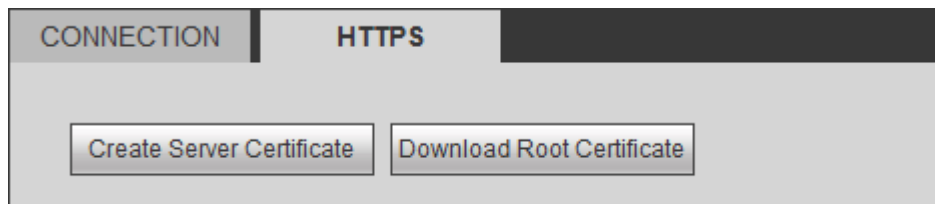
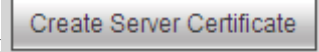

Figure 5-33

5.5.2.2.3 Create Server Certificate

If it is your first time to use this function, please follow the steps listed below.

In Figure 5-33, click  button, input country name, state name and etc. Click Create button. See Figure 5-34.

Note

Please make sure the IP or domain information is the same as your device IP or domain name.

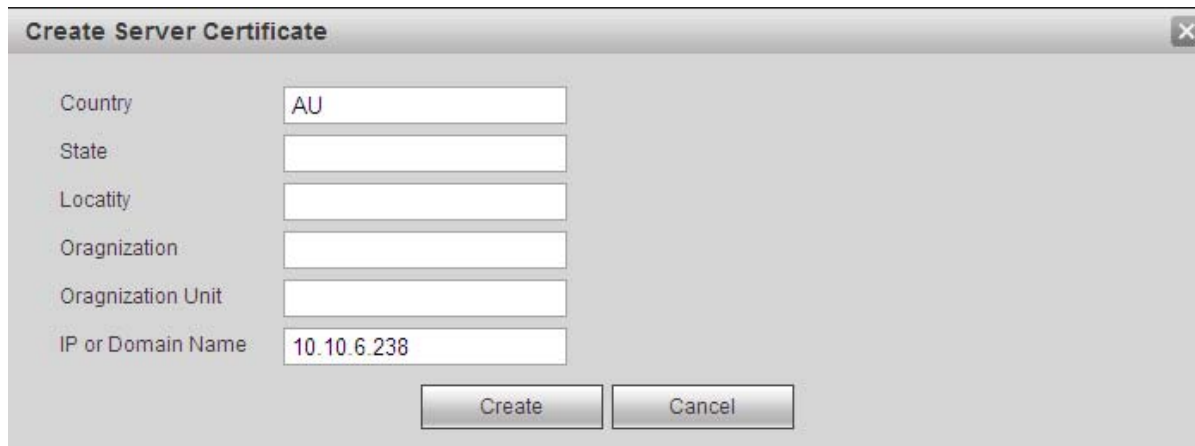

Figure 5-34

You can see the corresponding prompt. See Figure 5-35. Now the server certificate is successfully created.



Figure 5-35

5.5.2.2.4 Download root certificate

In Figure 5-33, click **Download Root Certificate** button, system pops up a dialogue box. See Figure 5-36.

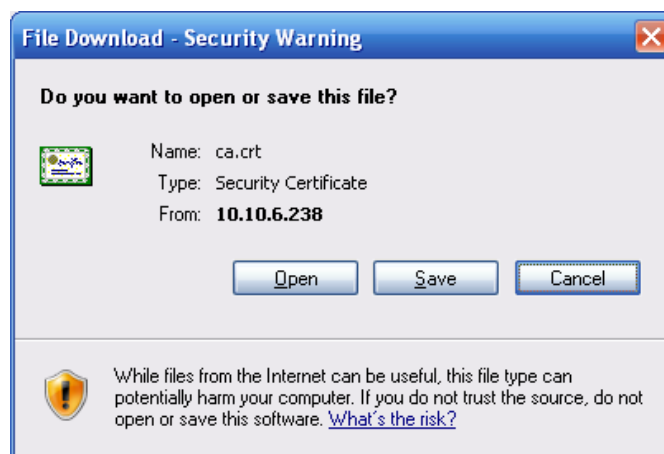

Figure 5-36

Click Open button, you can go to the following interface. See Figure 5-37.

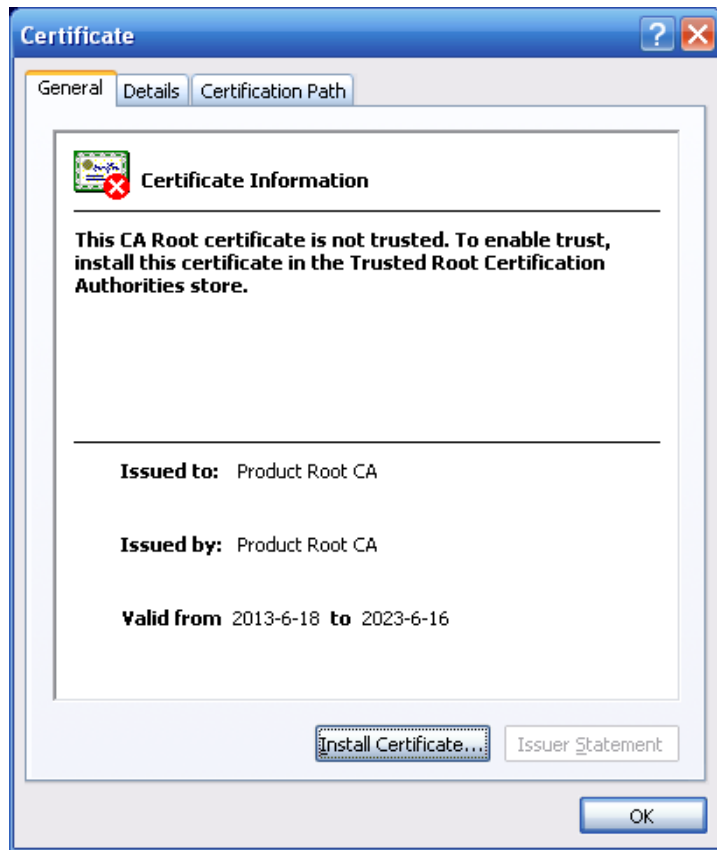

Figure 5-37

Click Install certificate button, you can go to certificate wizard. See Figure 5-38.



Figure 5-38

Click Next button to continue. Now you can select a location for the certificate. See Figure 5-39.

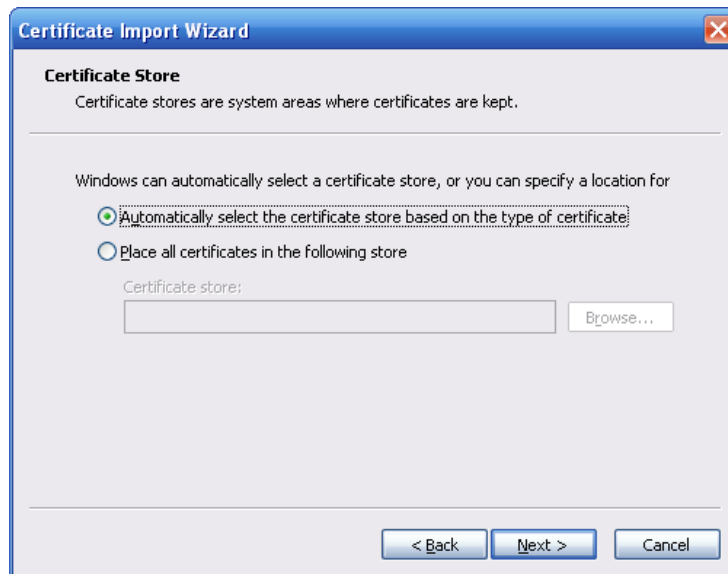

Figure 5-39

Click Next button, you can see the certificate import process is complete. See Figure 5-40.



Figure 5-40

Click Finish button, you can see system pops up a security warning dialogue box. See Figure 5-41.



Figure 5-41

Click Yes button, system pops up the following dialogue box, you can see the certificate download is complete. See Figure 5-42.



Figure 5-42

View and set HTTPS port

From Setup->Network->Connection, you can see the following interface. See Figure 5-43. You can see HTTPS default value is 443.

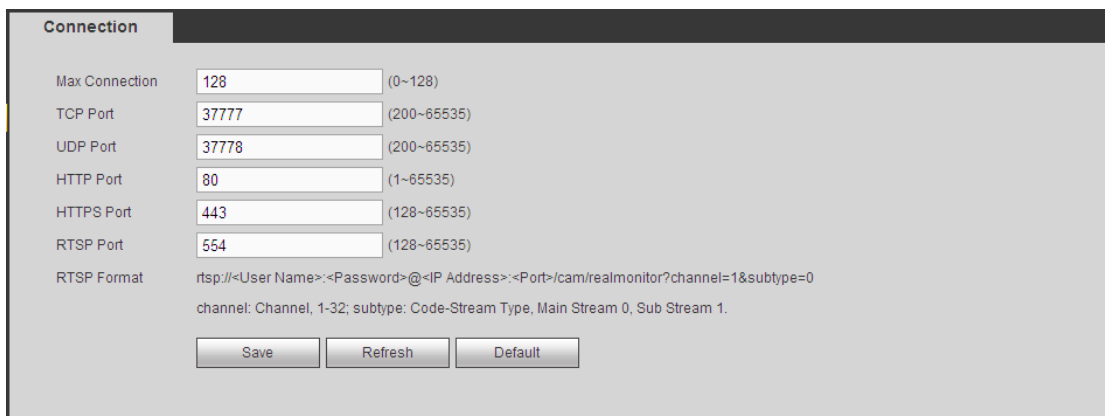

Figure 5-43

Login

Open the browser and then input <https://xx.xx.xx.xx:port>.

xx.xx.xx.xx: is your device IP or domain mane.

Port is your HTTPS port. If you are using default HTTPS value 443, you do not need to add port information here. You can input <https://xx.xx.xx.xx> to access.

Now you can see the login interface if your setup is right.

5.5.2.3 WIFI

Please note this function is for the device of WIFI module.

This function allows you to connect the DVR to the network via the WIFI.

From main window->Setup->Network->WIFI, the WIFI interface is shown as in Figure 5-44.

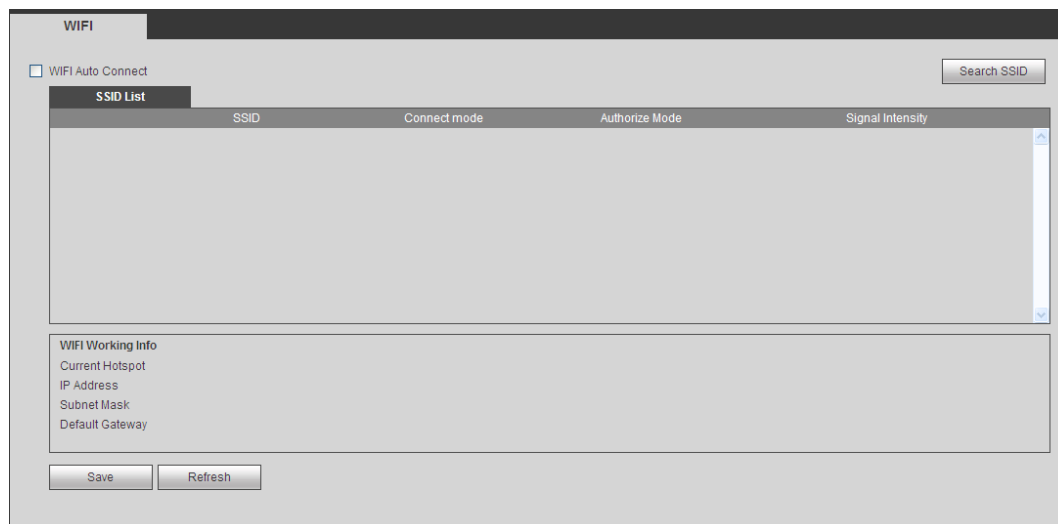

Figure 5-44

Please check the box to enable WIFI function and then click the Search SSID button. Now you can view all the wireless network information in the following list. Double click a name to connect to it. Click Refresh button, you can view latest connection status.

5.5.2.4 3G

CDMA/GPRS

From main window->Setup->Network->3G, the CDMA/GPRS interface is shown as in Figure 5-45.

Note

After you connected the 3G module, you can view the module information and wireless signal. If there is no information, click Search button to search.

Figure 5-45

Please refer to the following sheet for detailed information.

Parameter	Function
WLAN type	Here you can select 3G network type to distinguish the 3G module from different ISP. The types include WCDMA, CDMA1x and etc.
APN/Dial No.	Here is the important parameter of PPP.
Authorization	It includes PAP,CHAP,NO_AUTH.
Pulse interval	It is to set time to end 3G connection after you close extra stream monitor. For example, if you input 60 here, system ends 3G connection after you close extra stream monitor 60 seconds.
Important <ul style="list-style-type: none"> ◇ If the pulse interval is 0, then system does not end 3G connection after you close the extra stream monitor. ◇ Pulse interval here is for extra stream only. This item is null if you are using main stream to monitor. 	

Mobile

Before you set cellphone, please go to the previous chapter to enable Dial/SMS activate function.

From main window->Setup->Network->3G->Mobile, the mobile setup interface is shown as in Figure 5-46.

Here you can activate or turn off the 3G connected phone or mobile phone, or the phone you set to get alarm message.

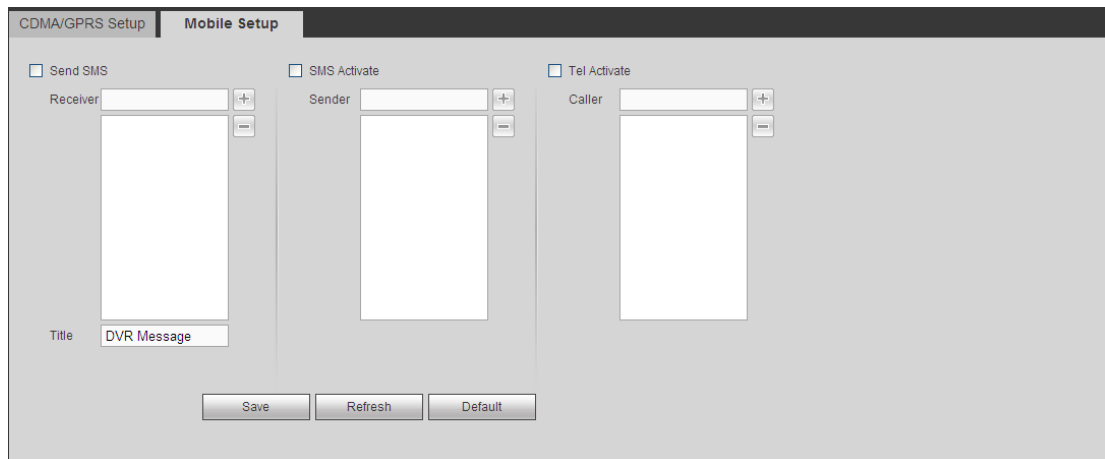



Figure 5-46

Check the box to enable send SMS/SMS activate/tel activate function.

Input sender/caller cellphone number and then click  to add the cellphone user to the list.

Select a number in the list and then click  to delete current number.

- Send SMS: Check the box to enable this function. Various kinds of alarm can trigger the DVR to send out alarm message to the receiver.
- SMS activate: Check the box to enable this function. The user can send out the message to the receiver to enable/disable 3G module.
- Telephone activate: Check the box to enable this function. The user can call the 3G user to enable/disable 3G module.

Click OK to complete the setup.

5.5.2.5 PPPoE

From main window->Setup->Network->PPPoE, the PPPoE interface is shown as in Figure 5-47.

Input the PPPoE user name and password you get from the IPS (internet service provider) and enable PPPoE function. Please save current setup and then reboot the device to get the setup activated.

Device connects to the internet via PPPoE after reboot. You can get the IP address in the WAN from the IP address column.

Please note, you need to use previous IP address in the LAN to login the device. Please go to the IP address item to view the device current device information. You can access the client-end via this new address.

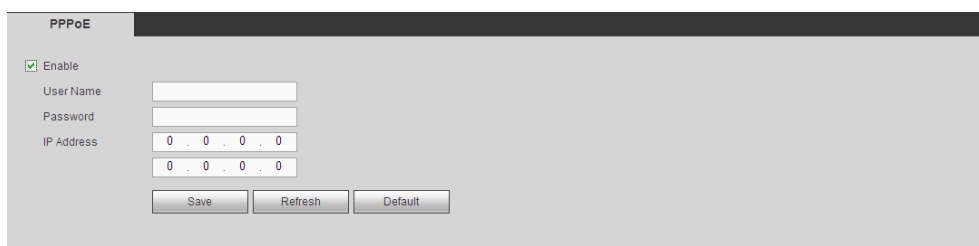

Figure 5-47

5.5.2.6 DDNS

From main window->Setup->Network->DDNS, the DDNS interface is shown as in Figure 5-48.

The DDNS is to set to connect the various servers so that you can access the system via the server. Please go to the corresponding service website to apply a domain name and then access the system via the domain. It works even your IP address has changed.

Please select DDNS from the dropdown list (Multiple choices). Before you use this function, please make sure your purchased device support current function.

Figure 5-48

Please refer to the following sheet for detailed information.

Parameter	Function
Server Type	You can select DDNS protocol from the dropdown list and then enable DDNS function.
Server IP	DDNS server IP address
Server Port	DDNS server port.
Domain Name	Your self-defined domain name.
User	The user name you input to log in the server.
Password	The password you input to log in the server.
Update period	Device sends out alive signal to the server regularly. You can set interval value between the device and DDNS server here.

Quick DDNS and Client-end Introduction

1) Background Introduction

Device IP is not fixed if you use ADSL to login the network. The DDNS function allows you to access the DVR via the registered domain name. Besides the general DDNS, the quick DDNS works with the device from the manufacturer so that it can add the extension function.

2) Function Introduction

The quick DDNS client has the same function as other DDNS client end. It realizes the bonding of the domain name and the IP address. Right now, current DDNS server is for our own devices only. You need to refresh the bonding relationship of the domain and the IP regularly. There is no user name, password or the ID registration on the server. At the same time, each device has a default domain name (Generated by MAC address) for your

option. You can also use customized valid domain name (has not registered.).

3) Operation

Before you use Quick DDNS, you need to enable this service and set proper server address, port value and domain name.

- Server address: www.quickddns.com
- Port number: 80
- Domain name: There are two modes: Default domain name and customized domain name.

Except default domain name registration, you can also use customized domain name (You can input your self-defined domain name.) After successful registration, you can use domain name to login installed of the device IP.

- User name: It is optional. You can input your commonly used email address.

Important

- Do not register frequently. The interval between two registrations shall be more than 60 seconds. Too many registration requests may result in server attack.
- System may take back the domain name that is idle for one year. You can get a notification email before the cancel operation if your email address setup is OK.

5.5.2.7 IP filter

IP Filter

From main window->Setup->Network->IP filter->IP filter, the IP filter interface is shown as in Figure 5-49.

After you enabled trusted sites function, only the IP listed below can access current DVR. If you enable blocked sites function, the following listed IP addresses can not access current DVR.

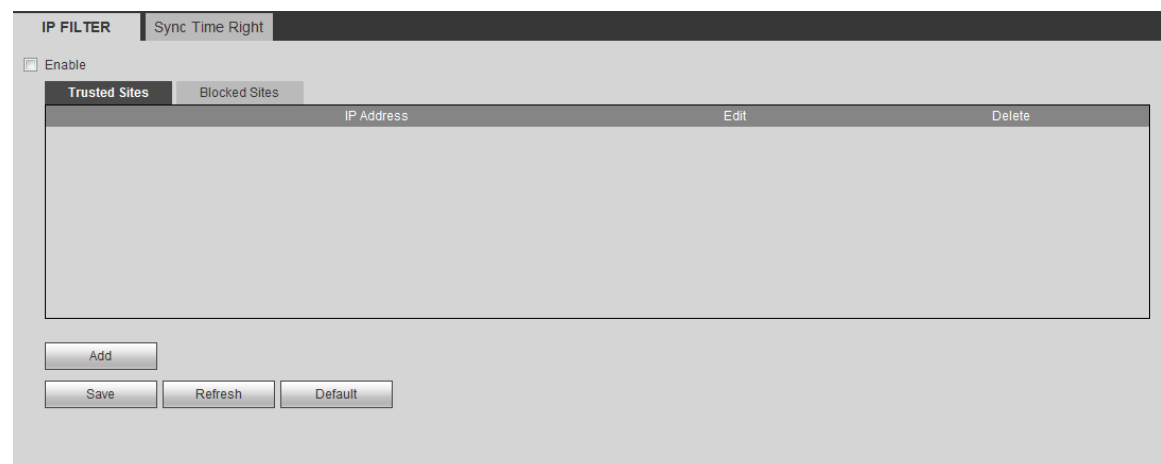

Figure 5-49

Please refer to the following sheet for detailed information.

Parameter	Function
IP address	Input the device IP address you want to add.
IP segment	Input the start address and end address of the IP segment you want to add.
IPv4	The IP address adopts IPv4 mode such as 172.16.5.10.
IPv6	The IP address adopts IPv6 mode such as aa:aa:aa:aa:aa:aa:aa:aa.
MAC address	Input the mac address you want to add. Note This function is for whitelist only.

Sync Time Right

From main window->Setup->Network->IP filter->Sync time right, the sync time interface is shown as Figure 5-50.

After you set sync time whitelist, only the specified IP address can sync or change device time. It is to avoid multiple hosts to sync or change time with the device at the same time. Please check the Enable box to enable this function and then click Add button to add the corresponding address, and then click Save button to complete the setup. From main menu->Setup->System->General->Date and time, change device time or check the IPC time sync box to enable time sync function.

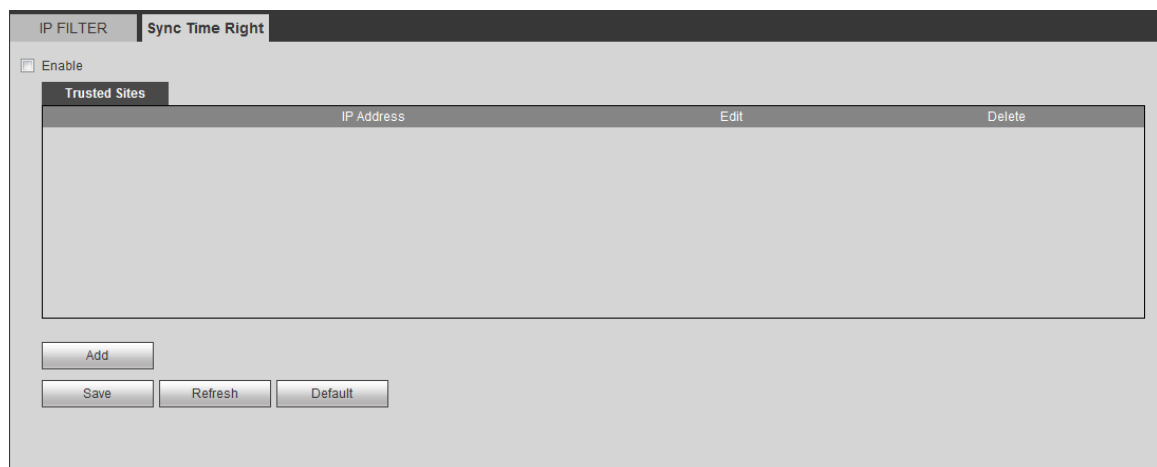

Figure 5-50

Please refer to the following sheet for detailed information.

Parameter	Function
IP address	Input the device IP address you want to add.
IP segment	Input the start address and end address of the IP segment you want to add.
IPv4	The IP address adopts IPv4 mode such as 172.16.5.10.
IPv6	The IP address adopts IPv6 mode such as aa:aa:aa:aa:aa:aa:aa:aa.

MAC address	Input the mac address you want to add.
-------------	--

5.5.2.8 Email

After you set email function, system can send out an email once there is an alarm, video detection event, abnormality event, intelligent event and etc.

From main window->Setup->Network->Email, the email interface is shown as in Figure 5-51.

Figure 5-51

Please refer to the following sheet for detailed information.

Parameter	Function
Enable	Please check the box here to enable email function.
SMTP Server	Input server address and then enable this function.
Port	Default value is 25. You can modify it if necessary.
Anonymity	For the server supports the anonymity function. You can auto login anonymously. You do not need to input the user name, password and the sender information.
User Name	The user name of the sender email account.
Password	The password of sender email account.
Sender	Sender email address.
Authentication (Encryption mode)	You can select SSL or none.
Subject	Input email subject here.
Attachment	System can send out the email of the snapshot picture once you check the box here.

Parameter	Function
Receiver	Input receiver email address here. Max three addresses. It supports SSL, TLS email box.
Interval	The send interval ranges from 0 to 3600 seconds. 0 means there is no interval. Please note system will not send out the email immediately when the alarm occurs. When the alarm, motion detection or the abnormality event activates the email, system sends out the email according to the interval you specified here. This function is very useful when there are too many emails activated by the abnormality events, which may result in heavy load for the email server.
Health mail enable	Please check the box here to enable this function.
Update period (interval)	This function allows the system to send out the test email to check the connection is OK or not. Please check the box to enable this function and then set the corresponding interval. System can send out the email regularly as you set here.
Email test	The system will automatically sent out a email once to test the connection is OK or not .Before the email test, please save the email setup information.

5.5.2.9 FTP

You need to download or buy FTP service tool (such as Ser-U FTP SERVER) to establish FTP service.

Please install Ser-U FTP SERVER first. From “start” -> “program” -> Serv-U FTP Server -> Serv-U Administrator. Now you can set user password and FTP folder. Please note you need to grant write right to FTP upload user.

From main window->Setup->Network->FTP, the FTP interface is shown as in Figure 5-52. It is to set FTP IP, port and etc for remote storage.

Figure 5-52

Please refer to the following sheet for detailed information.

Parameter	Function
Host IP	The host IP you have installed the FTP server.
Port	The default setup is 21.
User name/Password	The account for you to access the FTP server.
Remote directory	The folder you created under the root path of the FTP according to the corresponding rule. <ul style="list-style-type: none"> ● If there is no remote directory, system can auto create different directories according to the IP, time and channel. ● If there is remote directory, system can create corresponding folder under the FTP root path and then create different folders according to IP address, time and channel.
File length	File length is upload file length. When setup is larger than the actual file length, system will upload the whole file. When setup here is smaller than the actual file length, system only uploads the set length and auto ignore the left section. When interval value is 0, system uploads all corresponding files.
Image upload interval	It is the image upload interval. If the image upload interval is larger than the image snapshot frequency, system just uploads the lasted image. <ul style="list-style-type: none"> ● If the image interval is 5 seconds and the snapshot frequency is 2 seconds, system will send out the latest image at the buffer at 5 seconds. ● If the image upload interval is smaller than the snapshot frequency, system will upload at the snapshot frequency. For example, if the image interval is 5 seconds and the snapshot frequency is 10 seconds, system will send out the image at 10 seconds. ● From main menu->Setting->Camera->Encode->Snapshot to set snapshot frequency.
Channel	Select a channel from the dropdown list and then set week, period and record type.
Week day/Period	Please select from the dropdown list and for each day, you can set two periods.
Type	Please select uploaded record type (Alarm/intelligent/motion detect/regular). Please check the box to select upload type.

5.5.2.10 UPnP

It allows you to establish the mapping relationship between the LAN and the public network.

From main window->Setup->Network->UPnP, here you can also add, modify or remove UPnP item. See Figure 5-53.

- In the Windows OS, From Start->Control Panel->Add or remove programs. Click the “Add/Remove Windows Components” and then select the “Network Services” from the Windows Components Wizard.

- Click the Details button and then check the “Internet Gateway Device Discovery and Control client” and “UPnP User Interface”. Please click OK to begin installation.
- Enable UPnP from the Web. If your UPnP is enabled in the Windows OS, the DVR can auto detect it via the “My Network Places”

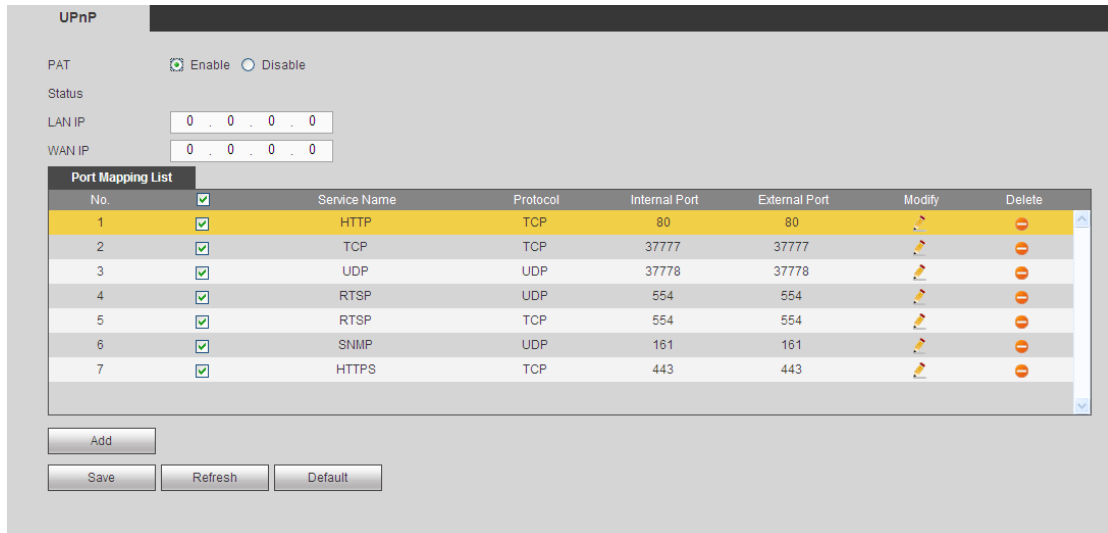



Figure 5-53

Please refer to the following sheet for detailed information.

Parameter	Function
Port enable/disable	Check the box to enable/disable this function.
LAN IP	It is the router IP in the LAN.
WAN IP	It is the router IP in the WAN.
Status	When the UPNP is offline, it shows as “Searching”. When the UPNP works it shows “Success”

Parameter	Function
Port mapping list	<p>It is the same information on the UPnP list of the router.</p> <ul style="list-style-type: none"> ● Service name: Defined by user. ● Protocol: Protocol type ● Internal port: Port that has been mapped in the router. ● External port: Port that has been mapped locally. <p>Note</p> <ul style="list-style-type: none"> ● When you are setting the router external port, please use 1024~5000 port. Do not use well-known port 1~255 and the system port 256~1023 to avoid conflict. ● When there are several devices in the same LAN, please arrange the port mapping properly in case several devices are mapping to the same external port. ● Please make sure the mapping port is available. ● For the TCP and UDP, please make sure the internal port and external port are the same to guarantee the proper data transmission.
Modify	Click  , you can change WAN port value.

5.5.2.11 SNMP

From main window->Setup->Network->SNMP, the SNMP interface is shown as in Figure 5-54.

The SNMP allows the communication between the network management work station software and the proxy of the managed device. It is reserved for the 3rd party to develop.



Figure 5-54

Please refer to the following sheet for detailed information.

Parameter	Function
SNMP Port	The listening port of the proxy program of the device. It is a UDP port not a TCP port. The value ranges from 1 to 65535. The default value is 161
Read Community	It is a string. It is a command between the manage process and the proxy process. It defined the authentication, access

Parameter	Function
	control and the management relationship between one proxy and one group of the managers. Please make sure the device and the proxy are the same. The read community will read all the objects the SNMP supported in the specified name. The default setup is public.
Write Community	It is a string. It is a command between the manage process and the proxy process. It defined the authentication, access control and the management relationship between one proxy and one group of the managers. Please make sure the device and the proxy are the same. The read community will read/write/access all the objects the SNMP supported in the specified name. The default setup is write.
Trap address	The destination address of the Trap information from the proxy program of the device.
Trap port	The destination port of the Trap information from the proxy program of the device. It is for the gateway device and the client-end PC in the LAN to exchange the information. It is a non-protocol connection port. It has no effect on the network applications. It is a UDP port not TCP port. The value ranges from 1 to 165535. The default value is 162.
SNMP version	<ul style="list-style-type: none"> ● Check V1, system only processes the information of V1. ● Check V2, system only processes the information of V2.

- In Figure 5-54., check the box to enable the SNMP function. Input the IP address of the PC than is running the software in the Trap address. You can use default setup for the rest items.
- Compile the above mentioned two MIB file via the software MIB Builder.
- Run MG-SOFT MIB Browser to load the file from the previous step to the software.
- Input the device IP you want to manage in the MG-SOFT MIB Browser. Please set the corresponding version for your future reference.
- Open the tree list on the MG-SOFT MIB Browser; you can get the device configuration. Here you can see the device has how many video channels, audio channels, application version and etc.

5.5.2.12 Multicast

From main window->Setup->Network->Multicast, the multicast interface is shown as in Figure 5-55.

Multicast is a transmission mode of data packet. When there is multiple-host to receive the same data packet, multiple-cast is the best option to reduce the broad width and the CPU load. The source host can just send out one data to transit. This function also depends on the relationship of the group member and group of the router.

Figure 5-55

Please refer to the following sheet for detailed information.

Parameter	Function
IP address	The multicast IP address (0.0.0.0~255.255.255.255).
Port	The multicast port value(1025~65000).

Use WEB to login, you can see the following interface. See Figure 5-56. Select login type as the Multicast from the dropdown list. After you logged in the Web, the Web can automatically get multiple cast address and add it to the multiple cast groups. You can enable real-time monitor function to view the video.

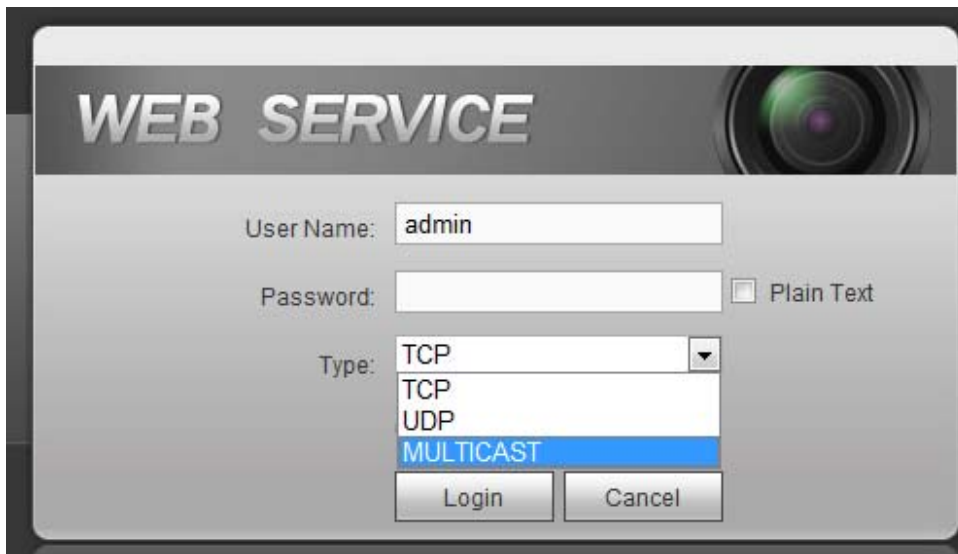

Figure 5-56

5.5.2.13 Auto Register

From main window->Setup->Network->Register, the auto register interface is shown as below. See Figure 5-57.

This function allows the device to auto register to the proxy you specified. In this way, you can use the client-end to access the DVR and etc via the proxy. Here the proxy has a switch function. In the network service, device supports the server address of IPv4 or domain.

Please follow the steps listed below to use this function.

Please set proxy server address, port, and sub-device name at the device-end. Please enable the auto register function, the device can auto register to the proxy server.

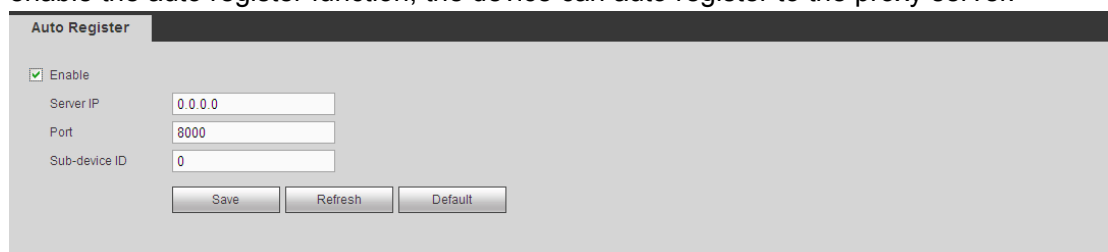

Figure 5-57

Please refer to the following sheet for detailed information.

Parameter	Function
Server IP address	The server IP address or server domain name you want to register.
Port	The auto registration port value of the server.
Sub-device ID	The device ID allocated by the server.

5.5.2.14 Alarm Centre

From main window->Setup->Network->Alarm centre, the alarm centre interface is shown as below. See Figure 5-58.

System can upload alarm signal to the alarm center when an alarm occurs.

Before you use alarm center, please set server IP, port and etc. When an alarm occurs, system can send out data as the protocol defined, so the client-end can get the data.

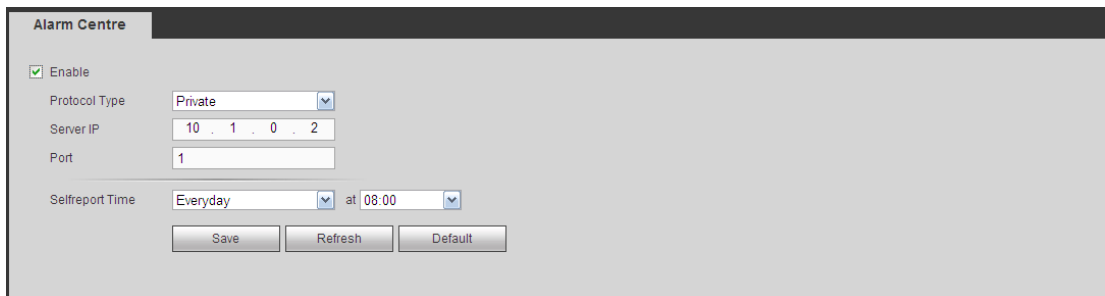

Figure 5-58

Please refer to the following sheet for detailed information.

Parameter	Function
Enable	Check the box to enable alarm center function.
Server IP	The IP address and the communication port of the PC that has installed the alarm client.
Port	
Self-report time	Select alarm upload time from the dropdown list.

5.5.2.15 P2P

You can use cellphone client or the management platform to access the device.

- You can use your cell phone to scan the QR code and add it to the cell phone client.
- Via the SN from scanning the QR code, you can access the device in the WAN.

Please refer to the P2P operation manual included in the resources CD.

From main menu->Setup->Network->P2P, the P2P interface is shown as in Figure 5-59.

Check the Enable box to enable P2P function and then click the Save button. Now you can view the device status and SN.





Figure 5-59

Here we use cell phone APP to continue.

- Step 1 Use cell phone to scan the QR code and download the APP.
- Step 2 After installation, run the APP and Live Preview, enter the main interface. Now you can add device to the APP.



1. Open App; tap  to go to the Live preview.
2. Tap  at the top left corner, you can see the main menu.
3. Tap Device manager button, you can use several modes (P2P/DDNS/IP and etc) to add the device. Click  to save current setup. Tap Start Live preview to view all-channel video from the connected device. See Figure 5-60.

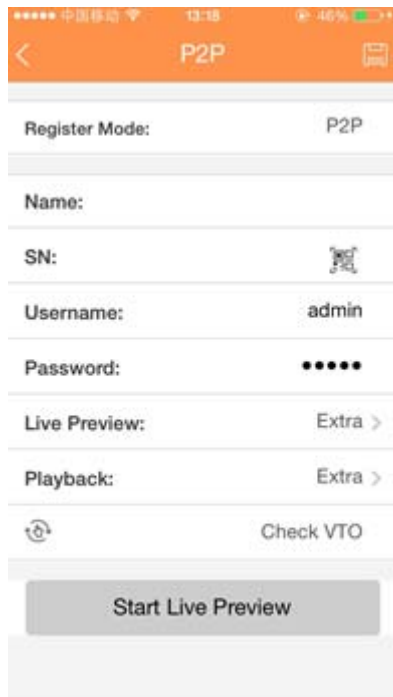

Figure 5-60

5.5.3 Event



Important

For the channel connected to the analog fisheye, the intelligent function is null. Please refer to the interface of your purchased product for detailed information.

5.5.3.1 Video detect

The video detect includes motion detect, video loss, tampering, scene change and diagnosis.

5.5.3.1.1 Motion Detect

From main window->Setup->Event->Video detect->Motion detect, the motion detect interface is shown as in Figure 5-61.

Motion Detect | Video Loss | Tampering | Scene Change | Diagnosis

Enable 1

Period

Anti-Dither 5 sec.(0-600)

Region

Record Channel

Delay 10 sec.(10~300)

Alarm Out 1 2 3 4 5 6

Latch 10 sec.(0~300)

PTZ Activation

Tour

Snapshot

Video Matrix

Voice Prompts File Name None

Show Message Send Email Alarm Upload Buzzer

Message Log

Figure 5-61

Setup [X]

Thursday [v]

<input checked="" type="checkbox"/>	00 : 00	-	24 : 00
<input type="checkbox"/>	00 : 00	-	24 : 00
<input type="checkbox"/>	00 : 00	-	24 : 00
<input type="checkbox"/>	00 : 00	-	24 : 00
<input type="checkbox"/>	00 : 00	-	24 : 00
<input type="checkbox"/>	00 : 00	-	24 : 00

Figure 5-62

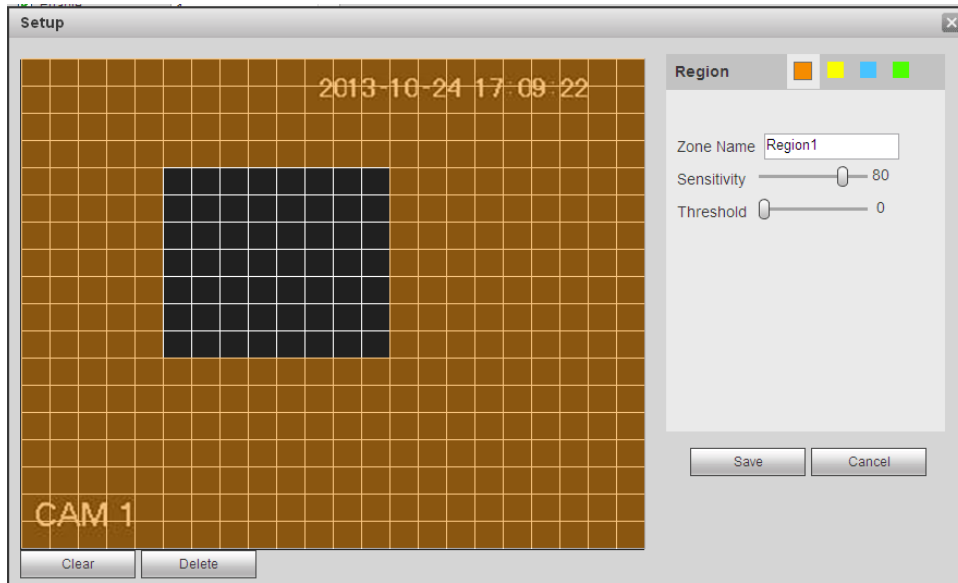

Figure 5-63

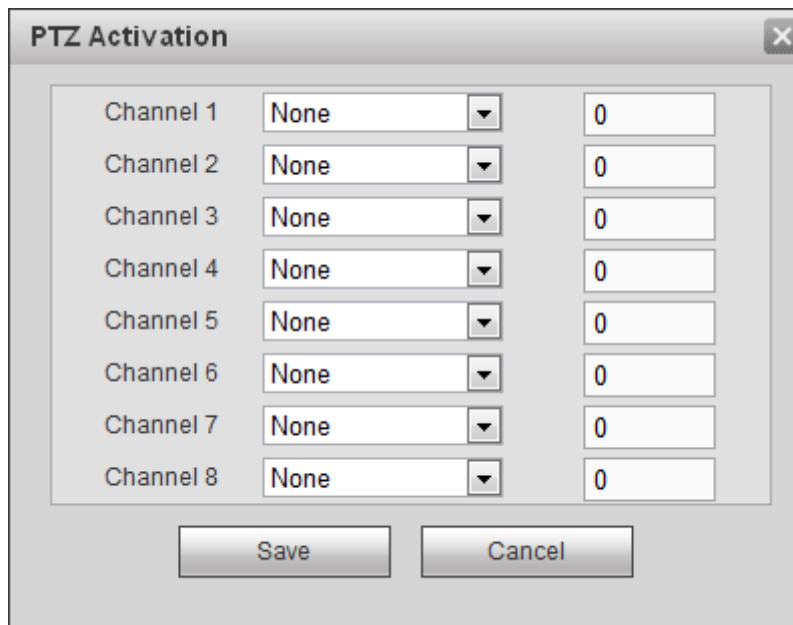

Figure 5-64

Please refer to the following sheet for detailed information.

Parameter	Function
Enable	You need to check the box to enable motion detection function. Please select a channel from the dropdown list.
Period	Motion detection function becomes activated in the specified periods. See Figure 5-62. There are six periods in one day. Please draw a circle to enable corresponding period. Click OK button, system goes back to motion detection interface, please click save button to exit.

Parameter	Function
Anti-Dither	System only memorizes one event during the anti-dither period. The value ranges from 5s to 600s.
Sensitivity	There are six levels. The sixth level has the highest sensitivity.
Region	If you select motion detection type, you can click this button to set motion detection zone. The interface is shown as in Figure 5-63. Here you can set motion detection zone. There are four zones for you to set. Please select a zone first and then left drag the mouse to select a zone. The corresponding color zone displays different detection zone. You can click Fn button to switch between the arm mode and disarm mode. In arm mode, you can click the direction buttons to move the green rectangle to set the motion detection zone. After you completed the setup, please click ENTER button to exit current setup. Do remember click save button to save current setup. If you click ESC button to exit the region setup interface system will not save your zone setup.
Record channel	System auto activates motion detection channel(s) to record once an alarm occurs. Please note you need to set motion detect record period and go to Storage-> Schedule to set current channel as schedule record.
Record Delay	System can delay the record for specified time after alarm ended. The value ranges from 10s to 300s.
Alarm out	Enable alarm activation function. You need to select alarm output port so that system can activate corresponding alarm device when an alarm occurs.
Latch	System can delay the alarm output for specified time after an alarm ended. The value ranges from 1s to 300s.
Video Matrix	Check the box here to enable this function. When an alarm occurs, VIDEO OUTPUT port displays device video output. It displays video (1-window tour) from alarm activation channel you select at the Record channel interface. It has high priority than the tour setup in Main menu->Setting->System->Video matrix. Please note this function is for some series product only.
Snapshot	You need to check the box here to enable this function. You can set corresponding channel to snapshot when motion detect alarm occurs.
Show message	System can pop up a message to alarm you in the local host screen if you enabled this function.
Buzzer	Check the box here to enable this function. The buzzer beeps when an alarm occurs.
Alarm upload	System can upload the alarm signal to the centre (Including alarm centre).
Message	When 3G network connection is OK, system can send out a message when motion detect occurs.
Send Email	If you enabled this function, System can send out an email to alert you when an alarm occurs.

Tour	You need to check the box here to enable this function. System begins 1-window or multiple-window tour display among the channel(s) you set to record when an alarm occurs.
PTZ Activation	Here you can set PTZ movement when alarm occurs. Such as go to preset X. See Figure 5-64.
Log	Check the box here, system can record motion detect event log.

5.5.3.1.2 Video Loss

The video loss interface is shown as in Figure 5-65.

After analysis video, system can generate a video loss alarm when the detected moving signal reached the sensitivity you set here.

Please note video loss does not support anti-dither, sensitivity, region setup. For rest setups, please refer to chapter 5.5.3.1.1 motion detect for detailed information.

Figure 5-65

5.5.3.1.3 Tampering

The tampering interface is shown as in Figure 5-66.

After analysis video, system can generate a tampering alarm when the detected moving signal reached the sensitivity you set here.

For detailed setups, please refer to chapter 5.5.3.1.1 motion detect for detailed information.

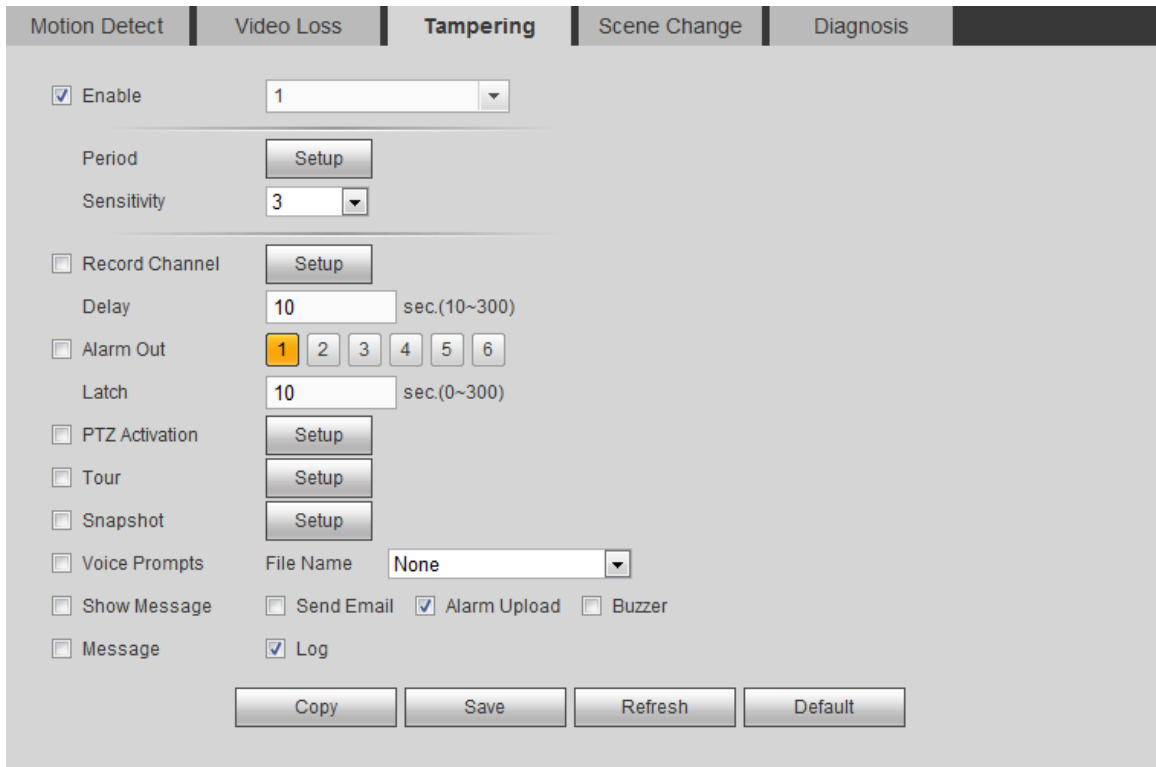

Figure 5-66

5.5.3.1.4 Scene change

From main window->Setup->Event->Video detect->Scene change, the video diagnosis interface is shown as in Figure 5-67.

For detailed setups, please refer to chapter 5.5.3.1.1 motion detect for detailed information.

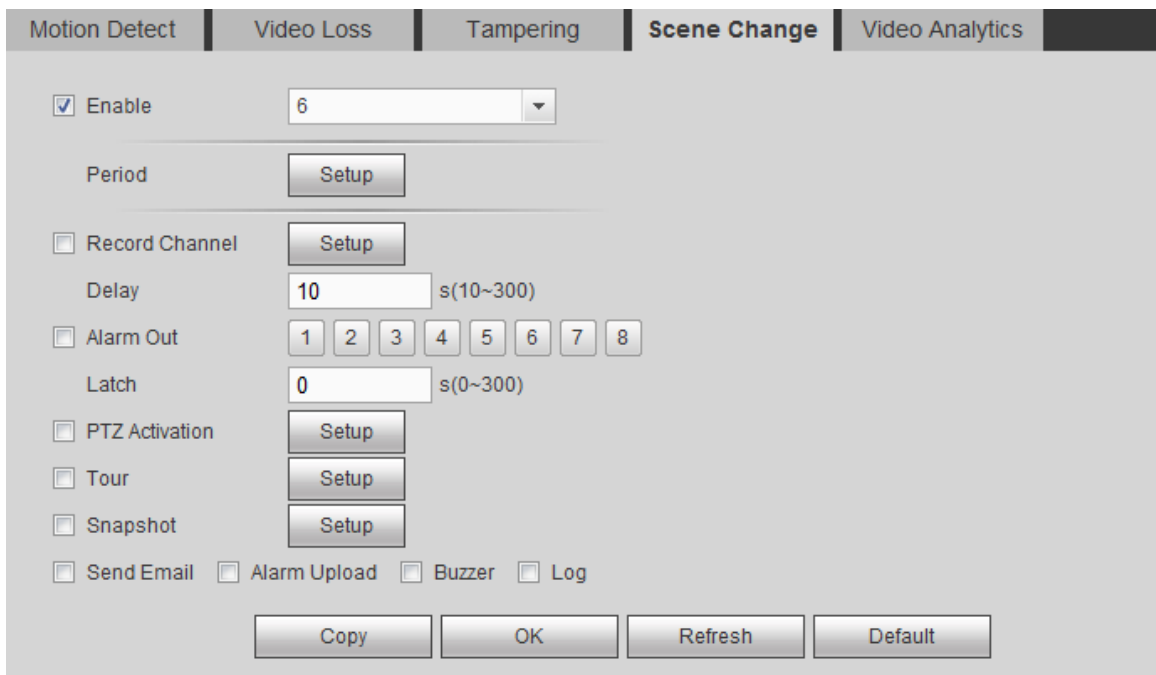

Figure 5-67

5.5.3.1.5 Diagnosis

Note

Please make sure you purchased network camera supports this function.

System can trigger an alarm when the video stripe, noise, color cast, out of focus, over exposure event occurred. See Figure 5-68.

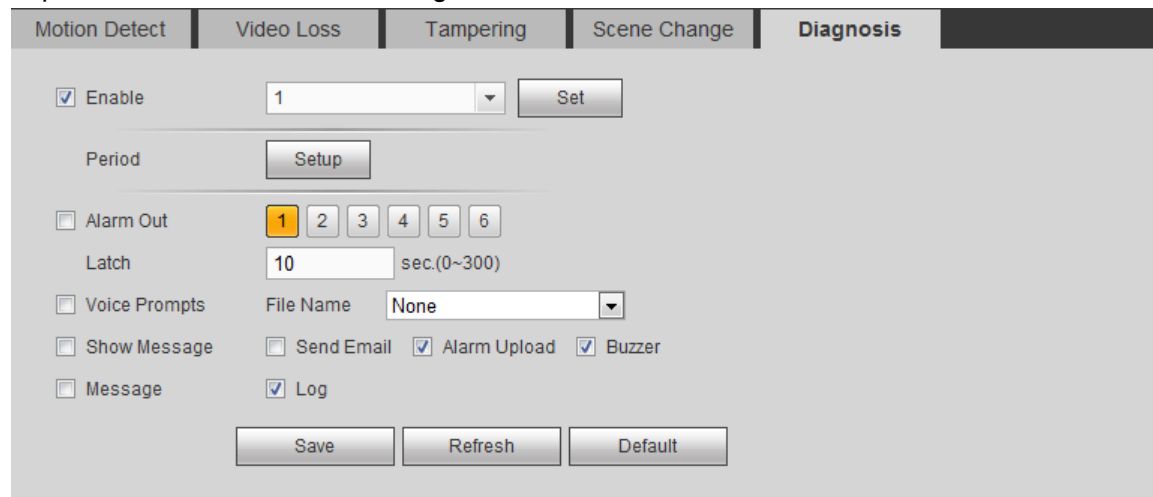

Figure 5-68

Click Set button, you can check the corresponding box to select diagnosis type. See Figure 5-69.

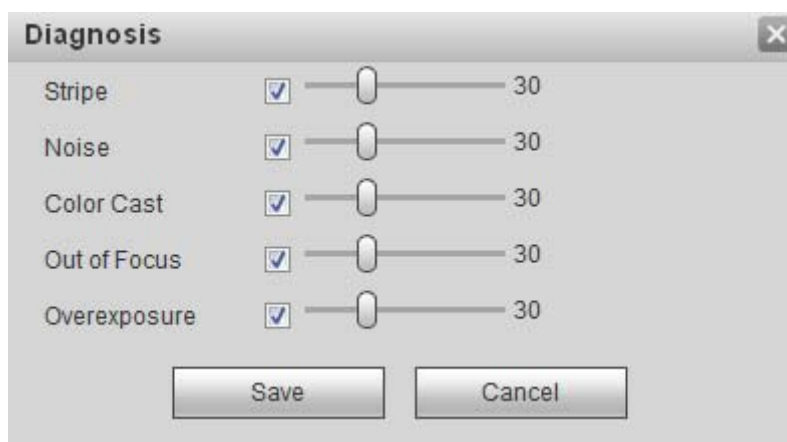

Figure 5-69

Note

Video diagnosis alarm can trigger PTZ preset, tour, and pattern.

For detailed setups, please refer to chapter 5.5.3.1.1 motion detect for detailed information.

5.5.3.2 Smart Plan (Optional)

Important

- The smart plan is for the smart network camera. If you do not set a rule here, you can not use the intelligent functions in IVS (Chapter 5.5.3.3), Face detection (Chapter 5.5.3.4) and People counting (Chapter 5.5.3.5) when you are connecting to a smart network camera.
- The IVS, human face detection, and people counting channel amount shall not

be over 6.

From main menu->Setup->Event->Smart plan, you can go to the smart plan interface. See Figure 5-70.

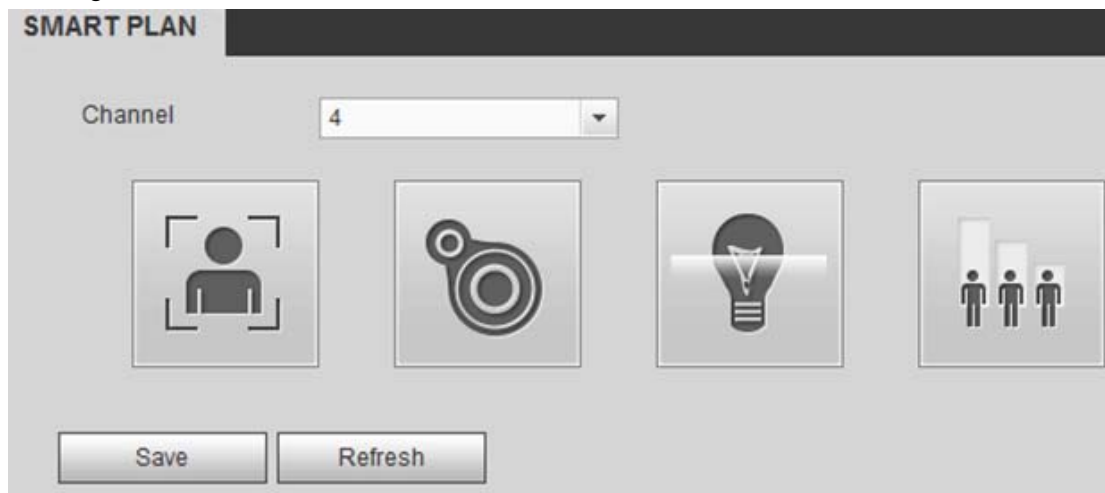

Figure 5-70

Select a channel from the dropdown list. Click Add button, you can see an interface shown as below.

Select a channel from the dropdown list and then set preset. Click Add button and then set the corresponding rule.

Click OK button to complete the setup.

5.5.3.3 IVS (Optional)



Right now, the IVS function max supports 10 rules.

Once any object violate the rule, the DVR can trigger an alarm and alert you as the specified alarm mode.

From main menu->Setup->Event->IVS->Tripwire, you can see the following interface. Here you can set behavior analytics rule. See Figure 5-71.

Please follow the steps listed below.

- 1) Please select a channel from the dropdown list.
- 2) Click  and then select corresponding rule.
- 3) Set rule type and set corresponding parameters.
- 4) Check the box to enable the rule.
- 5) Click OK button to save current setup.

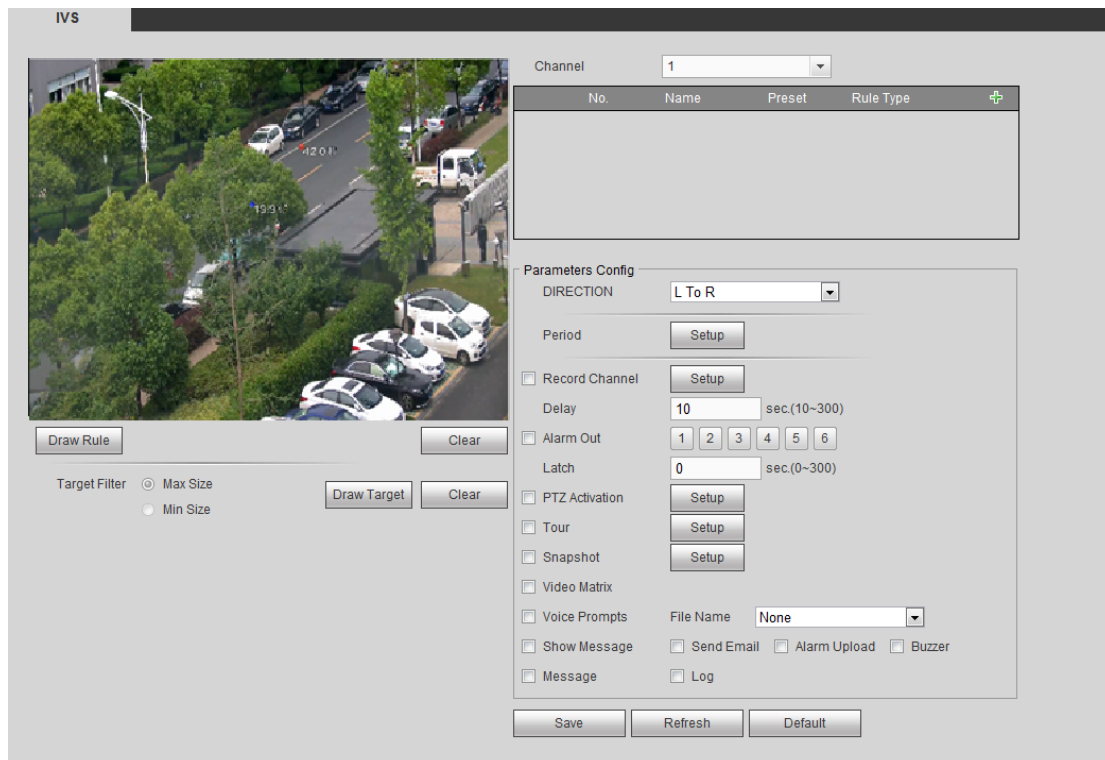



Figure 5-71

5.5.3.3.1 Tripwire

System generates an alarm once there is any object crossing the tripwire in the specified direction. Please use according to your actual situation.

Note:

- The tripwire function is valid once your connected network camera or your DVR supports this function.
- If you want to use the IVS function of the network camera, please make sure your connected network camera supports this function.

From main menu->Setup->Event->IVS->Tripwire, click  to add the rule and select the rule type as Tripwire; check the Tripwire box to enable tripwire function. You can see the following interface. See Figure 5-72.

Tips

Double click to change the rule name.

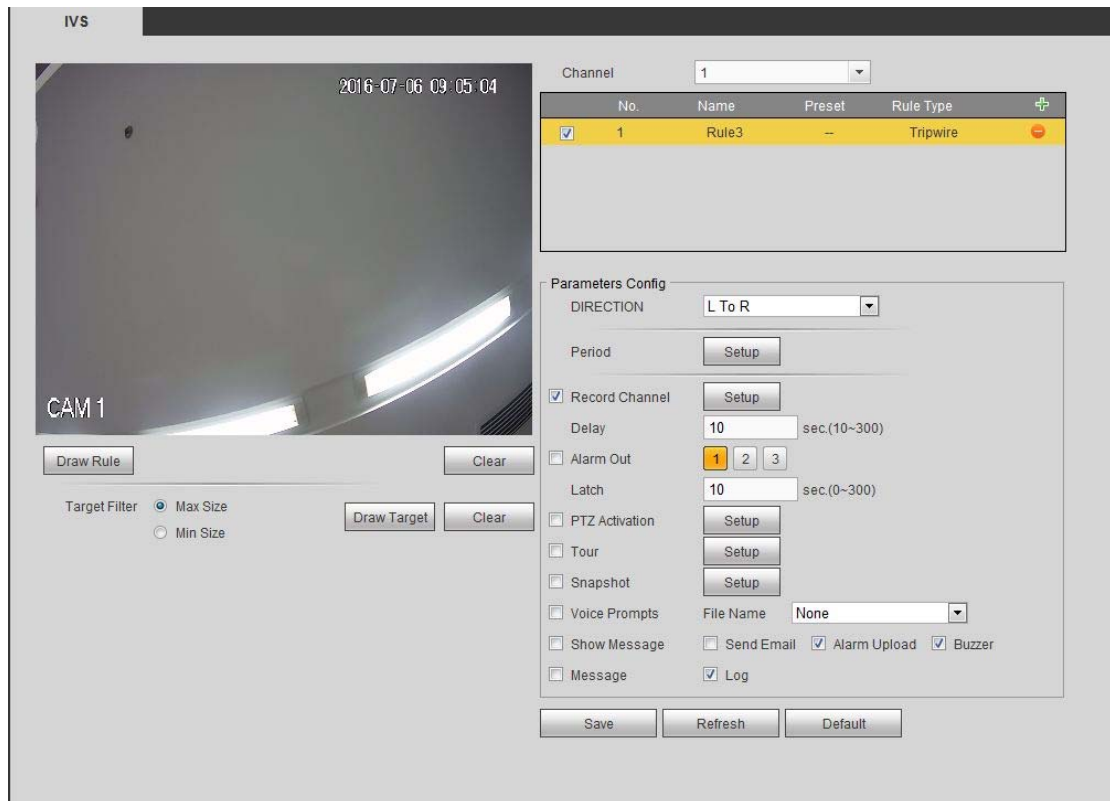

Figure 5-72

- Direction: There are three options: L->R, R->L, both. System can generate an alarm once there is any object crossing in the specified direction.

Now you can draw a rule. Click Draw rule button and then left click mouse to draw a tripwire. The tripwire can be a direct line, curve or polygon. Right click mouse to complete. See Figure 5-73.

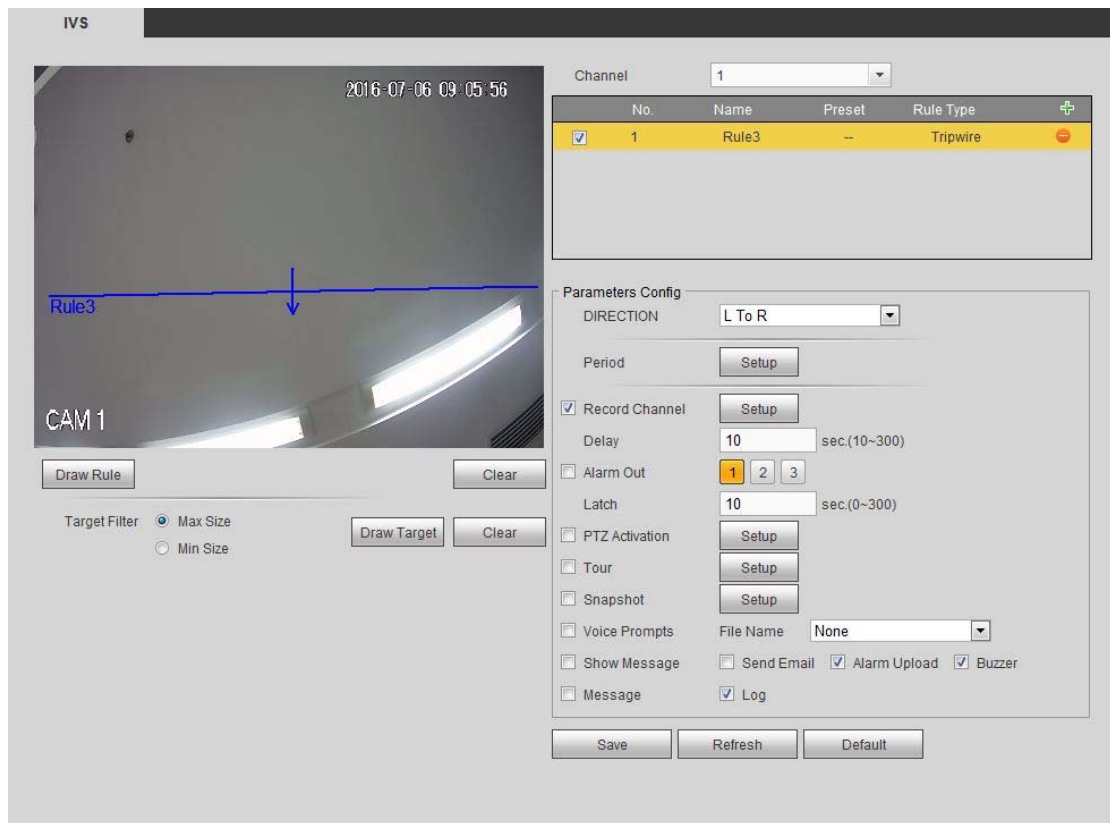

Figure 5-73

Click **Draw Target** to draw filter object. See Figure 5-132.

Select the blue line and then use mouse to adjust zone size.

Note

- Each rule can set two sizes (min size/max size). Once the object is smaller than the min size or larger than the max size, there is no alarm. Please make sure the max size is larger than the min size.
- The default max size is the full screen, you can select the blue line and then use mouse to adjust.
- Click Clear to clear the zone you are drawing.

Click Ok to complete the rule setup.

For detailed setups, please refer to chapter 5.5.3.1.1 motion detect for detailed information.

5.5.3.3.2 Intrusion (Cross warning zone)

This function is to detect there is any object enter or exit the zone. Please use according to your actual situation.

Note:

- The intrusion function is valid once your network camera or your DVR supports this function.
- For the DVR, different series products support different channel amount. For 16-channel series product or lower, it supports 4 channels. For 24/32-channel or

16+16 hybrid series product, there is only 1 channel supports this function.

- If you want to use the IVS function of the network camera, please make sure your connected network camera supports this function.

From main menu->Setup->Event->IVS->Intrusion, the intrusion interface is shown as below. See Figure 5-74.

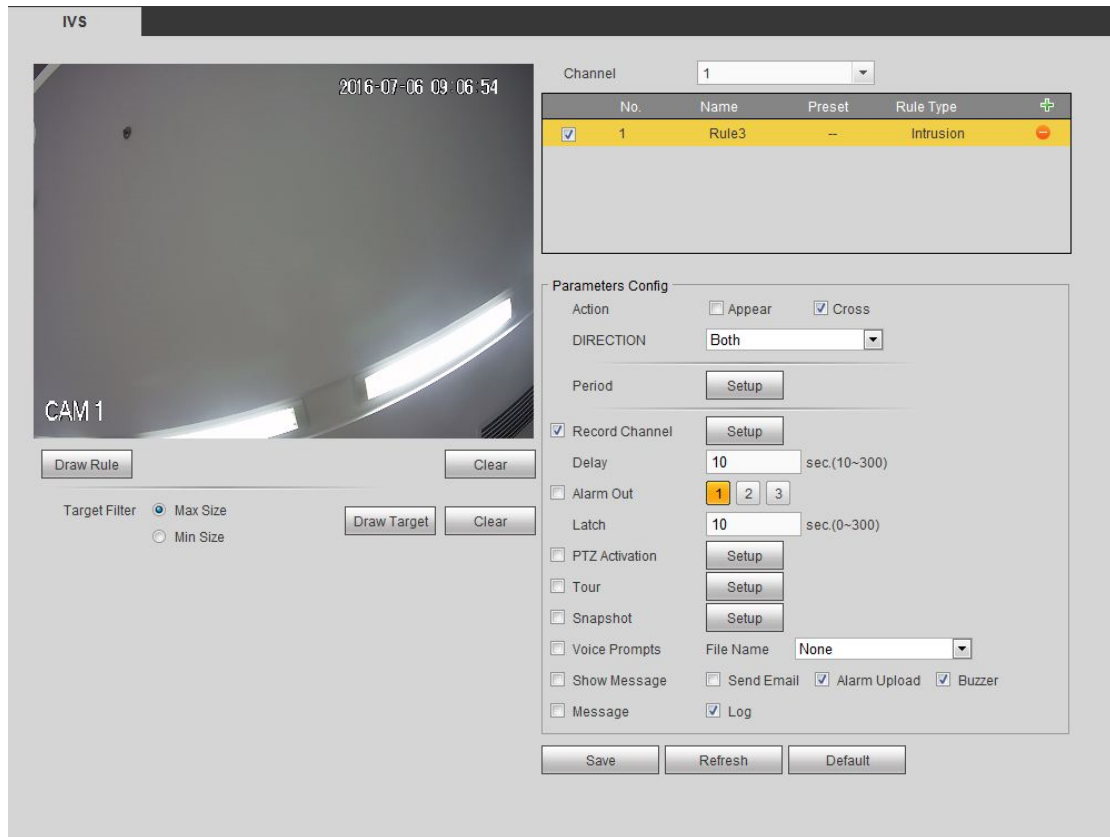



Figure 5-74

Click  to add the rule and select the rule type as Intrusion, check the Intrusion box to enable intrusion function.

Tips

Double click to change the rule name.

- Action: It is to set intrusion mode.
 - ✧ Cross: It includes enter the warning zone, leave the warning zone or cross the warning zone.
 - ✧ Appear: An object falling from nowhere (such as from the sky). It may not fully enter the warning zone.
- Direction: When the action mode is cross, there are three options: A->B, B->A, both. System can generate an alarm once there is any object enter/exit (Or both) the zone.

Now you can draw a rule. Left click mouse to draw a line first and then right click mouse to draw another line until you draw a rectangle, you can right click mouse to exit.

Click  to draw filter object. Select the blue line and then use mouse to adjust

zone size.

Note

- Each rule can set two sizes (min size/max size). Once the object is smaller than the min size or larger than the max size, there is no alarm. Please make sure the max size is larger than the min size.
- The default max size is the full screen, you can select the blue line and then use mouse to adjust.
- Click Clear to clear the zone you are drawing.

Click Ok to complete the rule setup.

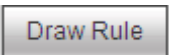
Click  to draw the zone. See Figure 5-75.

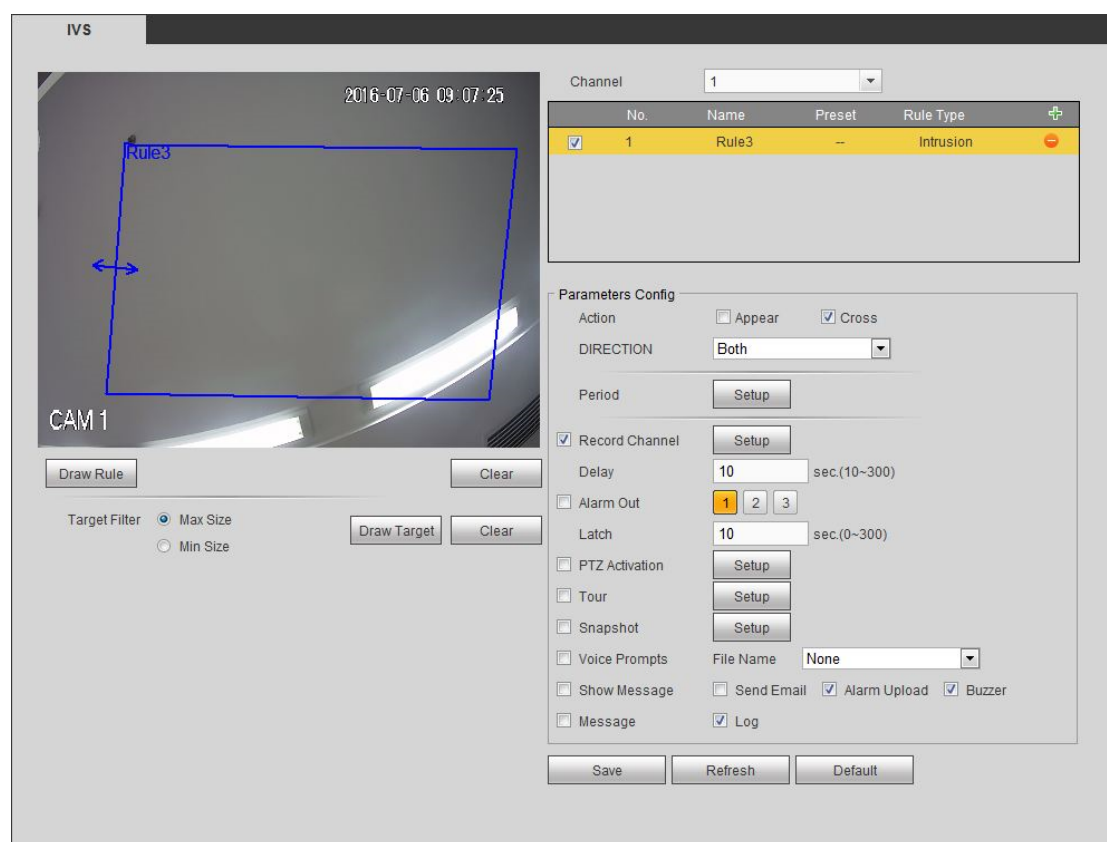

Figure 5-75

For detailed setups, please refer to chapter 5.5.3.1.1 motion detect for detailed information.

5.5.3.3.3 Abandoned Object Detect

It is to detect there is any abandoned object. Please use according to your actual situation.

Note:

- The abandoned object detection function is valid once your network camera or your

DVR supports this function.

- If you want to use the IVS function of the network camera, please make sure your connected network camera supports this function.

From main menu->Setup->Event->IVS->Object, the interface is shown as below. See Figure 5-76.

Click  to add the rule and select the rule type as Abandoned object detection, check the Abandoned object detection box to enable abandoned object detection function.

Tips

Double click to change the rule name.

Period: It refers to the time that object is staying in the zone time.

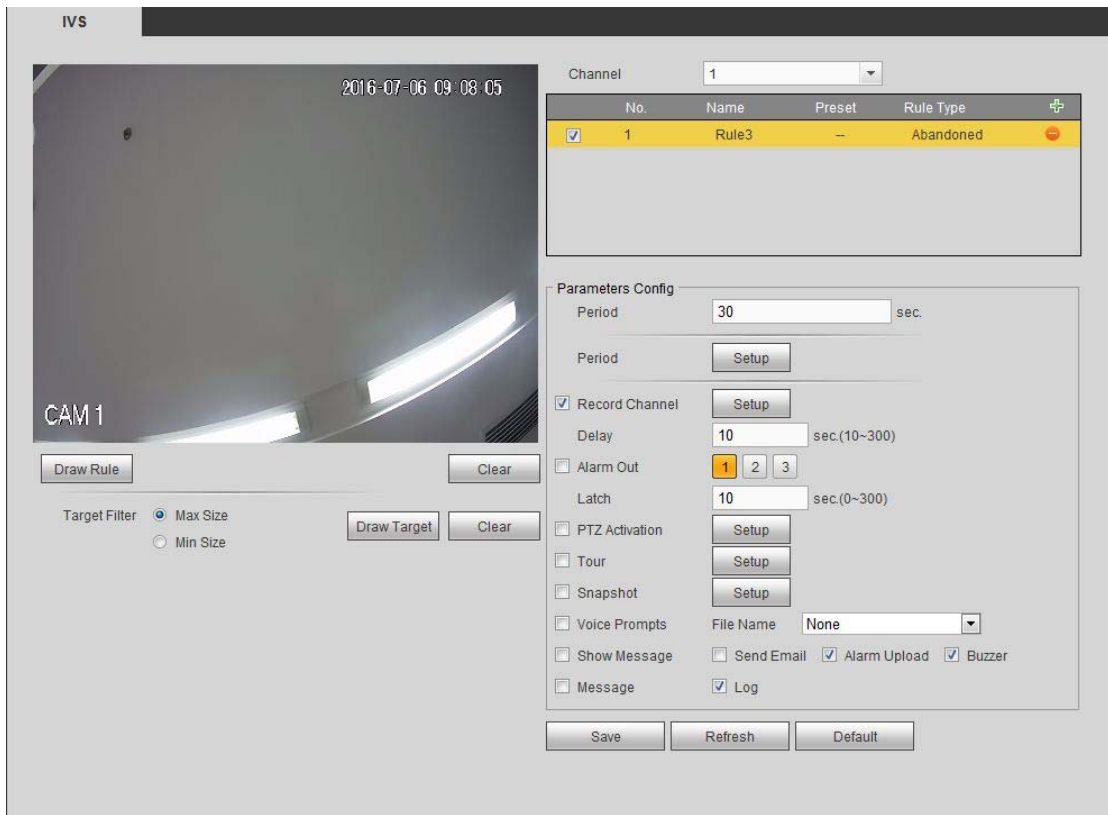
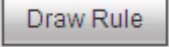

Figure 5-76

Click  to draw the rule. See Figure 5-77. Left click mouse to draw a line, until you draw a rectangle, you can right click mouse.

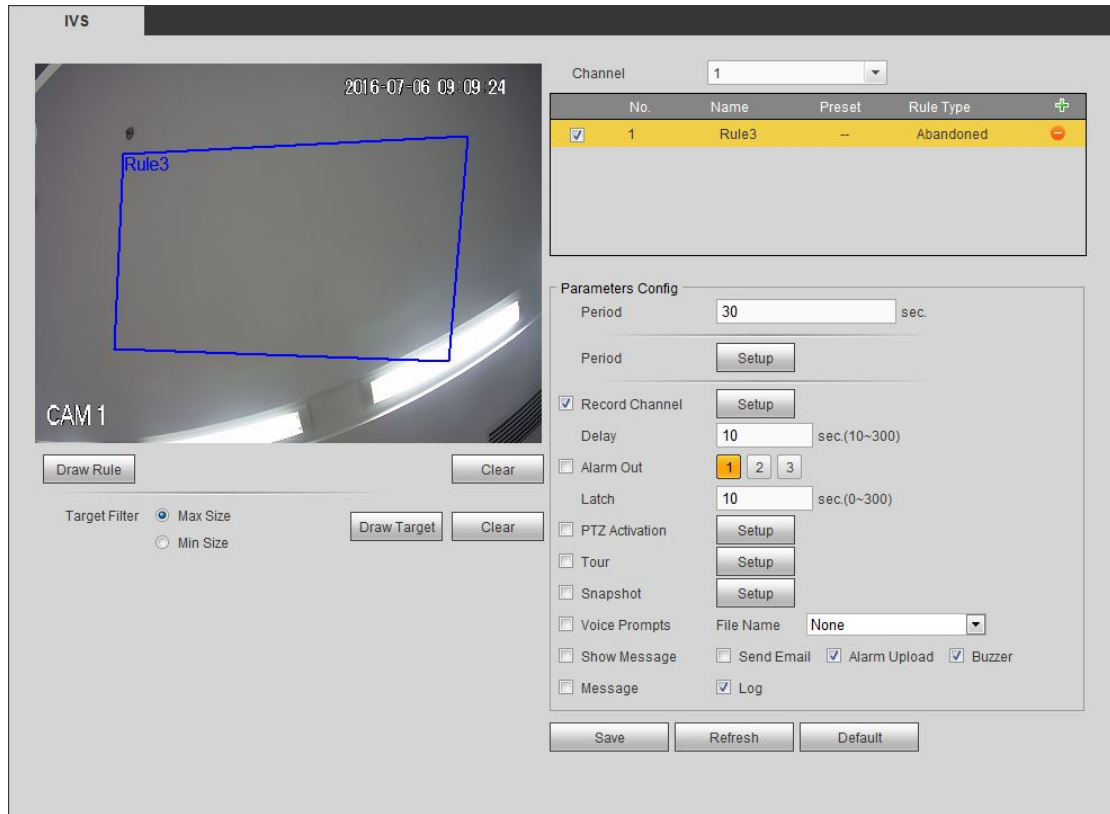

Figure 5-77

Click **Draw Target** to draw filter object. Select the blue line and then use mouse to adjust zone size.

Note

- Each rule can set two sizes (min size/max size). Once the object is smaller than the min size or larger than the max size, there is no alarm. Please make sure the max size is larger than the min size.
- The default max size is the full screen, you can select the blue line and then use mouse to adjust.
- Click Clear to clear the zone you are drawing.

Click Ok to complete the rule setup.

For detailed setups, please refer to chapter 5.5.3.1.1 motion detect for detailed information.

5.5.3.3.4 Missing Object Detect

Note:

- System supports customized area shape and amount.
- Support period setup.
- Support objects filter function.

From main menu->Setup->Event->IVS, click , and then select rule type as missing

object detection, you can see the following interface. See Figure 5-78.

Tips

Double click to change the rule name.

- Lasting period: It is the min time from the object left the zone to the alarm generation time.

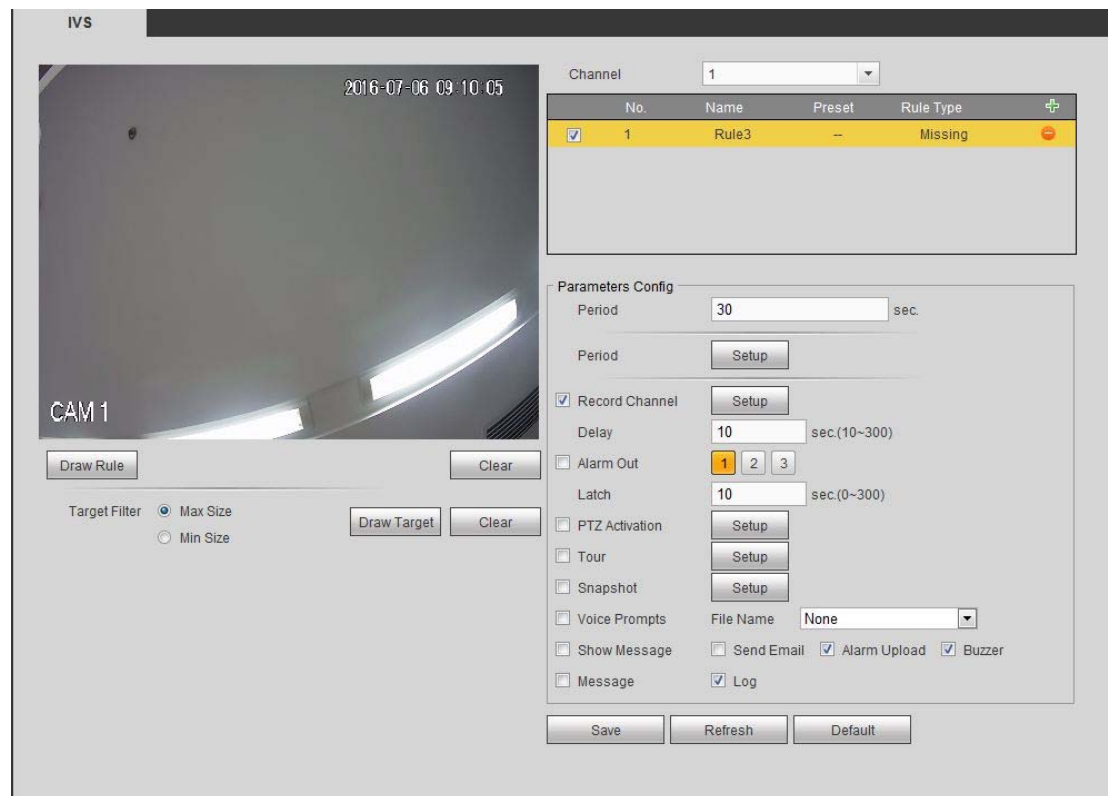
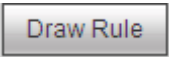

Figure 5-78

Click  to draw the rule. See Figure 5-79.

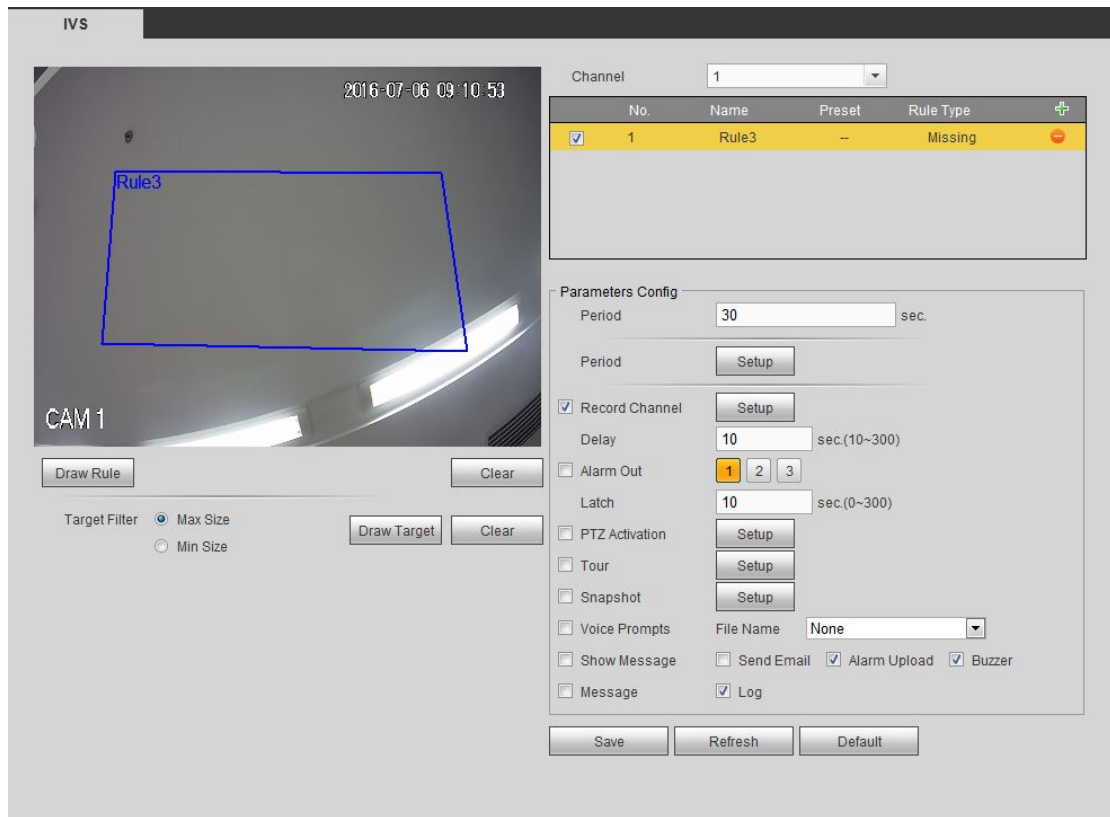
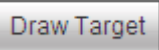

Figure 5-79

Click  to draw filter object. Select the blue line and then use mouse to adjust zone size.

Note

- Each rule can set two sizes (min size/max size). Once the object is smaller than the min size or larger than the max size, there is no alarm. Please make sure the max size is larger than the min size.
- The default max size is the full screen, you can select the blue line and then use mouse to adjust.
- Click Clear to clear the zone you are drawing.

Click Ok to complete the rule setup.

For detailed setups, please refer to chapter 5.5.3.1.1 motion detect for detailed information.

5.5.3.4 Face Detect (Optional)

When camera detects human face, system can draw a rectangle around the human face to highlight it.

From main menu->Setup->Event->Face detect, the interface is shown as in Figure 5-80.

- Enable face ROI: Check the box here, system can enhance the human face display pane. Please make sure you connected camera supports this function. Otherwise the checkbox is grey.
- Sensitivity: System supports 6 levels. The sixth level has the highest sensitivity.

Click  to draw filter object. Select the blue line and then use mouse to adjust

zone size.

Note

- Each rule can set two sizes (min size/max size). Once the object is smaller than the min size or larger than the max size, there is no alarm. Please make sure the max size is larger than the min size.
- The default max size is the full screen, you can select the blue line and then use mouse to adjust.
- Click Clear to clear the zone you are drawing.

For detailed setups, please refer to chapter 5.5.3.1.1.

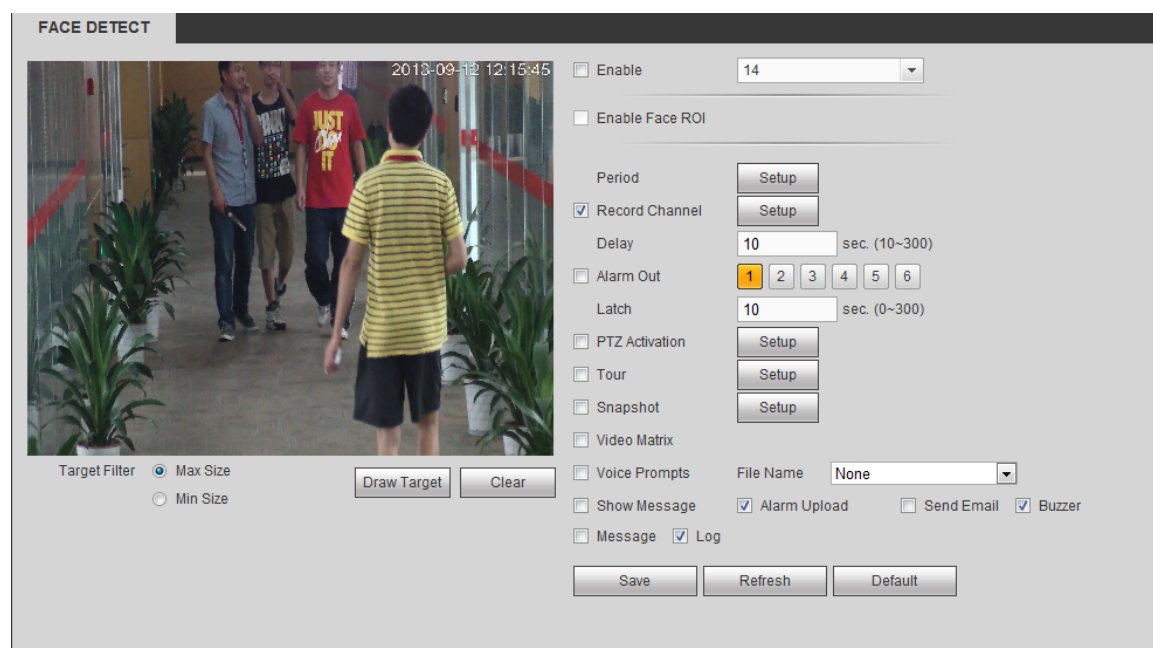

Figure 5-80

5.5.3.5 People Counting (Optional)

System can calculate the entry/exit people amount in the specified zone. It can generate an alarm when the amount has exceeded the threshold.

5.5.3.5.1 People Counting

It is to set flow statistic mode and alarm activation items.

From main menu->Setup->Event->People counting>People counting, you can see an interface shown as in Figure 5-81.

- Channel: Please select a channel from the dropdown list. Check the box to enable people counting function.
- OSD overlay: Check the box here; you can view the people amount on the surveillance video.
- Direction: It is to set people flow direction. It includes entry/exit.
- Entry No.: It is to set people entry amount. System can generate an alarm once the amount has exceeded the threshold.
- Exit No.: It is to set people entry amount. System can generate an alarm once the amount has exceeded the threshold.
- Stranded No.: It is to set people staying amount in the zone. System can generate an

alarm once the amount has exceeded the threshold.

- Video matrix: Check the box here to enable this function. Right now system supports 1-window tour function and it follows “first come, first server” rule. DVR processes the new triggered tour when the previous alarm ended. Otherwise it resumes the previous tour status before the people counting.

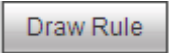
Click  to draw the rule. Left click mouse to draw a line, until you draw a rectangle, you can right click mouse.

For detailed setups, please refer to chapter 5.5.3.1.1 motion detect for detailed information.

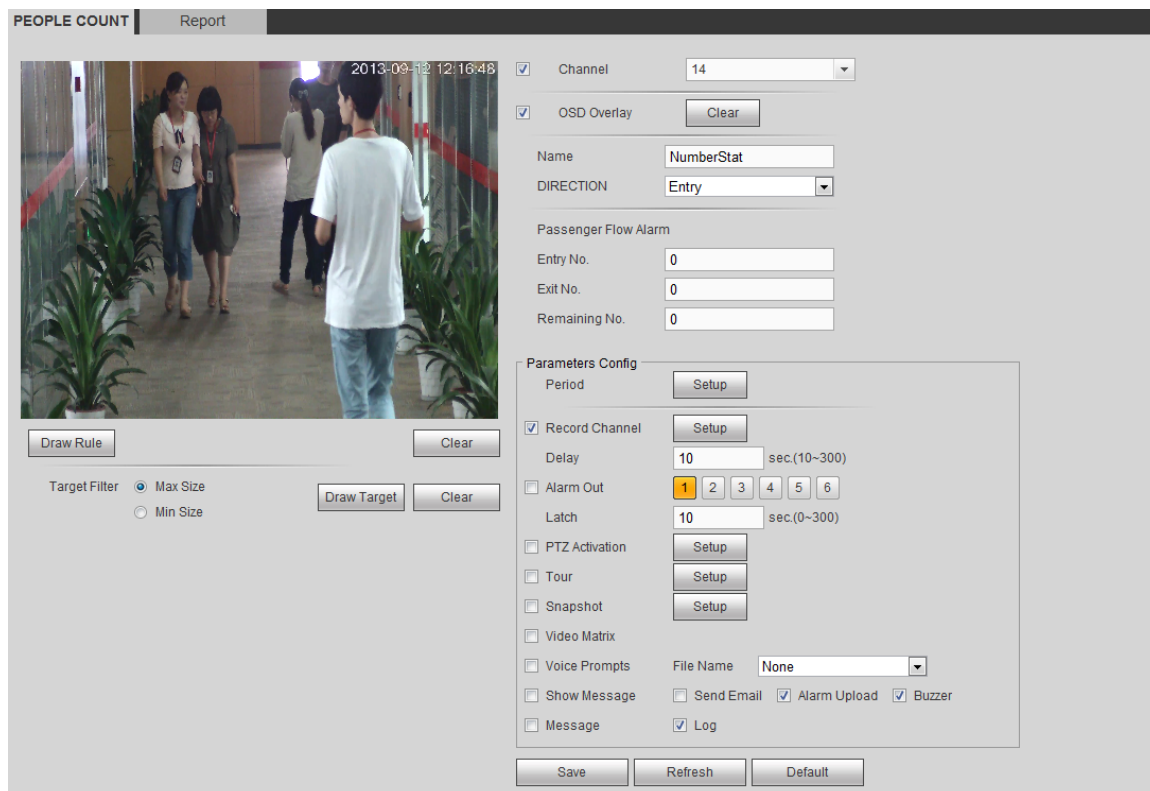

Figure 5-81

5.5.3.5.2 Report

Here you can search and view people counting result of each channel and export people counting statistics report. The export file format is *.BMP.

From main menu->Setup->Event->People counting->Report, you can see an interface shown as in Figure 5-82.

- Channel: Please select a channel from the dropdown list to search people counting result.
- Report type: Please select report type from the dropdown list. It includes daily report, monthly report, and annual report. And then select histogram graph and polygon graph. Please note the daily report max supports 24 hours.
- Start time/end time: Input the people counting start time and end time.
- Flow direction: Check the box to set flow direction such as enter/exit.
- Display number: Check the box, the DVR can display the entry and exit people

amount in the report.

- Search: Click Search button, you can view the people counting report at the bottom of the interface.
- Export: Click it and then select path, click Save button to save people counting report to your local PC.

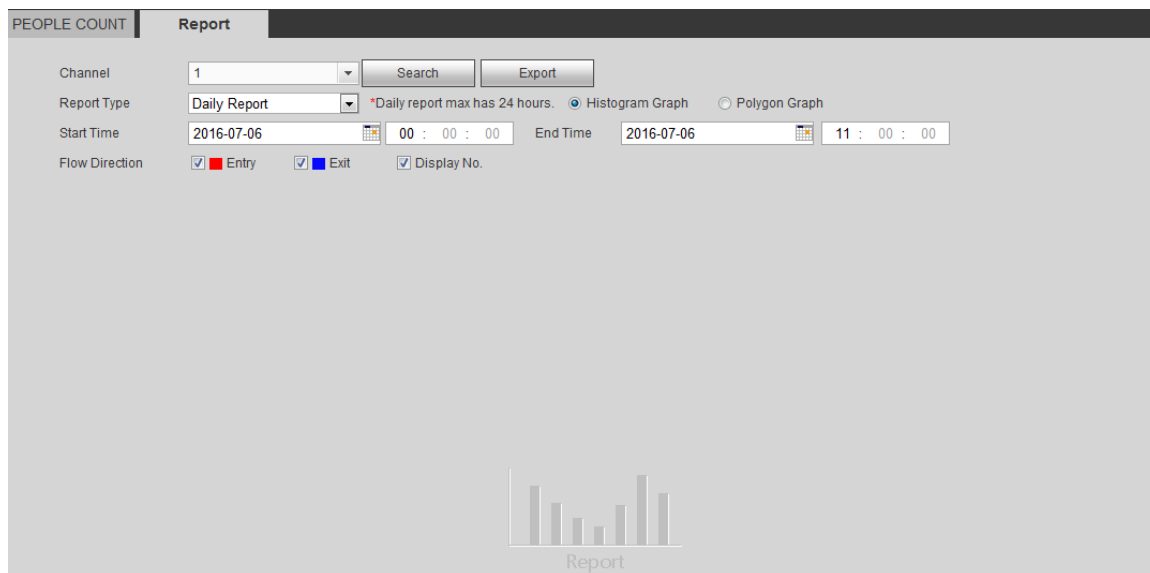

Figure 5-82

5.5.3.6 Audio Detect

Important

- Please connect to a smart network camera if you want to use audio detection function.
- Please make sure the connected smart network camera supports audio detection function.

System can generate an alarm once it detect the audio input is abnormal or audio volume changes.

From main menu->Setup->Event->Audio detect, you can see an interface shown as in Figure 5-83.

- Input abnormal: Check the box here, system can generate an alarm once the audio input is abnormal.
- Intensity change: Check the box here, system can generate an alarm once the audio volume becomes strong.
- Sensitivity: It refers to the audio recognition sensitivity. The higher the value is, the higher the sensitivity is.
- Threshold: It is to set intensity change threshold. The smaller the value is, the higher the sensitivity is.

For detailed setups, please refer to chapter 5.5.3.1.1 motion detect for detailed information.

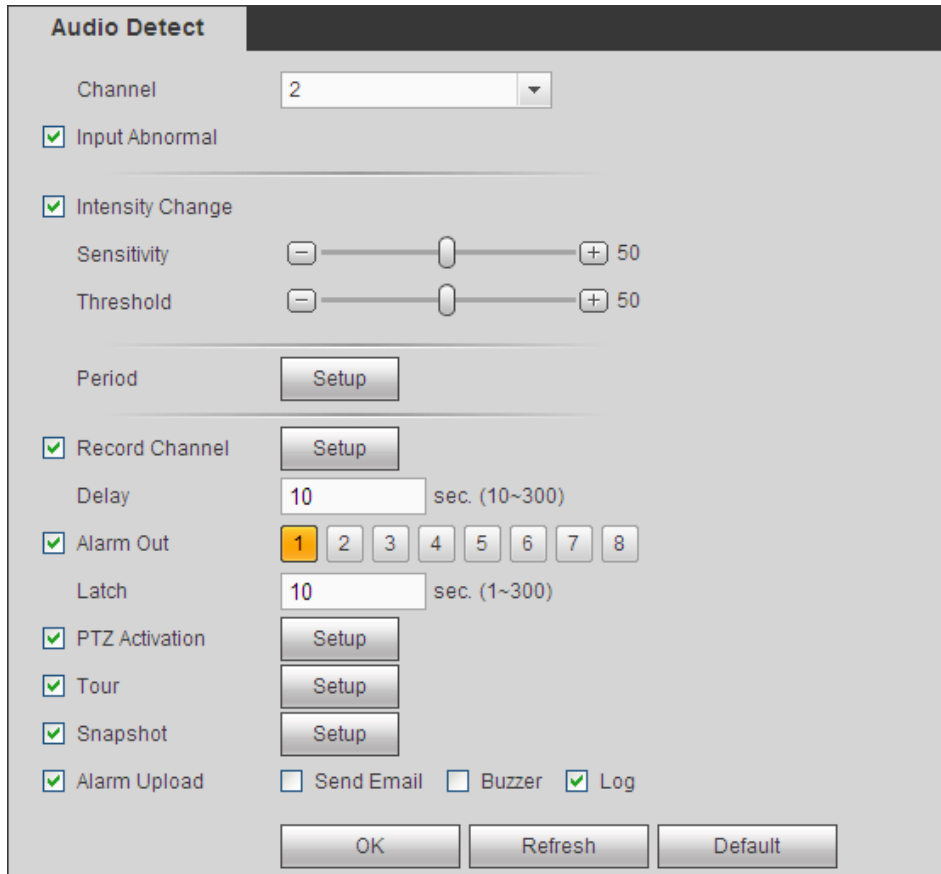

Figure 5-83

5.5.3.7 Smart Track

Important

- The fisheye and the PTZ camera shall surveillance proper zone.
- The fisheye and the PTZ camera shall use the private protocol to add.

The smart track function refers to a system consisting of the fisheye and the PTZ camera. The fisheye is the master camera to view the whole surveillance situation, and the PTZ camera is the slave camera to view the details.

From main menu->Setup->Event->Smart Track, the interface is shown as in Figure 5-84.

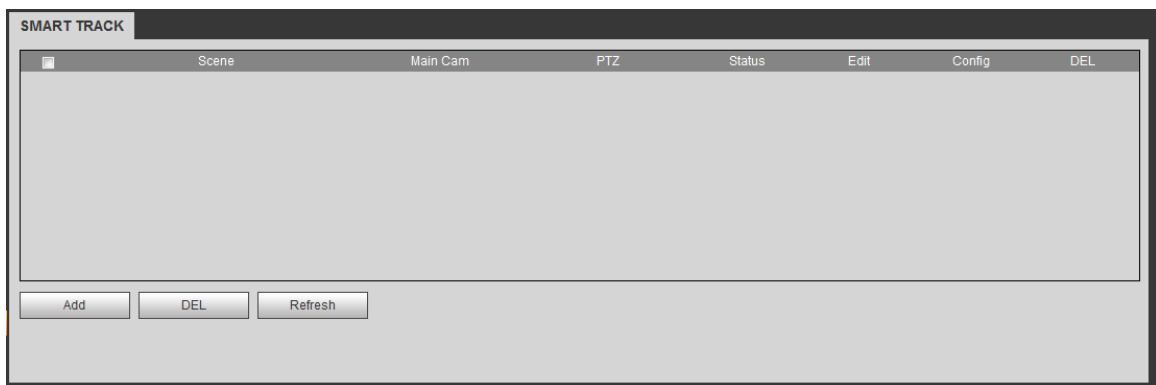

Figure 5-84

Click Add button, the interface is shown as below. See Figure 5-85.

- Type: Here you can select smart track mode. It includes: 1 fisheye+1 PTZ camera/1 fisheye+2 PTZ cameras/1 fisheye+3 PTZ cameras.
- Scene: It is the monitor position. Input customized monitor position name.
- Main channel: Click Select button and then select fisheye from the dialogue box. Now you can view channel number and channel name.
- PTZ camera: Click Select button and then select corresponding PTZ camera amount from the dialogue box. Now you can view PTZ camera channel number, channel name and IP address.

Click OK to complete the setup.

The 'Add' dialog box contains the following elements:

- Type:** Two dropdown menus. The first is set to 'Fisheye+PTZ' and the second to '1 Fisheye+1'.
- Scene:** An empty text input field.
- Main Cam:** A text input field followed by a 'Select' button.
- PTZ:** A 'Select' button.
- Table:** A table with three columns: 'Channel', 'CAM NAME', and 'IP Address'. The table is currently empty.
- Buttons:** 'OK' and 'Cancel' buttons at the bottom.

Figure 5-85

After you go back to the smart track interface, it is shown as in Figure 5-86.

The 'SMART TRACK' interface displays the following table:

Scene	Main Cam	PTZ	Status	Edit	Config	DEL
Door	9	8				

Below the table are three buttons: 'Add', 'DEL', and 'Refresh'.

Figure 5-86





In Figure 5-86, click  or double click the line, you can go to the following interface. See Figure 5-87. Here you can set the fisheye and PTZ camera bonding relationship.









Figure 5-87

On the fisheye displayed zone, left click mouse or move  to confirm the position. On the PTZ camera displayed zone, use the following buttons to adjust the PTZ camera position. It is to move the center position of the PTZ camera is the same as the  position of the fisheye.

Note

The  of the PTZ camera is the center position of the video.

Button	Function
	Zoom
	Focus
	Iris
	Electronic mouse, move it on the interface to control the PTZ direction.

Button	Function
	Fast positioning button. Click it first and then click any position in the video. Left click mouse, you can view the video from the specified position.
	It is to control PTZ movement speed. The higher the value is, the faster the speed is. For example, the step 8 speed is faster than step 1.

Click add button and then click  to save.

Now you complete one group position, you can view at the list. See Figure 5-88.



Main Cam	PTZ	Zoom	OPERATION	DEL
3942,816	1077,-20	128		

Figure 5-88

Repeat the above steps to set at least three group positions.

Note

- For one PTZ camera, there must be three calibration groups. System max supports 8 group positions. Please make sure the calibration position is accurate.
- For the first calibration group position, please select the reference objects at the far distance to enhance the trigger accuracy.

Click OK button to complete the calibration setup, you can go back to the smart track

interface, the status is shown as .

5.5.3.8 Alarm

Before operation, please make sure you have properly connected alarm devices such as buzzer. The input mode includes local alarm/network alarm/IPC external alarm/IPC offline alarm.

5.5.3.8.1 Local Alarm

From main menu->Setup->Event->Alarm, the local alarm interface is shown as in Figure 5-89. It refers to alarm from the local device.

Local Alarm | Net Alarm | IPC External Alarm | IPC Offline Alarm

Enable 1 Alarm Name: Alarm In1

Period Setup

Anti-dither 5 sec.(0-600) Type: NO

Record Channel Setup

Delay 10 sec.(10~300)

Alarm Out 1 2 3 4 5 6

Latch 10 sec.(0~300)

PTZ Activation Setup

Tour Setup

Snapshot Setup

Video Matrix

Voice Prompts File Name: None

Show Message Send Email Alarm Upload Buzzer

Message Log

Copy Save Refresh Default

Figure 5-89

Setup [X]

Thursday [v] Copy

<input checked="" type="checkbox"/>	00 : 00	-	24 : 00
<input type="checkbox"/>	00 : 00	-	24 : 00
<input type="checkbox"/>	00 : 00	-	24 : 00
<input type="checkbox"/>	00 : 00	-	24 : 00
<input type="checkbox"/>	00 : 00	-	24 : 00
<input type="checkbox"/>	00 : 00	-	24 : 00

Save Cancel

Figure 5-90

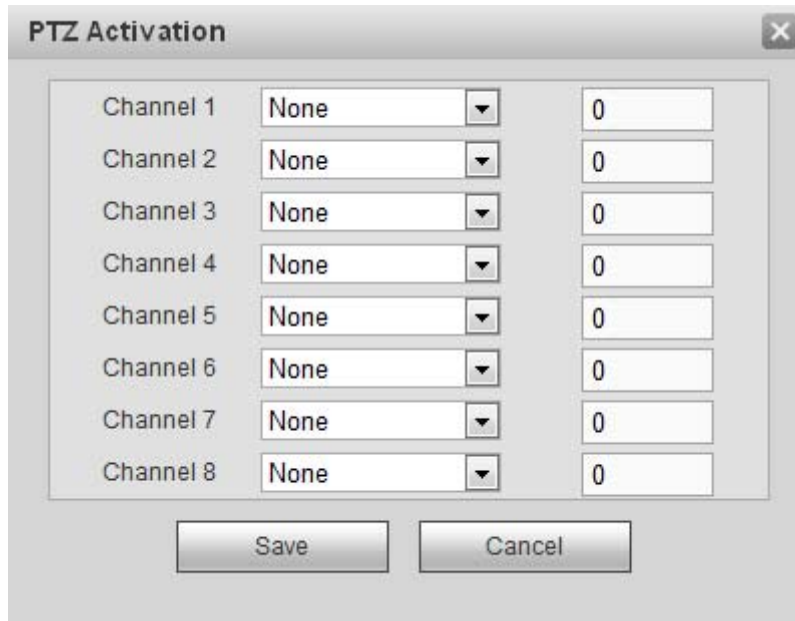

Figure 5-91

Please refer to the following sheet for detailed information.

Parameter	Function
Enable	You need to check the box to enable this function. Please select a channel from the dropdown list.
Period	This function becomes activated in the specified periods. There are six periods in one day. Please draw a circle to enable corresponding period. Select date. If you do not select, current setup applies to today only. You can select all week column to apply to the whole week. Click OK button, system goes back to local alarm interface, please click save button to exit.
Anti-dither	System only memorizes one event during the anti-dither period. The value ranges from 5s to 600s.
Sensor type	There are two options: NO/NC.
Record channel	System auto activates motion detection channel(s) to record once an alarm occurs. Please note you need to set alarm record period and go to Storage-> Schedule to set current channel as schedule record.
Record Delay	System can delay the record for specified time after alarm ended. The value ranges from 10s to 300s.
Alarm out	Enable alarm activation function. You need to select alarm output port so that system can activate corresponding alarm device when an alarm occurs.
Latch	System can delay the alarm output for specified time after an alarm ended. The value ranges from 1s to 300s.
Show message	System can pop up a message to alarm you in the local host screen if you enabled this function.

Parameter	Function
Buzzer	Check the box here to enable this function. The buzzer beeps when an alarm occurs.
Alarm upload	System can upload the alarm signal to the centre (Including alarm centre).
Send Email	If you enabled this function, System can send out an email to alert you when an alarm occurs.
Tour	You need to check the box here to enable this function. System begins 1-window or multiple-window tour display among the channel(s) you set to record when an alarm occurs.
PTZ Activation	Here you can set PTZ movement when alarm occurs. Such as go to preset X.
Log	Check the box here, system can record local alarm event log.

5.5.3.8.2 Net Alarm

From main menu->Setup->Event->Alarm, the network alarm interface is shown as in Figure 5-92.

Network alarm refers to the alarm signal from the network. System does not anti-dither and sensor type setup. For setup information, please refer to chapter 5.5.3.8.1.

The screenshot shows the 'Net Alarm' configuration page. At the top, there are four tabs: 'Local Alarm', 'Net Alarm' (which is active), 'IPC External Alarm', and 'IPC Offline Alarm'. Below the tabs, the configuration is organized into several sections:

- Enable:** A checked checkbox, a dropdown menu set to '1', and an 'Alarm Name' field containing 'Alarm In1'.
- Period:** A 'Setup' button.
- Record Channel:** A checked checkbox and a 'Setup' button.
- Delay:** A text input field with '10' and a unit label 'sec.(10~300)'.
- Alarm Out:** A checked checkbox and a row of six buttons labeled '1' through '6'. Button '1' is highlighted in yellow.
- Latch:** A text input field with '10' and a unit label 'sec.(0~300)'.
- PTZ Activation:** An unchecked checkbox and a 'Setup' button.
- Tour:** An unchecked checkbox and a 'Setup' button.
- Snapshot:** An unchecked checkbox and a 'Setup' button.
- Video Matrix:** An unchecked checkbox.
- Voice Prompts:** An unchecked checkbox and a 'File Name' dropdown menu set to 'None'.
- Show Message:** An unchecked checkbox, with sub-options for 'Send Email' (unchecked) and 'Buzzer' (unchecked).
- Message:** An unchecked checkbox, with a sub-option for 'Log' (checked).

At the bottom of the interface, there are four buttons: 'Copy', 'Save', 'Refresh', and 'Default'.

Figure 5-92

5.5.3.8.3 IPC External Alarm

From main menu->Setup->Event->Alarm, IPC external alarm interface is shown as below. See Figure 5-93. For setup information, please refer to chapter 5.5.3.8.1.

The screenshot shows the 'IPC External Alarm' configuration page. At the top, there are four tabs: 'Local Alarm', 'Net Alarm', 'IPC External Alarm' (which is active), and 'IPC Offline Alarm'. Below the tabs, the configuration is organized into several sections:

- Channel:** A checked checkbox, a dropdown menu showing '16', and an 'Alarm Name' field containing 'Alarm In16'.
- Period:** A 'Setup' button.
- Anti-dither:** A text input field with '5' and 'sec.(0-600)'.
- Type:** A dropdown menu showing 'NC'.
- Record Channel:** A checked checkbox and a 'Setup' button.
- Delay:** A text input field with '10' and 'sec.(10-300)'.
- Alarm Out:** A checked checkbox and a row of six buttons labeled '1' through '6', with '1' highlighted in yellow.
- Latch:** A text input field with '10' and 'sec.(0-300)'.
- PTZ Activation:** An unchecked checkbox and a 'Setup' button.
- Tour:** An unchecked checkbox and a 'Setup' button.
- Snapshot:** An unchecked checkbox and a 'Setup' button.
- Video Matrix:** An unchecked checkbox.
- Voice Prompts:** An unchecked checkbox and a 'File Name' dropdown menu showing 'None'.
- Show Message:** An unchecked checkbox and three sub-options: 'Send Email' (unchecked), 'Alarm Upload' (checked), and 'Buzzer' (unchecked).
- Message:** An unchecked checkbox and a 'Log' checkbox (checked).

At the bottom of the page, there are four buttons: 'Copy', 'Save', 'Refresh', and 'Default'.

Figure 5-93

5.5.3.8.4 IPC Offline Alarm

From main menu->Setup->Event->Alarm, IPC offline alarm is shown as in Figure 5-94. For setup information, please refer to chapter 5.5.3.8.1.

The screenshot shows the 'IPC Offline Alarm' configuration page. At the top, there are four tabs: 'Local Alarm', 'Net Alarm', 'IPC External Alarm', and 'IPC Offline Alarm' (which is active). Below the tabs, the configuration is organized into several sections:

- Channel:** A checked checkbox, a dropdown menu showing '16', and an 'Alarm Name' field (partially visible).
- Record Channel:** An unchecked checkbox and a 'Setup' button.
- Delay:** A text input field with '10' and 'sec.(10-300)'.
- Alarm Out:** A checked checkbox and a row of six buttons labeled '1' through '6', with '1' highlighted in yellow.
- Latch:** A text input field with '10' and 'sec.(0-300)'.
- PTZ Activation:** A checked checkbox and a 'Setup' button.
- Tour:** An unchecked checkbox and a 'Setup' button.
- Snapshot:** An unchecked checkbox and a 'Setup' button.
- Video Matrix:** An unchecked checkbox.
- Voice Prompts:** An unchecked checkbox and a 'File Name' dropdown menu showing 'None'.
- Show Message:** An unchecked checkbox and three sub-options: 'Send Email' (unchecked), 'Alarm Upload' (checked), and 'Buzzer' (unchecked).
- Message:** An unchecked checkbox and a 'Log' checkbox (checked).

At the bottom of the page, there are four buttons: 'Copy', 'Save', 'Refresh', and 'Default'.

Figure 5-94

5.5.3.9 Abnormality

From main menu->Setup->Event->Abnormality, it includes four types: HDD/Network/User/Device. See Figure 5-95 through Figure 5-98.

The screenshot shows the 'HDD' tab selected in the top navigation bar. The 'Event Type' dropdown is set to 'No HDD'. The configuration options include:

- Enable
- Alarm Out: 1 2 3 4 5 6 (button 1 is highlighted)
- Latch: 10 sec.(0~300)
- Voice Prompts: File Name: None
- Show Message: Send Email Alarm Upload Buzzer
- Message: Log

Buttons for 'Save' and 'Refresh' are at the bottom.

Figure 5-95

The screenshot shows the 'Network' tab selected in the top navigation bar. The 'Event Type' dropdown is set to 'Disconnect'. The configuration options include:

- Enable
- Record Channel: 1 2 3 4 5 6 7 8 9 10 11 12 13 14 15 16 (button 1 is highlighted)
- Delay: 10 sec.(10~300)
- Alarm Out: 1 2 3 4 5 6 (button 1 is highlighted)
- Latch: 10 sec.(0~300)
- Voice Prompts: File Name: None
- Show Message: Send Email Buzzer
- Message: Log

Buttons for 'Save' and 'Refresh' are at the bottom.

Figure 5-96

HDD | Network | **User** | Device

Event Type:

Enable

Attempt(s):

Lock Time: Min.

Alarm Out:

Latch: sec.(0~300)

Voice Prompts: File Name:

Send Email Buzzer

Message Log

Figure 5-97

HDD | Network | User | **Device**

Event Type:

Alarm Name:

Max Temperature: °C

Enable

Alarm Out:

Latch: sec.(0~300)

Voice Prompts: File Name:

Show Message Send Email Buzzer

Message Log

Figure 5-98

Please refer to the following sheet for detailed information.

Parameter	Function
Event Type	<p>The abnormal events include:</p> <ul style="list-style-type: none"> ● HDD: No disk, disk error, disk no space; ● Network: Net disconnection, IP conflict, MAC conflict. ● User: Illegal login. ● Device: Temperature is too high, fan speed is abnormal. Please note this function is for some series product only. <p>You can set one or more items here.</p> <ul style="list-style-type: none"> ● Less than: You can set the minimum percentage value here. The device can generate an alarm when capacity is not sufficient. This

Parameter	Function
	<p>item is for disk no space type only.</p> <ul style="list-style-type: none"> ● Max temperature: You can set max temperature value here. The device can generate an alarm once the device temperature is higher than the threshold you set. This item is for high temperature type only.
Enable	Check the box here to enable selected function.
Alarm Out	Please select corresponding alarm output channel when an alarm occurs. You need to check the box to enable this function.
Latch	The alarm output can delay for the specified time after an alarm stops. The value ranges from 0s to 300s. The default setup is 10 seconds. The 0 second means there is no delaying time.
Attempt(s)	It is to set login attempt times. Once the login attempt exceeds the threshold you set here, current account will be locked. This function is illegal login only.
Lock time	It is to set account lock time once its login attempt has exceeded the threshold you set. This function is for illegal login only.
Show message	System can pop up a message to alarm you in the local host screen if you enabled this function.
Alarm upload	System can upload the alarm signal to the centre (Including alarm centre).
Send Email	If you enabled this function, System can send out an email to alert you when an alarm occurs.
Buzzer	Check the box here to enable this function. The buzzer beeps when an alarm occurs.
Log	Check the box here, system can record the network event alarm log.

5.5.3.10 Alarm Output

From main menu->Setup->Event->Alarm output, it is to set alarm output mode. See Figure 5-99.

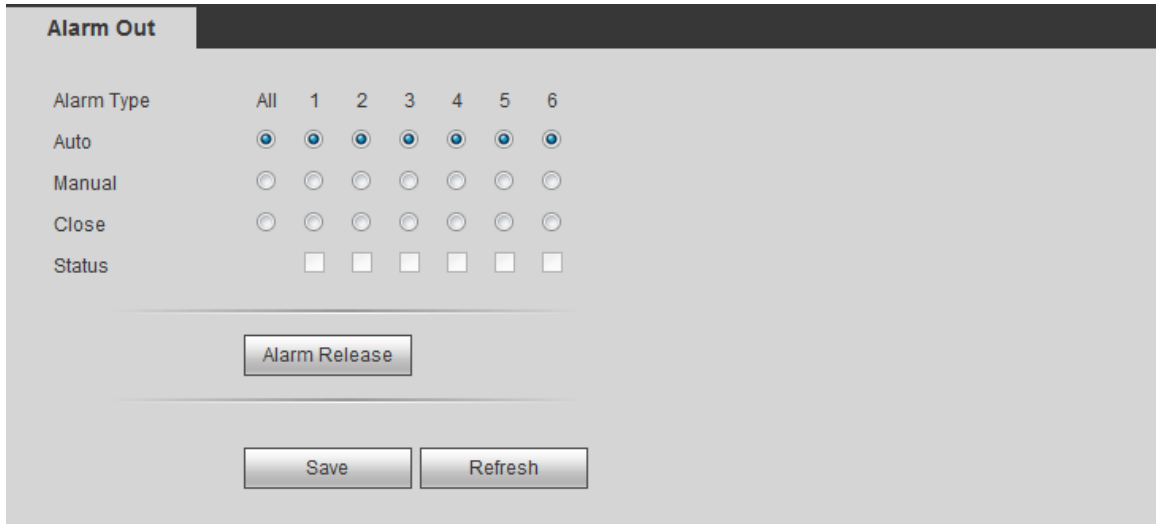

Figure 5-99

Please refer to the following sheet for detailed information.

Parameter	Function
Auto	The corresponding event triggers the alarm output or cancels alarm.
Manual	Forcedly trigger alarm output.
Close	Forcedly cancel or close alarm output.
Status	Here you can view alarm output port status. The alarm is enabled if the icon is highlighted.
Alarm release	Click the button, you can clear all alarm output status.

5.5.4 Storage

5.5.4.1 Schedule

5.5.4.1.1 Schedule Record

From main menu->Setup->Storage->schedule, you can add or remove the schedule record setup. See Figure 5-100.

There are five record modes: general (auto), motion detect and alarm, and intelligent. There are six periods in one day.

You can view the current time period setup from the color bar.

- Green color stands for the general record/snapshot.
- Yellow color stands for the motion detect record/snapshot..
- Red color stands for the alarm record/snapshot.
- Blue color stands for MD&alarm record/snapshot.
- Orange color stands for intelligent record.

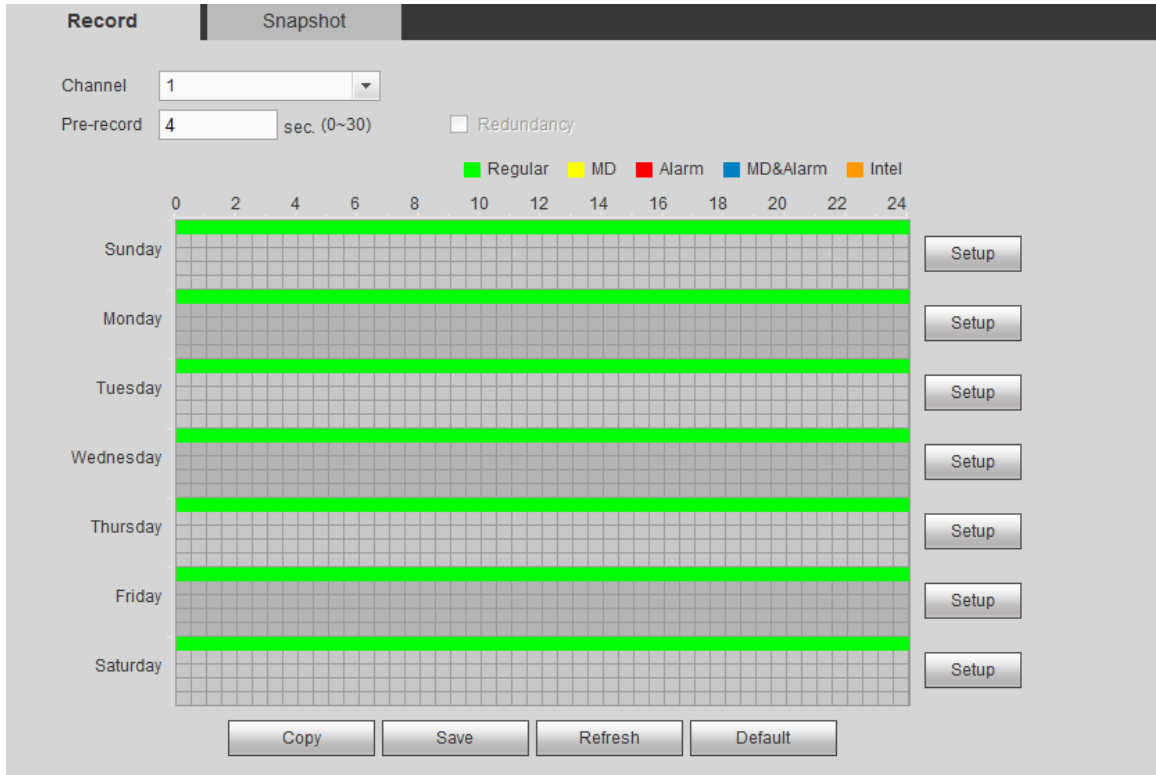

Figure 5-100

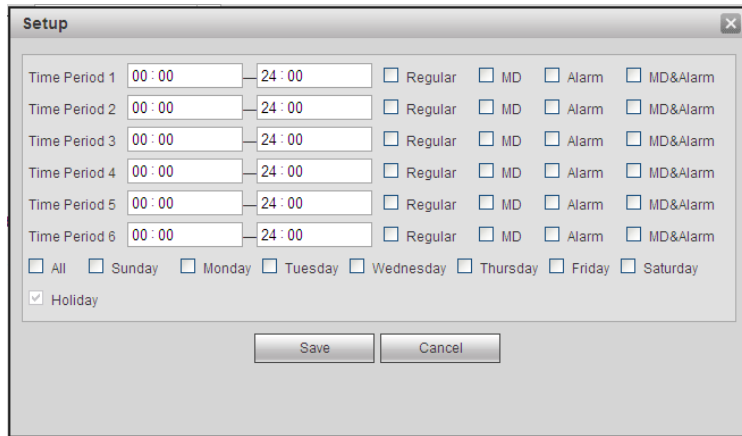

Figure 5-101

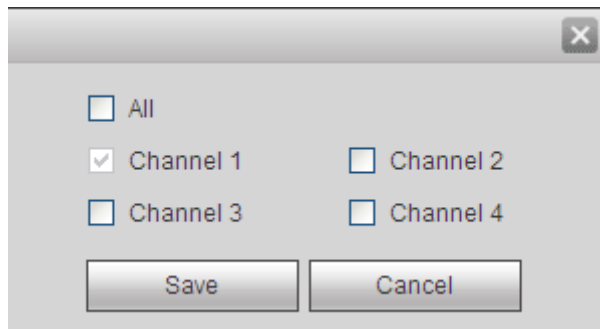

Figure 5-102

Please refer to the following sheet for detailed information.

Parameter	Function
Channel	Please select a channel from the dropdown list.
Pre-record	Please input pre-record time here. The value ranges from 0 to 30.
Redundancy	Check the box here to enable redundancy function. Please note this function is null if there is only one HDD.
Snapshot	Check the box here to enable snapshot function.
Holiday	Check the box here to enable holiday function.
Setup (Sunday to Saturday)	Click the Setup button, you can set record period. See Figure 5-101. There are six periods in one day. If you do not check the date at the bottom of the interface, current setup is for today only. Please click Save button and then exit.
Setup (Holiday)	Click the Setup button, you can set record period. See Figure 5-101. There are six periods in one day. If you check Holiday box, current channel shall record as your holiday setup here.
Copy	Copy function allows you to copy one channel setup to another. After setting in channel, click Copy button, you can go to interface Figure 5-102. You can see current channel name is grey such as channel 1. Now you can select the channel you want to paste such as channel 5/6/7. If you want to save current setup of channel 1 to all channels, you can click the first box "ALL". Click the OK button to save current copy setup. Click the OK button in the Encode interface, the copy function succeeded.

5.5.4.1.2 Schedule snapshot

The schedule snapshot interface is shown as below. See Figure 5-103.

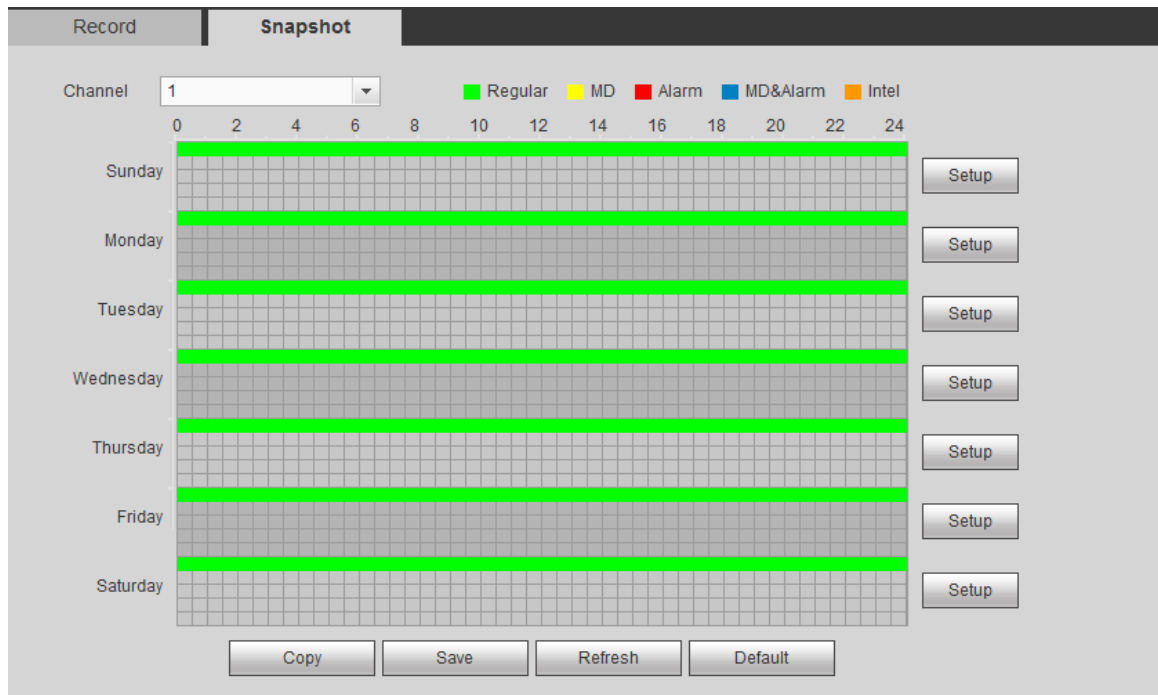

Figure 5-103

For detailed operation information, please refer to chapter 5.5.4.1.1.

5.5.4.2 HDD Manage

From main menu->Setup->Storage->HDD manager, the interface is shown as in Figure 5-104. Here you can see HDD information. You can also operate the read-only, read-write, redundancy (if there are more than on HDD) and format operation.

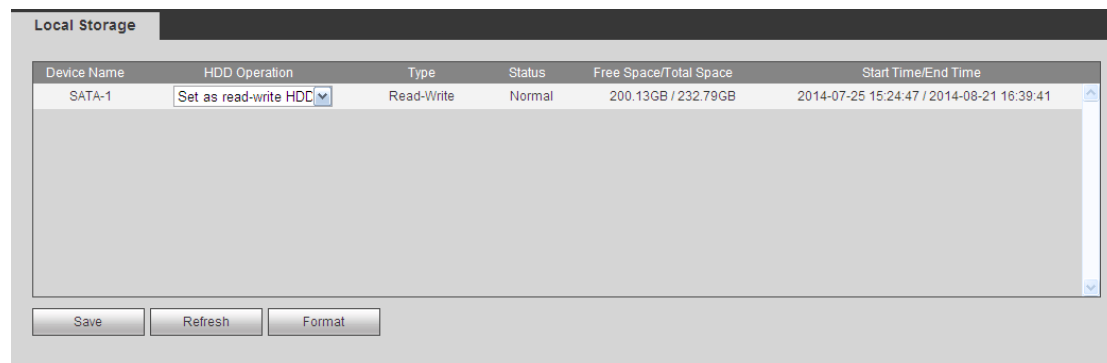

Figure 5-104

5.5.4.3 Manual Record

From main menu->Setup->Storage->Record, the interface is shown as in Figure 5-105.

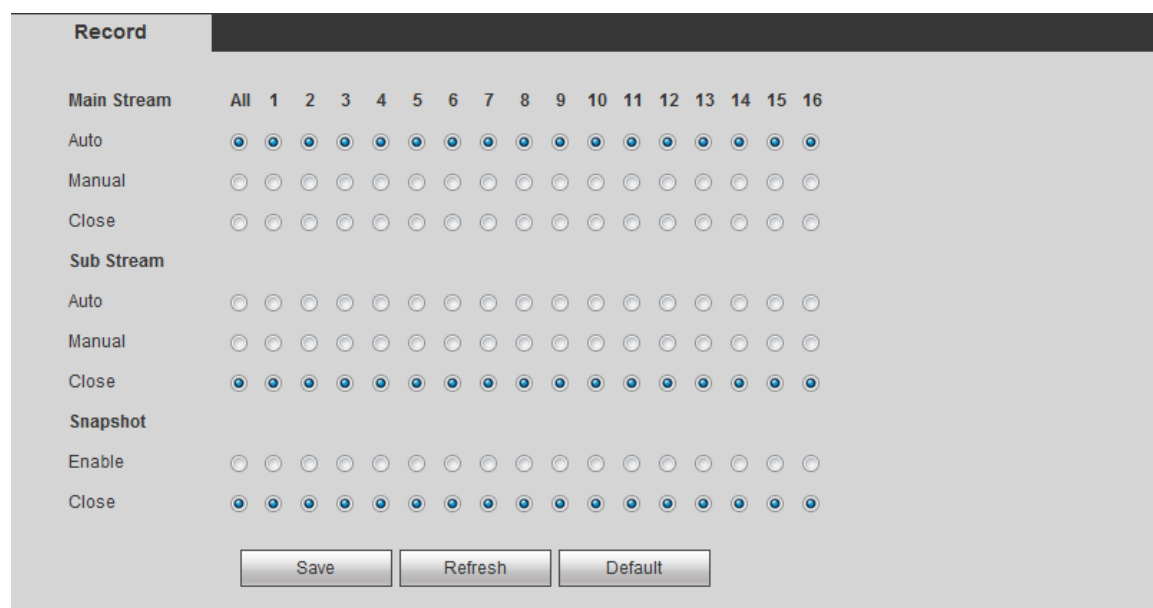

Figure 5-105

Please refer to the following sheet for detailed information.

Parameter	Function
Channel	Here you can view channel number. The number displayed here is the max channel amount of your device.
Status	There are three statuses: schedule, manual and stop.
Schedule	System enables auto record function as you set in record schedule setup (general, motion detect and alarm).

Manual	It has the highest priority. Enable corresponding channel to record no matter what period applied in the record setup.
Stop	Stop current channel record no matter what period applied in the record setup.
Start all/ stop all	Check the corresponding All button, you can enable or disable all channels record.

5.5.4.4 Advanced

5.5.4.4.1 HDD

From main menu->Setup->Storage->Advanced->HDD, the HDD interface is shown as below. See Figure 5-106. Here you can set HDD group.

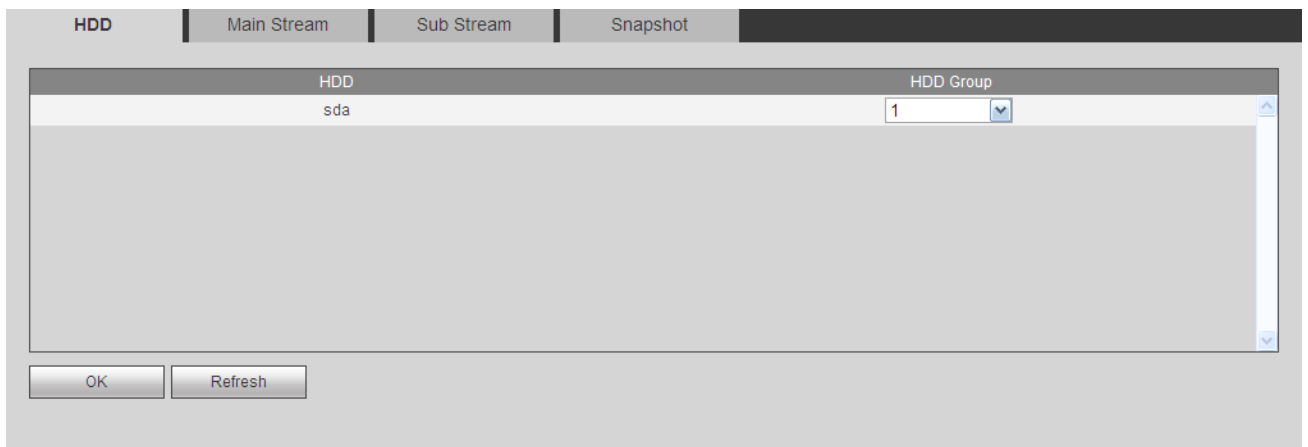

Figure 5-106

5.5.4.4.2 Main Stream

From main menu->Setup->Storage->Advanced->Main stream, the main stream interface is shown as in Figure 5-107. Here you can set corresponding HDD group to save main stream.

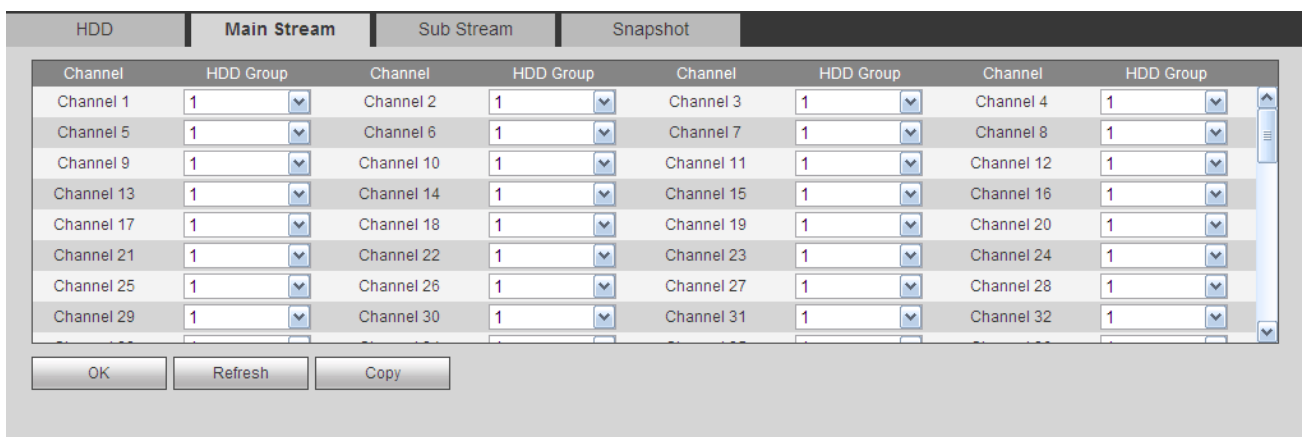

Figure 5-107

5.5.4.4.3 Sub Stream

From main menu->Setup->Storage->Advanced->Sub stream, the sub stream interface is shown as in Figure 5-108.

Here you can set corresponding HDD group to save sub stream.

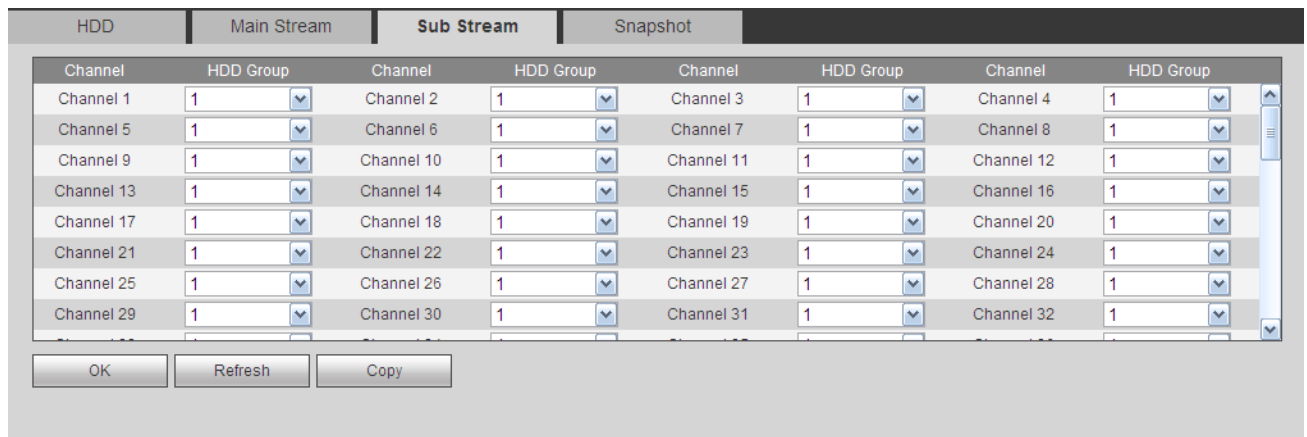

Figure 5-108

5.5.4.4 Snapshot

From main menu->Setup->Storage->Advanced->Snapshot, the snapshot interface is shown as in Figure 5-109 . Here you can set corresponding HDD group to save snapshot picture.

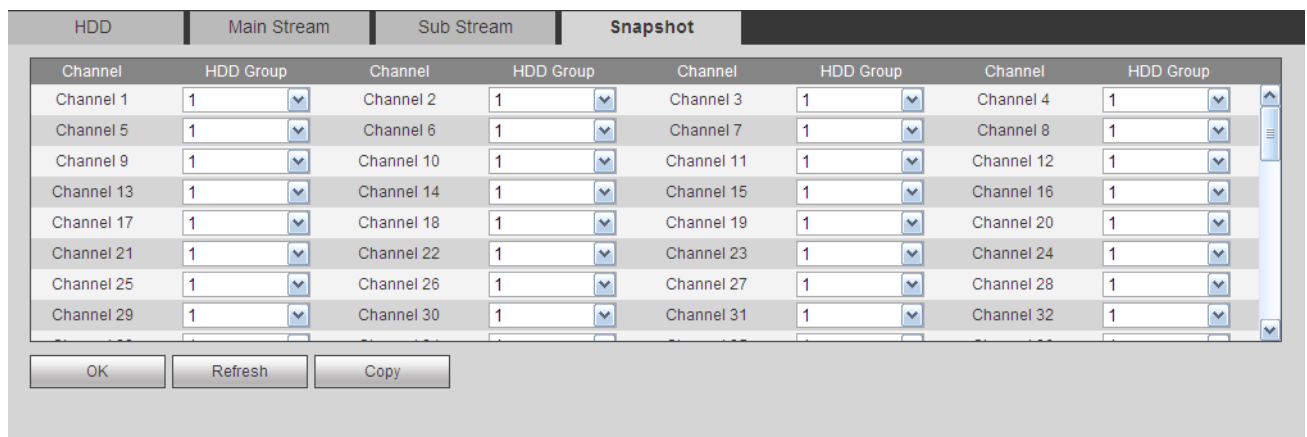

Figure 5-109

5.5.4.5 RAID Manager

Important

Please make sure your purchased product support the RAID function, otherwise you can not see the following interface.

The RAID (redundant array of independent disks) management can compost the independent HDDs together to provide larger space as the logic HDD. It can enhance system I/O performance, data usage and data security.

Right now system supports RAID0/RAID1/RAID5/RAID10.

RAID Type	HDD Amount
RAID0	At least 2 HDDs
RAID1	Only 2 HDDs

RAID Type	HDD Amount
RAID5	At least 3 HDDs. Usually we recommend 4 to 6 HDDs.
RAID10	At least 4 HDDs. The amount shall be even number.

5.5.4.5.1 RAID Config

From main menu->Setup->Storage->RAID->RAID config, you can go to the following interface. See Figure 5-110.

It is for you to manage RAID HDD. It can display RAID name, type, free space, total space, status and etc. Here you can add/delete RAID HDD.

- Create manually: It is to create RAID manually. Please select RAID type first and then follow the prompts to set HDD amount. Click Create Manually button, system pops up dialogue box to warning you it is going to clear all data. Click OK button to complete the operation.
- Create RAID: Click it to automatically create RAID.

For create RAID function, you can select the physical HDD that does not included in the RAID group or the created disk array to create a RAID5. You can refer to the following situations:

- There is no RAID, no hotspare disk: System directly creates the RAID5 and creates one hotspare disk at the same time.
- There is no RAID, but there is a hotspare disk: System creates the RAID5 only. It uses previous hotspare disk.
- There is RAID: System cancel the previous RAID setup and then create the new RAID5. System creates the hotspare disk if there is no one. System uses previous hotspare disk if there is hotspare disk available.

Click Add button to select RAID type and then select HDDs, click OK button to add. See Figure 5-110.

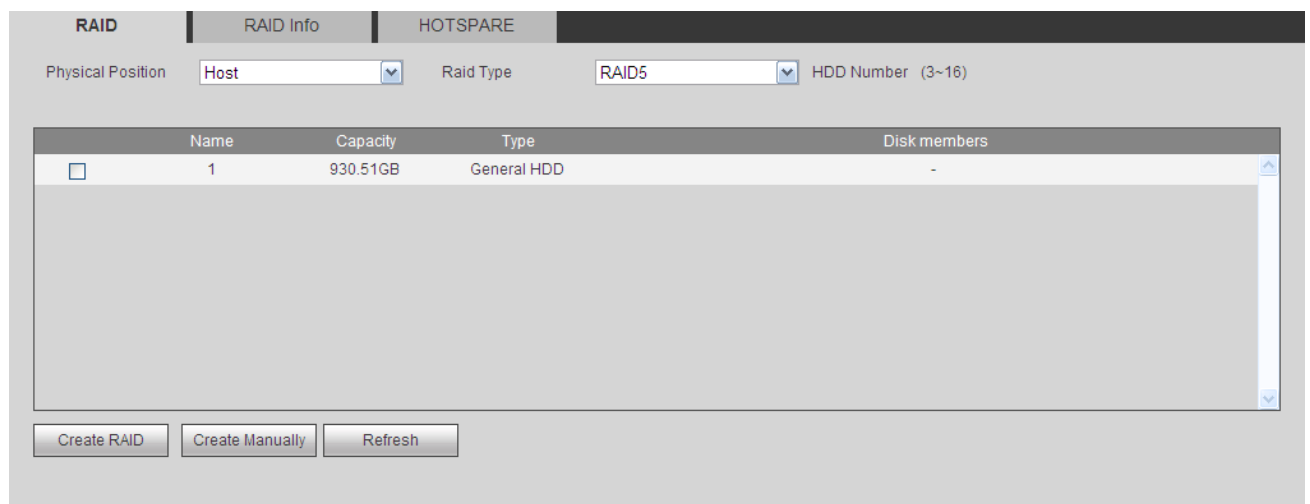

Figure 5-110

5.5.4.5.2 RAID Info

From main menu->Setup->Storage->RAID->RAID info, you can go to the following

interface. See Figure 5-111. Here you can view corresponding RAID information.



Figure 5-111

5.5.4.5.3 Hotspare disks

From main menu->Setup->Storage->RAID->Hotspare, you can see an interface shown as in Figure 5-112. The type includes two options:

- Global: It is global hotspare disk. When any RAID becomes degrading, it can replace and build the RAID.
- Local: It is local hotspare disk. When the specified RAID becomes degrading, it can replace and build the RAID.

Select a hot spare device and then click Delete button . Click Apply button to delete.

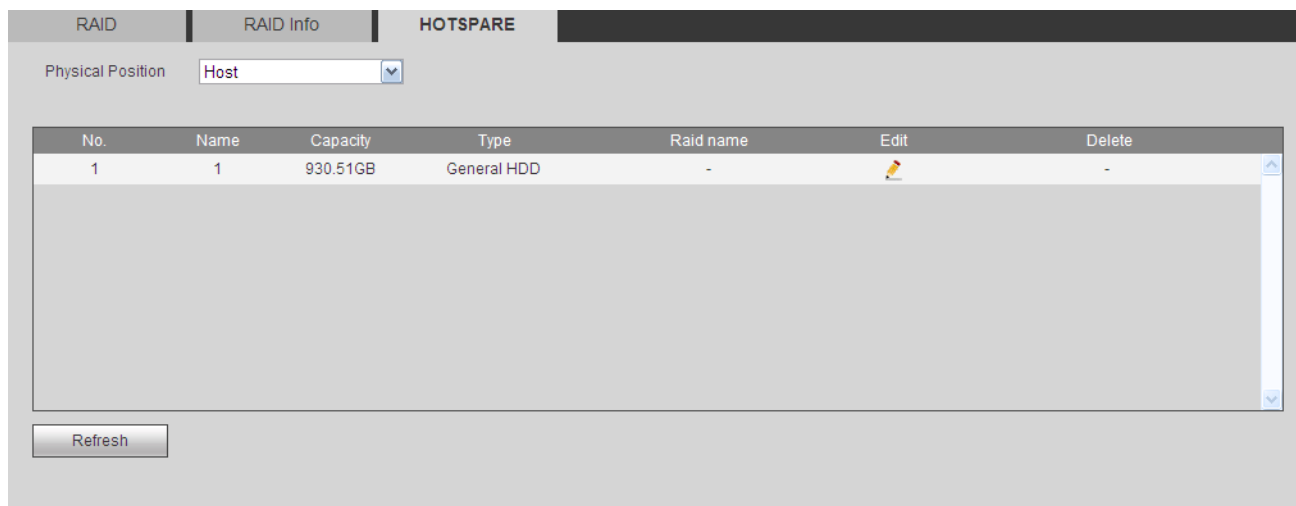

Figure 5-112

5.5.4.6 iSCSI

From main menu->Setup->Storage->iSCSI, you can see an interface shown as in Figure 5-113. Here you can set corresponding HDD group to save main stream.

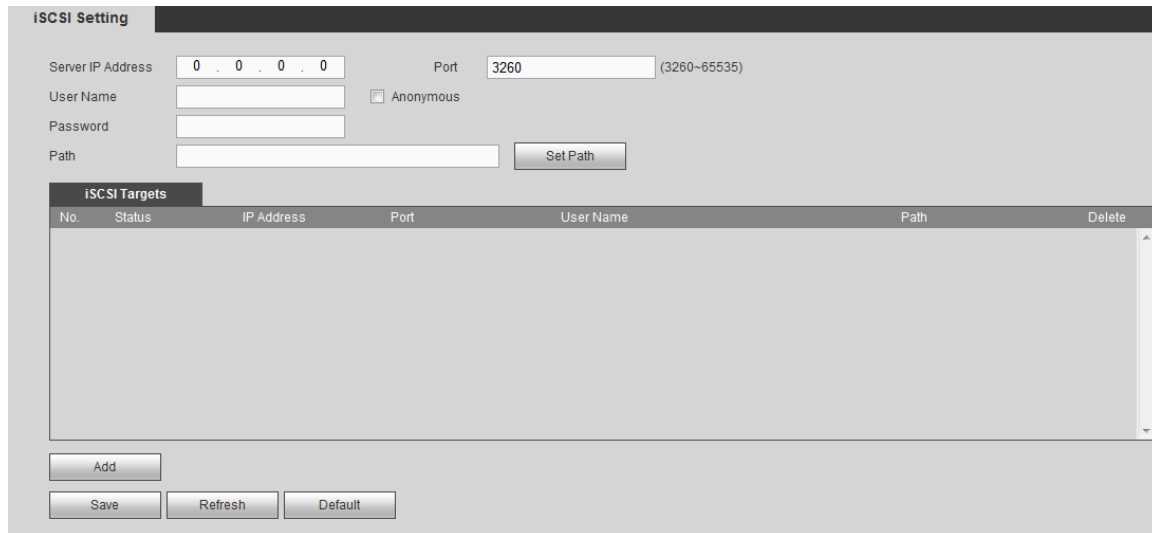

Figure 5-113

Check the box to enable iSCSI function and then input iSCSI server IP address and port. The default port number is 3260. Click Set path button, system pops up the path setup dialogue box. Please select the connected path and then click OK button. See Figure 5-114. Each path here stands for an iSCSI share disk. The path is already generated when it was created on the server.

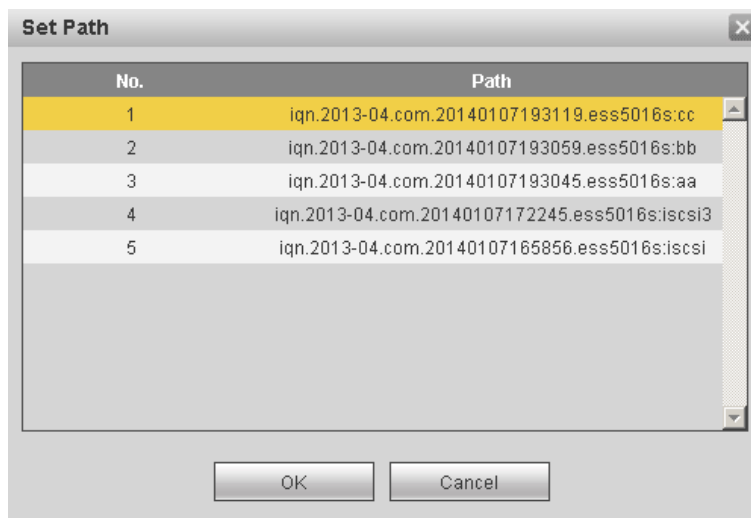

Figure 5-114

Input user name and password to set iSCSI path access right.

There are two situations:

- When you set the iSCSI server, you have set corresponding user name or password for a path. In this situation, you need to input user name or password to login.
- When you set the iSCSI server, you have not set the corresponding access right. In this situation, you can check the anonymous button or input customized user name.

Click add button, now you have added an iSCSI server. Click OK button, the setup is finish.

The interface is shown as in Figure 5-115.

Note:

- If you have not input a user name/password, or check the anonymous button, system pops up a dialogue box to prompt you that system is going to add anonymously. In this situation, once the iSCSI path has the access setup, you may not connect to the iSCSI server.
- Since the connection may take a while, please wait a moment and then click refresh button, once the status is shown as offline after you added.

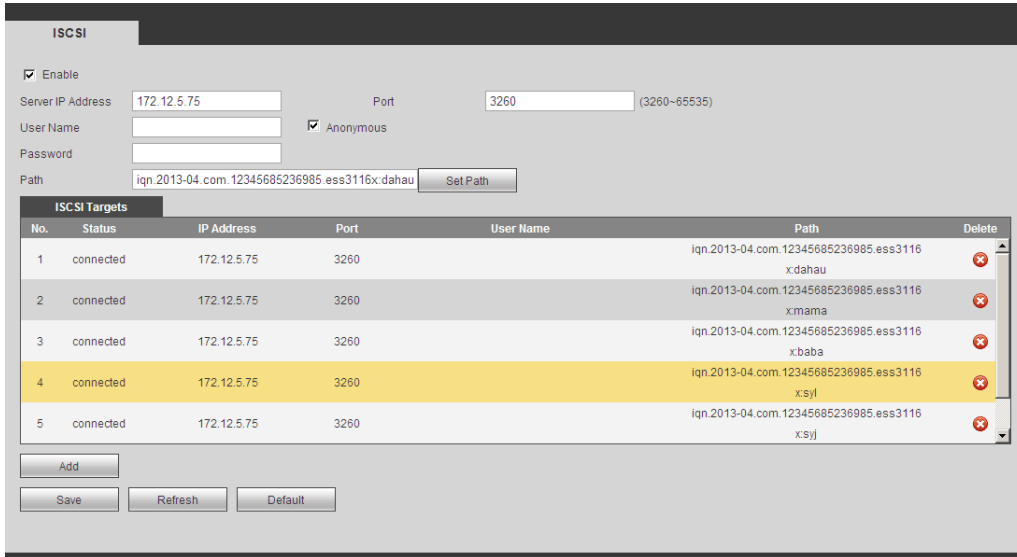

Figure 5-115

5.5.5 Setting

5.5.5.1 General

The general interface includes general, date/time and holiday setup.

5.5.5.1.1 General

From main menu->Setup->System->General->General, the general interface is shown as in Figure 5-116.

General	Date&Time	Holiday
Device Name	<input type="text" value="HCVR"/>	
Device No.	<input type="text" value="8"/>	
Language	<input type="text" value="ENGLISH"/>	
Video Standard	<input type="text" value="PAL"/>	
HDD Full	<input type="text" value="Overwrite"/>	
Pack Mode	<input type="text" value="Time Length"/>	<input type="text" value="60"/> Min.
Auto Logout	<input type="text" value="10"/>	Min. (0-60)
Startup Wizard	<input checked="" type="checkbox"/>	
Navigation Bar	<input type="checkbox"/>	
<input type="button" value="Save"/> <input type="button" value="Refresh"/> <input type="button" value="Default"/>		

Figure 5-116

Please refer to the following sheet for detailed information.

Parameter	Function
Device ID	It is to set device name.
Device No.	It is device channel number.
Language	You can select the language from the dropdown list. Please note the device needs to reboot to get the modification activated.
Video Standard	This is to display video standard such as PAL.
HDD full	Here is for you to select working mode when hard disk is full. There are two options: stop recording or rewrite. If current working HDD is overwritten or the current HDD is full while the next HDD is no empty, then system stops recording, If the current HDD is full and then next HDD is not empty, then system overwrites the previous files.
Pack duration	Here is for you to specify record duration. There are two ways for you to set. <ul style="list-style-type: none"> ● Time length: It is to pack according to time. The value ranges from 1 to 60 minutes. Default value is 60 minutes. ● File length: It is to pack according to file length. The default setup is 1024M. The value ranges from 128M to 2048M.
Auto logout	Here is for you to set auto logout interval once login user remains inactive for a specified time. Value ranges from 0 to 60 minutes.
IPC Time Sync	You can input an interval here to synchronize the DVR time and IPC time.
Navigation bar	Check the box here, system displays the navigation bar on the interface.
Startup wizard	Once you check the box here, system will go to the startup wizard directly when the system restarts the next time. Otherwise, it will go to the login interface.



5.5.5.1.2 Date and time

From main menu->Setup->System->General->Date and time, the date and time interface is shown as in Figure 5-117.

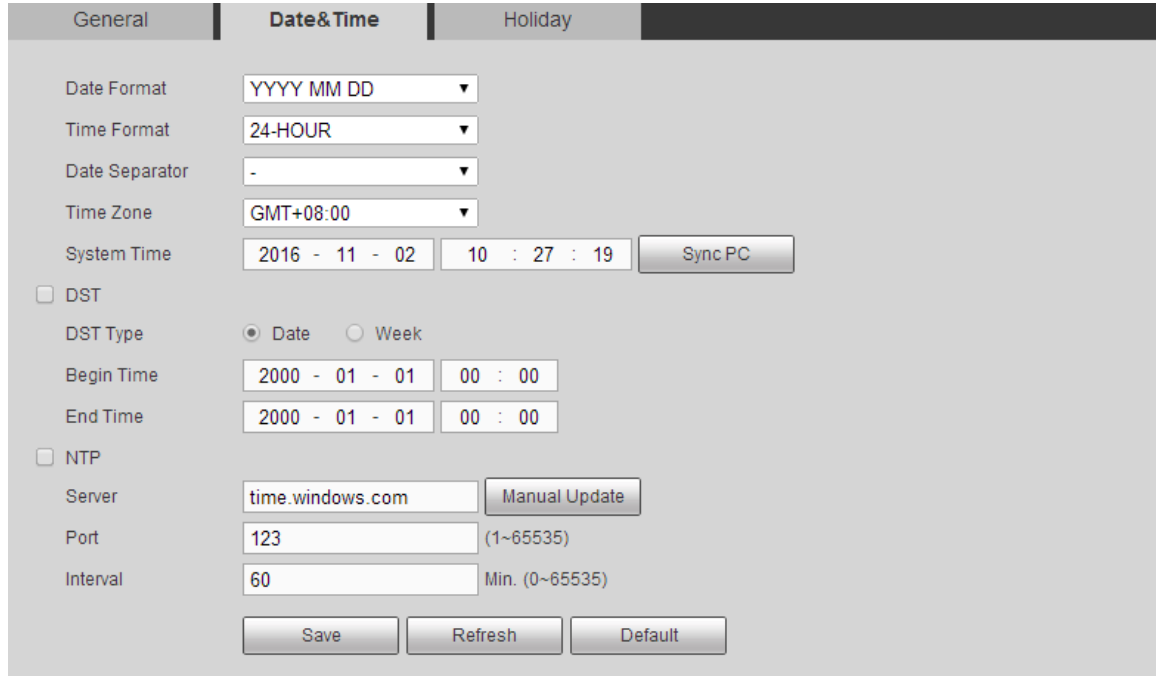

Figure 5-117

Please refer to the following sheet for detailed information.

Parameter	Function
Date format	Here you can select date format from the dropdown list.
Time Format	There are two options: 24-H and 12-H.
Time zone	The time zone of the device.
System time	It is to set system time. It becomes valid after you set.
Sync PC	You can click this button to save the system time as your PC current time.
DST	Here you can set day night save time begin time and end time. You can set according to the date format or according to the week format.
NTP	You can check the box to enable NTP function.
NTP server	<p>You can set the time server address.</p> <ul style="list-style-type: none"> ● Check the NTP box to enable this function. ● Host IP: Input the server IP that installed the NTP server. ● Manual update: Click it, you can sync DVR time with the NTP server manually. ● Port: System supports TCP transmission only. The port value is

	123. <ul style="list-style-type: none"> Interval: It is to set the sync time interval between the DVR and the NTP server. The value ranges from 0 to 65535 minutes.
Port	It is to set the time server port.
Interval	It is to set the sync periods between the device and the time server.

5.5.5.1.3 Holiday Setup

Holiday setup interface is shown as in Figure 5-118.

From main menu->Setup->System->General->Holiday, here you can click Add box to add a new holiday and then click Save button to save.

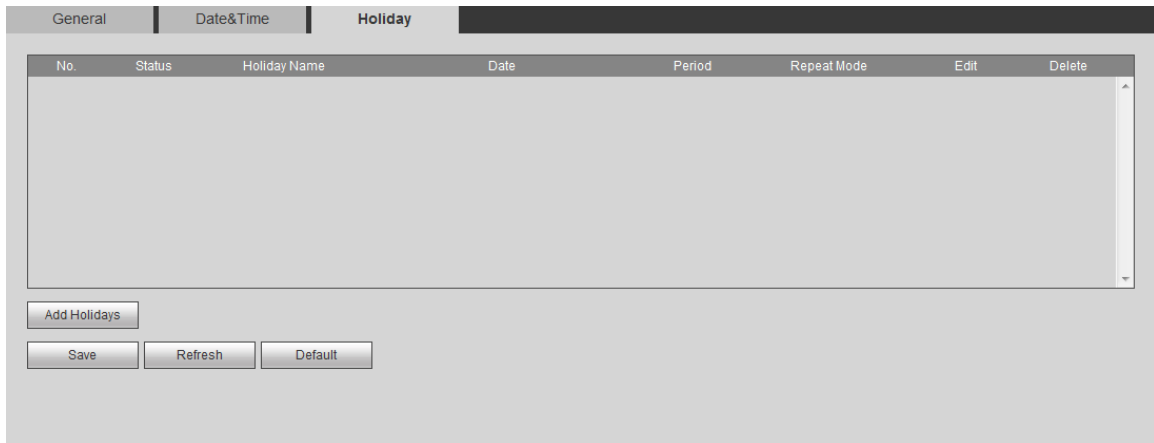

Figure 5-118

5.5.5.2 Display

Display interface includes GUI, TV adjust, Tour and zero-channel encoding.

5.5.5.2.1 Display

From main menu->Setup->System->Display->Display, here you can set background color and transparency level. See Figure 5-119.

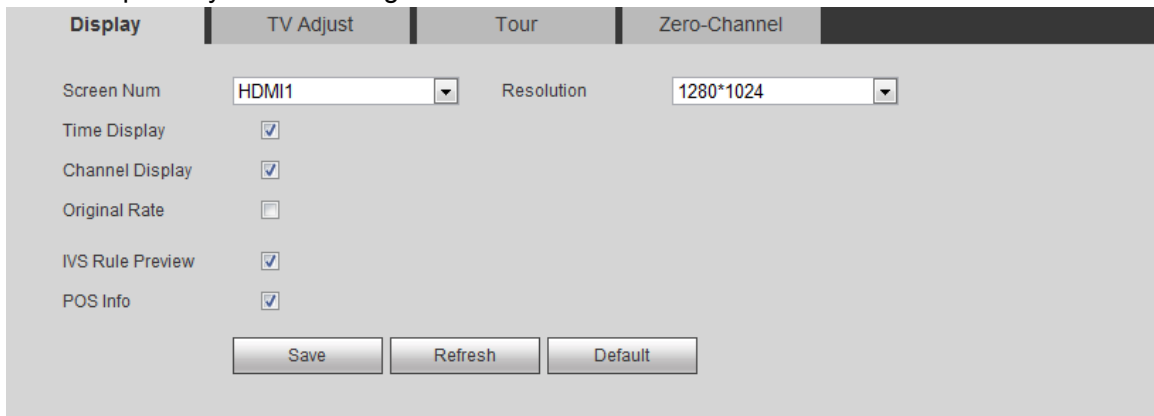

Figure 5-119

Please refer to the following sheet for detailed information.

Parameter	Function
Screen number	Please select a screen number from the dropdown list.

Resolution	<ul style="list-style-type: none"> ● System supports the following resolutions: 1920×1080,1280×1024,1280×720,1024×768,2560×1440,3840×2160@25fps,3840×2160@30fps. ● The default VGA/ HDMI1/HDMI2 resolution is 1280×1024. ● Please note the system needs to reboot to activate new setup. ● Right now, HDMI2 does not support 3840×2160@25fps, 3840×2160@30fps.
Transparency	Here is for you to adjust transparency. The value ranges from 128 to 255.
Time title/channel title	Check the box here, you can view system time and channel number on the monitor video.
Channel display	You can select to display channel name or not when system is playback.
Original rate	Check the box here, the video can be displayed at its actual size.
IVS rule preview	Check the box here, you can view IVS rule name on the preview window.
POS information	Check the box here; you can view POS information on the preview window.

5.5.5.2.2 TV Adjust

Note

This function is for some series product only.

It is to set TV output region.

From main menu->Setup->System->Display->TV adjust; you can see an interface shown as in Figure 5-120.

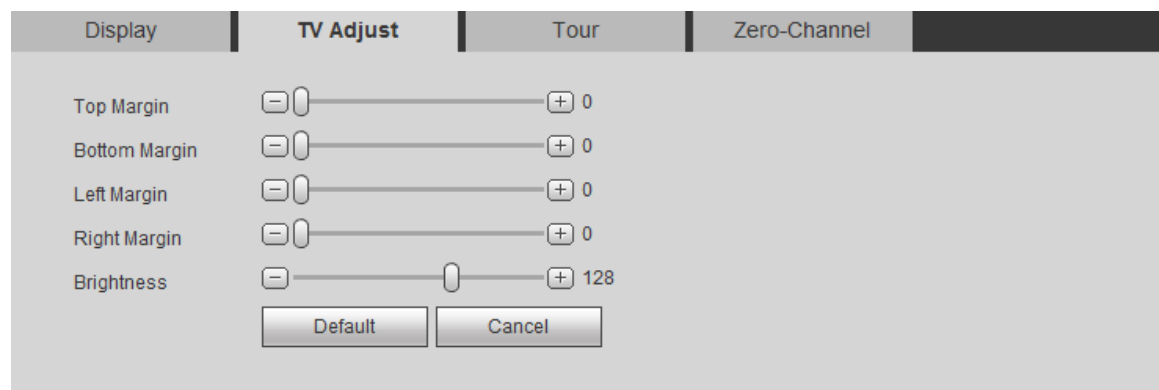

Figure 5-120

5.5.5.2.3 Tour

From main menu->Setup->System->Display->Tour, the tour interface is shown as in Figure 5-121. Here you can set tour interval, split mode, motion detect tour and alarm tour mode.

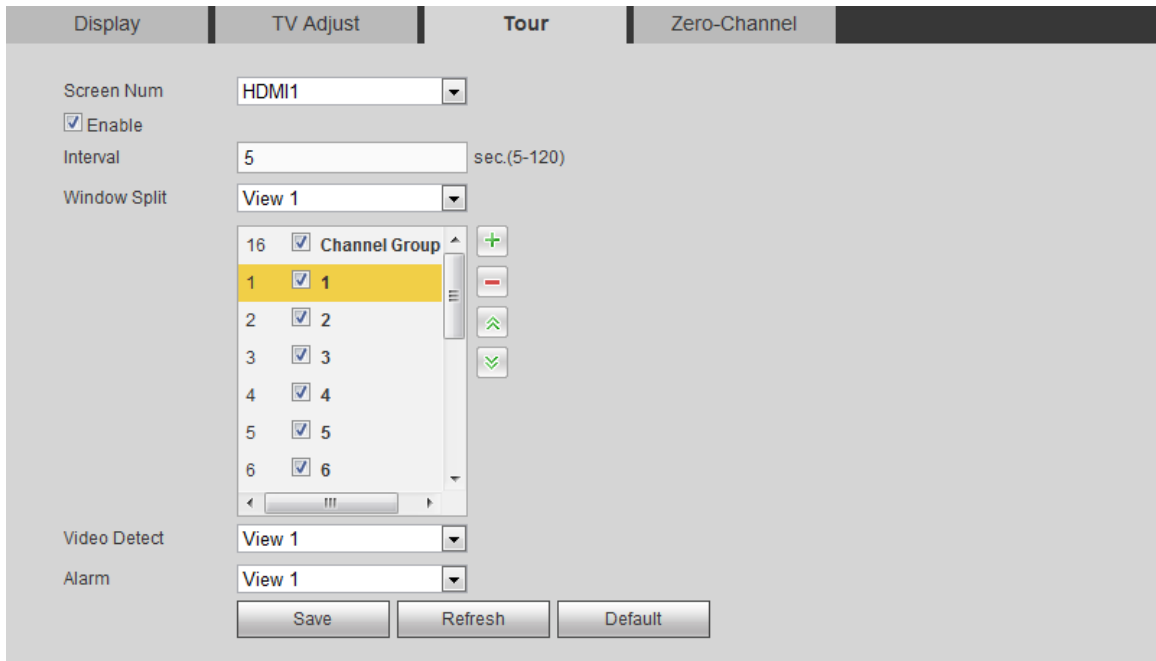

Figure 5-121

Please refer to the following sheet for detailed information.

Parameter	Function
Screen number	Please select a screen number from the dropdown list.
Enable tour	Check the box here to enable tour function.
Interval	Here is for you to adjust transparency. The value ranges from 5 to 120s. The default setup is 5s.
Split	Here you can set window mode and channel group. System can support 1/4/8/9/16/25/36-window according to device channel amount.
Motion tour/Alarm tour	Here you can set motion detect tour/alarm tour window mode. System supports 1/8-window now.

5.5.5.2.4 Zero-channel Encoding

From main menu->Setup->System->Display->Zero-channel encoding, the interface is shown as in Figure 5-122.

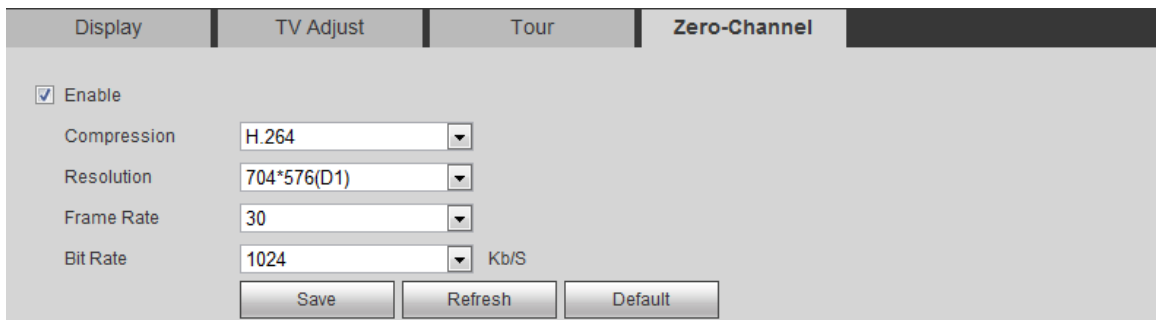

Figure 5-122

Please refer to the following sheet for detailed information.

Parameter	Function
Enable	This function is disabled by default. Check the box here to enable this function so that you can control the zero-channel encoding function at the WEB.
Compression	System default setup is H.264. You can set according to device capability.
Resolution	The resolution value may vary due to different device capabilities. Please select from the dropdown list.
Frame rate	The frame rate value may vary due to different device capabilities. Please select from the dropdown list.
Bit Rate	The default setup is 1024Kb/S. The bit rate value may vary due to different device capabilities and frame rate setups. Please select from the dropdown list.

5.5.5.3 Video Matrix

From main menu->Setup->System->Video matrix, the interface is shown as in Figure 5-123.

Here you can set video output channel and interval.

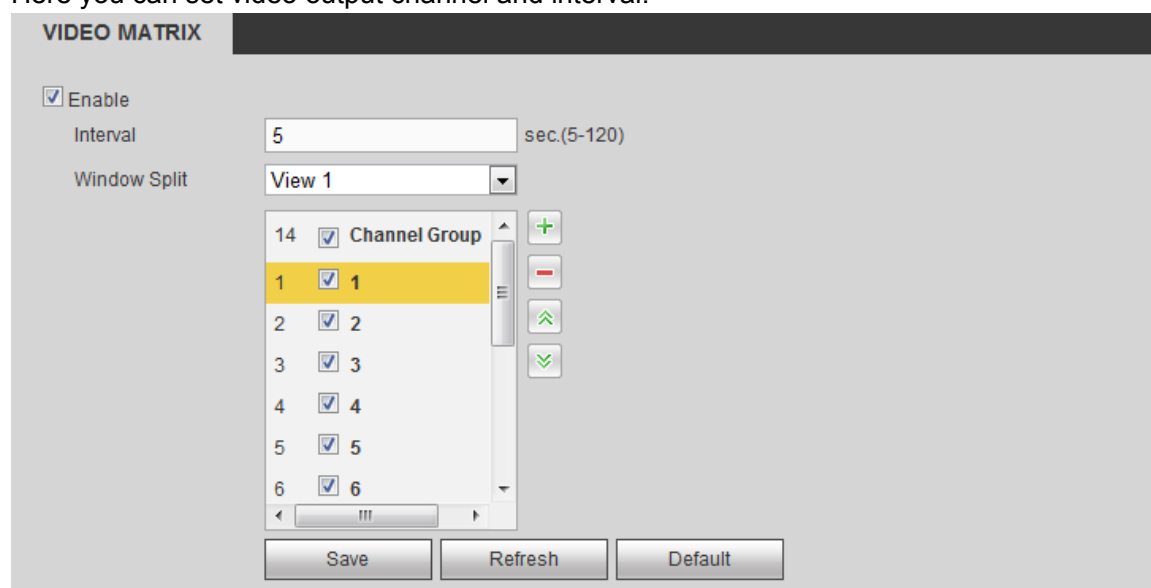





Figure 5-123

Please refer to the following sheet for detailed information.

Parameter	Function
Enable	Check the box here to enable this function.
Interval	It is to set the interval from current channel group to the next channel group.
Window split	Please select from the dropdown list. Please note the different series products support different window split mode.

Parameter	Function
Delete	Select a channel group and then click  to delete it.
Up/Down	Click  or  to adjust channel tour sequence.

Add channel group



Click , you can see system pops up the following dialogue box. See Figure 5-124. Please select the channels and then click OK button.



Figure 5-124

Delete channel group

Select a channel group and then click , you can delete it.



Modify channel group

Select a channel group and then double click, you can see the following interface. See Figure 5-125. You can change the setup and then click OK button.



Figure 5-125

Adjust channel group sequence.

Click  or  to change channel sequence.

5.5.5.4 RS232

From main menu->Setup->System->RS232, the RS232 interface is shown as in Figure 5-126.

Figure 5-126

Please refer to the following sheet for detailed information.

Parameter	Function
Protocol	Select the corresponding dome protocol. Default setup is console. <ul style="list-style-type: none"> ● Console is for you to use the COM or mini-end software to debug. ● The control keyboard is for you to control the device via the special keyboard. ● Transparent COM (adapter) is to directly connect to the PC to transfer data. Protocol COM is for card overlay function. ● Network keyboard is for you to use the special keyboard to control the device. ● PTZ matrix is to connect to the peripheral matrix control.
Baud Rate	Select the baud rate. Default setup is 115200.
Data Bit	The value ranges from 5 to 8. Default setup is 8.
Stop bit	There are three options: 1/1.5/2. Default setup is 1.
Parity	There are five options: none/odd/even/space/mark. Default setup is none.

5.5.5.5 PTZ

From main menu->Setup->System->PTZ, the PTZ interface is shown as in Figure 5-127 (local channel) and Figure 5-128 (remote channel).

Before setup, please check the following connections are right:

- PTZ and decoder connection is right. Decoder address setup is right.
- Decoder A (B) line connects with DVR A (B) line.

Click Save button after you complete setup, you can go back to the monitor interface to control speed dome.

PTZ

Channel: 1

PTZ Type: Local

Control Mode: HD-AVS

Protocol: HD-AVS

Address: 1

Baud Rate: 9600

Data Bit: 8

Stop Bit: 1

Parity: None

Copy Save Refresh Default

Figure 5-127

PTZ

Channel: 16

PTZ Type: Remote

Copy Save Refresh Default

Figure 5-128

Please refer to the following sheet for detailed information.

Parameter	Function
Channel	Select speed dome connected channel.
PTZ type	There are two types: local/remote. Please select local mode if you are connect RS485 cable to connect to the Speed dome (PTZ). Please select remote mode if you are connecting to the network PTZ camera.
Control mode	You can select control mode from the dropdown list. There are two options: Serial/HD AVS. For HD AVS series product, please select HD AVS. The control signal is sent to the PTZ via the coaxial cable. For the serial mode, the control signal is sent to the PTZ via the RS485 port.
Protocol	Please select protocol from the dropdown list.
Address	Set corresponding dome address. Default value is 1. Please note your setup here shall comply with your dome address; otherwise you can not control the speed dome.
Baud Rate	Select the dome baud rate. Default setup is 9600.
Data Bit	Default setup is 8. Please set according to the speed dome dial switch

Parameter	Function
	setup.
Stop bit	Default setup is 1. Please set according to the speed dome dial switch setup.
Parity	Default setup is none. Please set according to the speed dome dial switch setup.

5.5.5.6 POS

Note

- For the local-end, this function supports one-window display and playback only. For the Web, it supports multiple-window display and playback.
- This function is for the cashier of the supermarket and etc. The DVR can get the information from the POS and then overlay the txt information on the video.

Connect the DVR with the POS, the DVR can receive the POS information and overlay corresponding info on the video.

From main menu->Setting->System->POS, the interface is shown as below. See Figure 5-129.

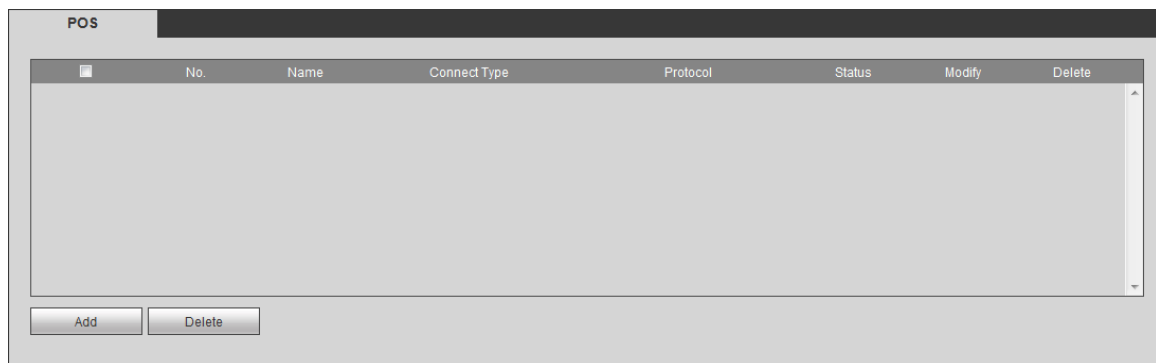

Figure 5-129

Click Add button, the interface is shown as below. See Figure 5-130.

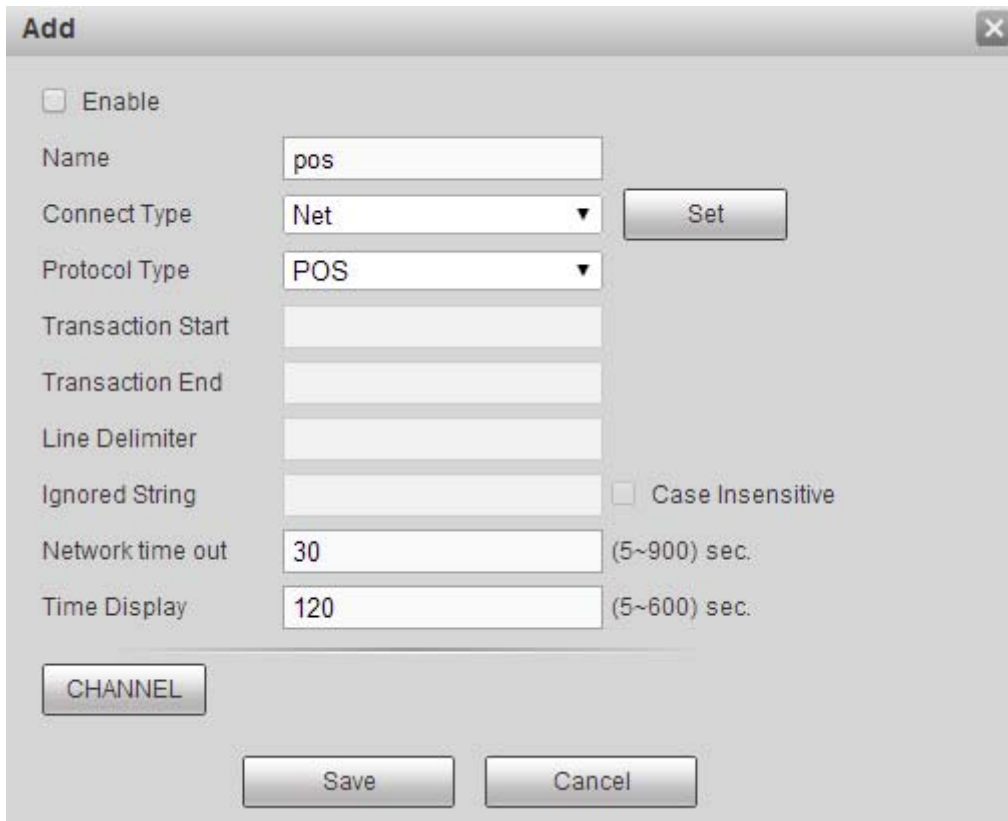

Figure 5-130

In Figure 5-130, click the Enable box to enable POS function and then input POS device name.

Please refer to the following sheet for detailed information.

Parameter	Function
Name	Input POS name. System max supports 63 English letters.
Connection type	This is for net mode only. Click Setup button, you can set source IP (POS IP address), port is the POS port. Destination IP is the DVR default Ethernet card IP, port is the POS port (read-only). See Figure 5-131.
Network time out:	If there is a network problem, DVR can wait for the specified time you set here to send out the POS information. Once the network time is out, DVR only send out current valid POS information when then network resumes normal.
Time display	It is to set the POS information displayed time on the video. If you set 5 seconds, then the POS information appears after 5 seconds display.
Channel Set:	Click it to go to Figure 5-132. Select a channel you want to overlay POS information and then click Save button

Note

- The POS device name shall be unique.
- POS device name max supports 63-digit.

Click Setup button after the connection mode, the interface is shown as in Figure 5-131. Here you can set source IP (POS device IP address) and source IP (DVR IP address).

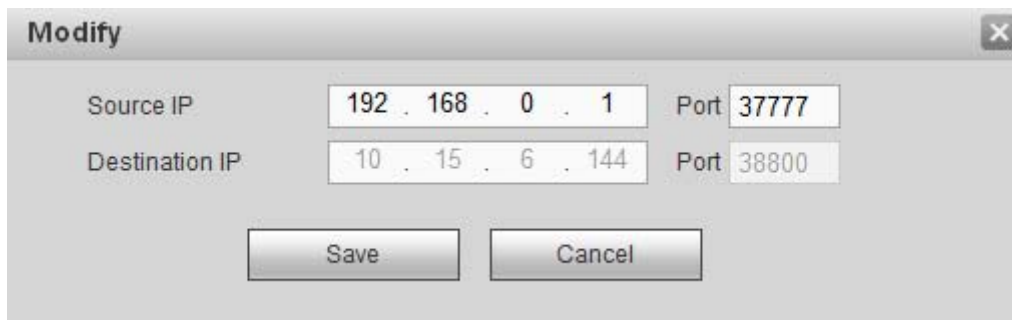

Figure 5-131

In Figure 5-130, click Channel button at the bottom of the interface, select a channel you want to overlay POS information and then click Save button. See Figure 5-132.



Figure 5-132

5.5.5.7 Voice

The audio function is to manage audio files and set schedule play function. It is to realize audio broadcast activation function.

5.5.5.7.1 File List

From main menu->Setup->System->Voice->File list, here you can add audio file, or delete audio file. See Figure 5-133.

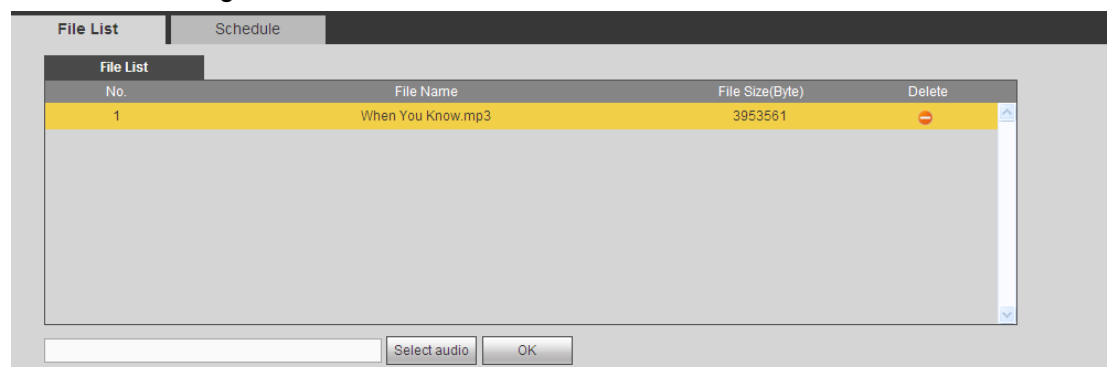

Figure 5-133

Click Add button, you can add audio file and import the audio file via the local computer. See Figure 5-134.

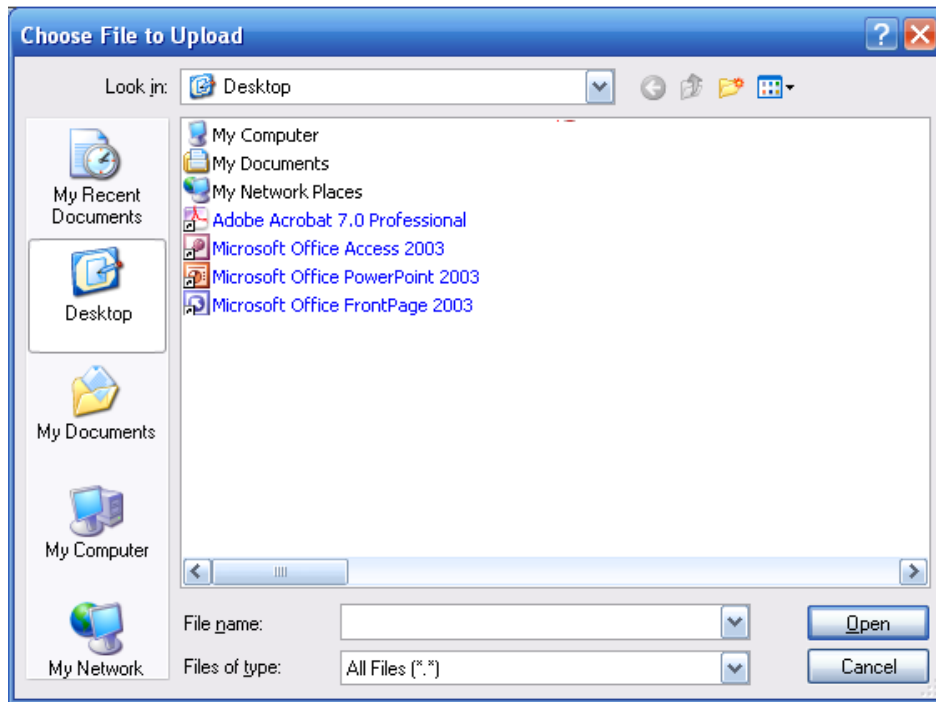

Figure 5-134

5.5.5.7.2 Schedule

It is to set schedule broadcast function. You can play the different audio files in the specified periods.

From main menu->Setup->System->Voice->.Schedule, you can see the following interface. See Figure 5-135.

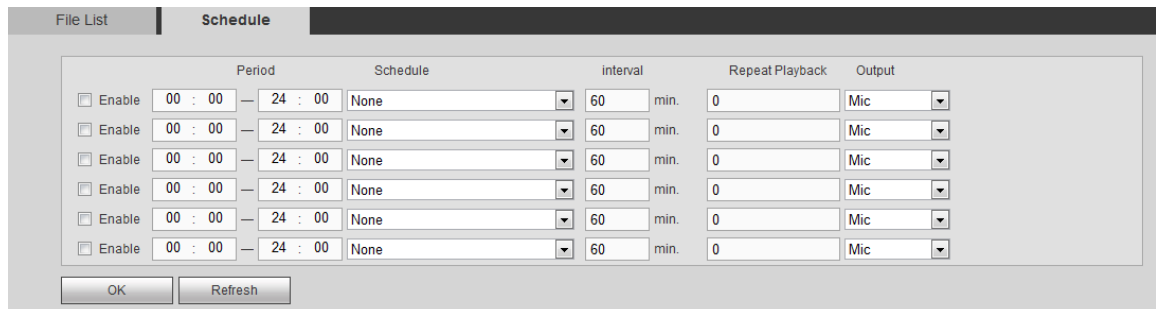

Figure 5-135

Please refer to the following sheet for detailed information.

Parameter	Function
Period	There are six periods. Check the box to enable current setup.
Repeat	It is to set audio file repeat times in the specified period.
Interval	It is the audio file repeated interval in the specified period.
Output	There are two options: MIC (default)/audio. When reuse the MIC port

Parameter	Function
port	and bidirectional talk port, the bidirectional port has the higher priority. Please note some series product does not support audio function.

Note

- The audio file end time depends on the audio file size and the interval setup.
- Priority: Bidirectional talk>Event trigger alarm>Trial listening>Audio schedule broadcast.

5.5.5.8 Account

Note:

- For the user name, the string max length is 31-byte, and for the user group, the string max length is 15-byte. The backspace in front of or at the back of the string is invalid. There can be backspace in the middle. The string includes the valid character, letter, number, underline, subtraction sign, and dot.
- The default user amount is 64 and the default group amount is 20. System account adopts two-level management: group and user. No limit to group or user amount.
- For group or user management, there are two levels: admin and user. The user name shall be unique and one user shall only belong to one group.

5.5.5.8.1 User

From main menu->Setup->System->Account->User, in this interface you can add/remove user and modify user name. See Figure 5-136.

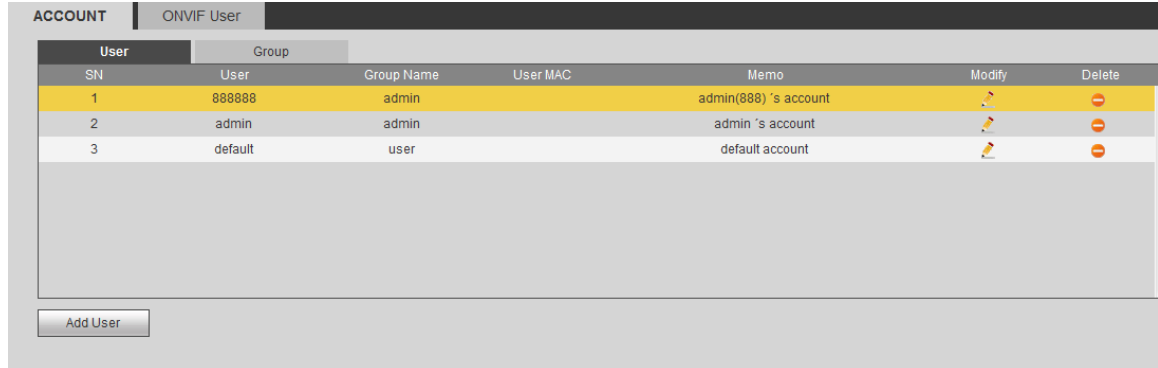

Figure 5-136

Add user: It is to add a name to group and set the user rights. See Figure 5-137.

There are three default users: admin (password: admin)/888888(password: 888888) and hidden user “default”.

Hidden user “default” is for system interior use only and can not be deleted. When there is no login user, hidden user “default” automatically login. You can set some rights such as monitor for this user so that you can view some channel view without login.

Here you can input the user name and password and then select one group for current user.

Please note the user rights shall not exceed the group right setup.

For convenient setup, please make sure the general user has the lower rights setup than the admin.

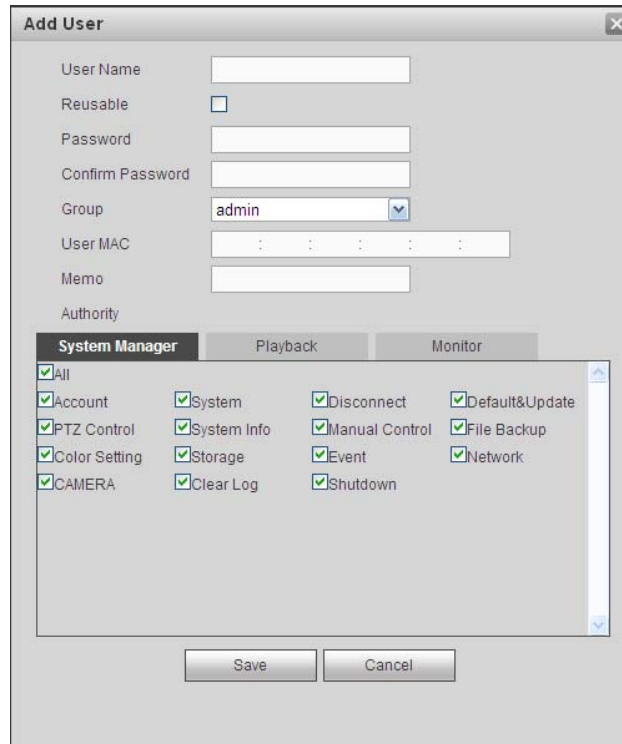

Figure 5-137

Modify user

It is to modify the user property, belonging group, password and rights. See Figure 5-138.

Modify password

It is to modify the user password. You need to input the old password and then input the new password twice to confirm the new setup. Please click the OK button to save.

Please note, the password ranges from 1-digit to 32-digit. The space at the front or the end is null. The password can contain the space in the middle. For the user of the account rights, he can modify the password of other users.

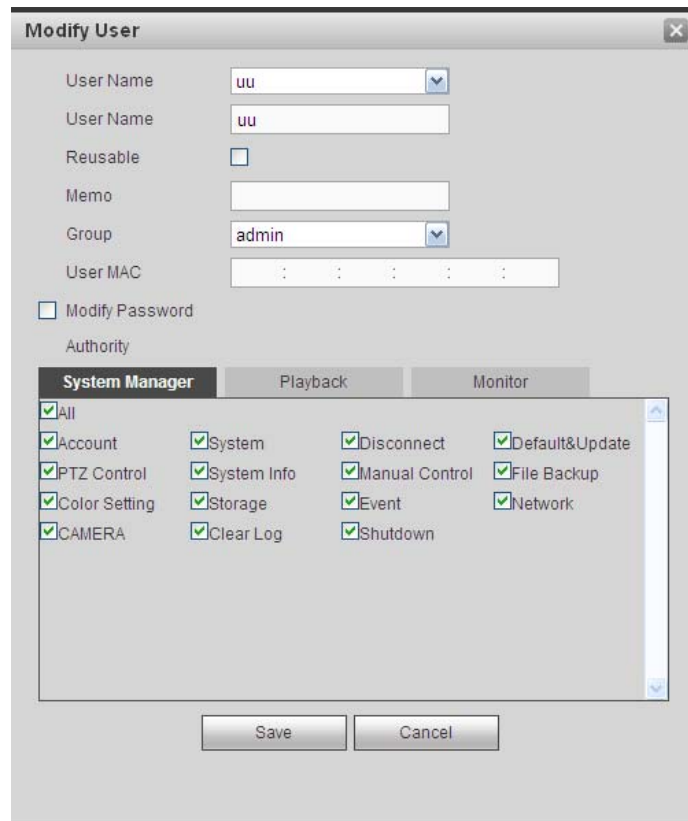

Figure 5-138

5.5.5.8.2 Group

The group management interface can add/remove group, modify group password and etc. From main menu->Setup->System->Account->Group, the interface is shown as in Figure 5-139.

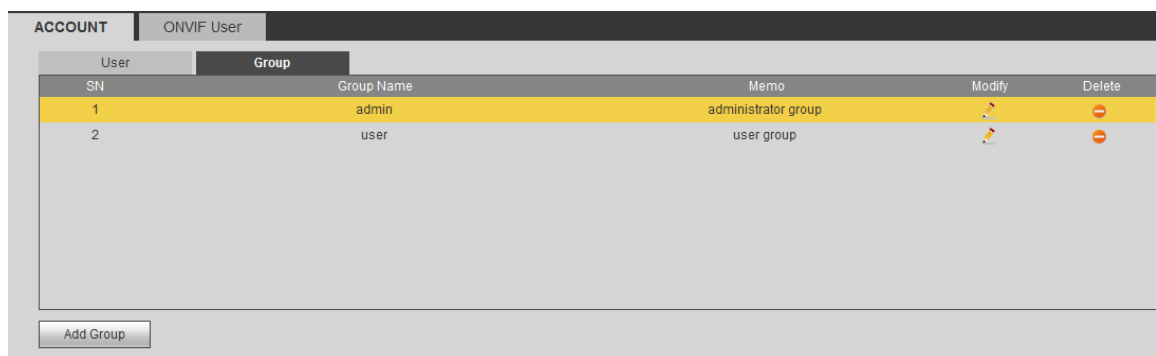

Figure 5-139

Add group: It is to add group and set its corresponding rights. See Figure 5-140. Please input the group name and then check the box to select the corresponding rights. It includes: shutdown/reboot device, live view, record control, PTZ control and etc.

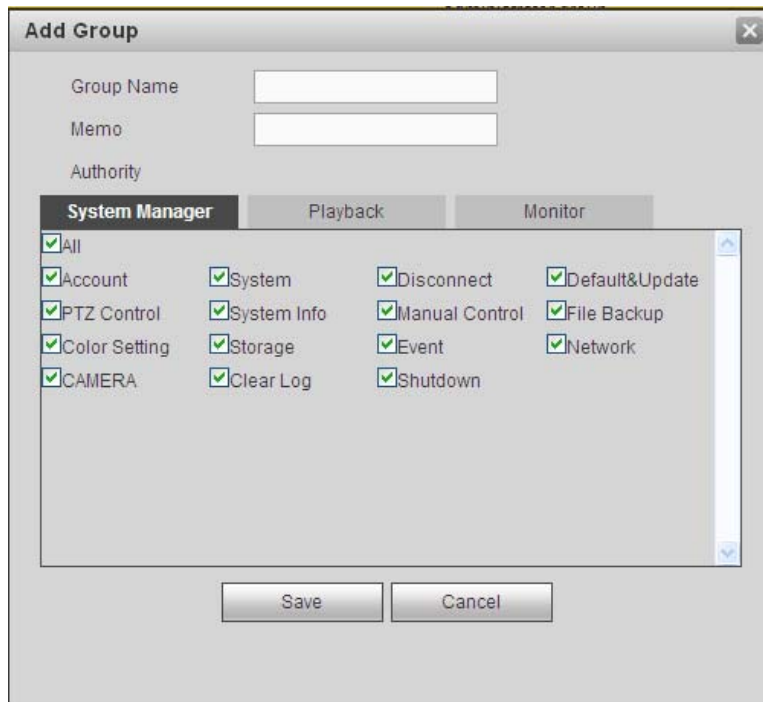

Figure 5-140

Modify group

Click the modify group button, you can see an interface is shown as in Figure 5-141. Here you can modify group information such as remarks and rights.

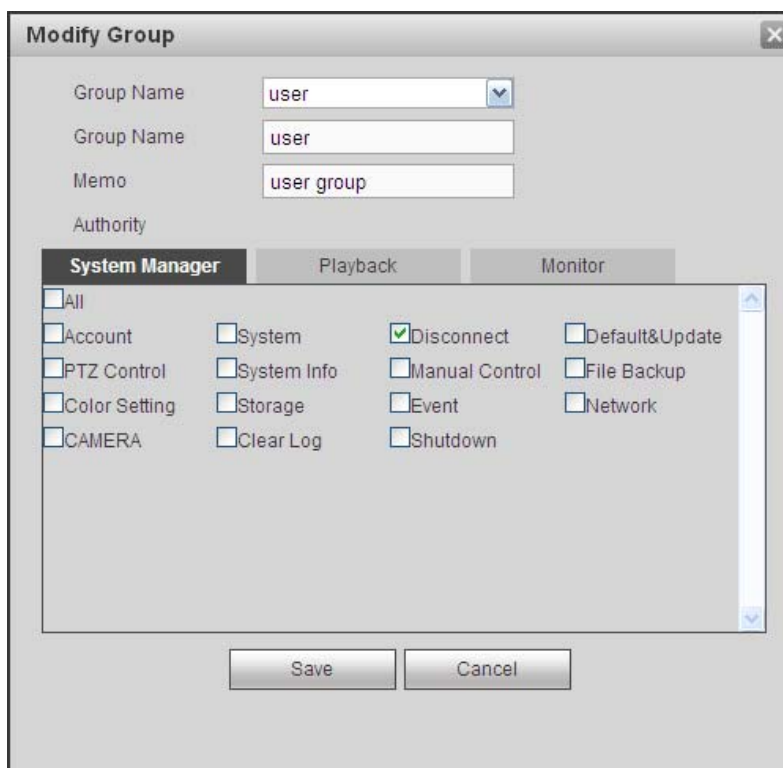

Figure 5-141

When the camera from the third party is connected with the DVR via the ONVIF user, please use the verified ONVIF account to connect to the DVR. From main menu->Setting->System->Account->ONVIF User, you can go to ONVIF user interface See Figure 5-142.

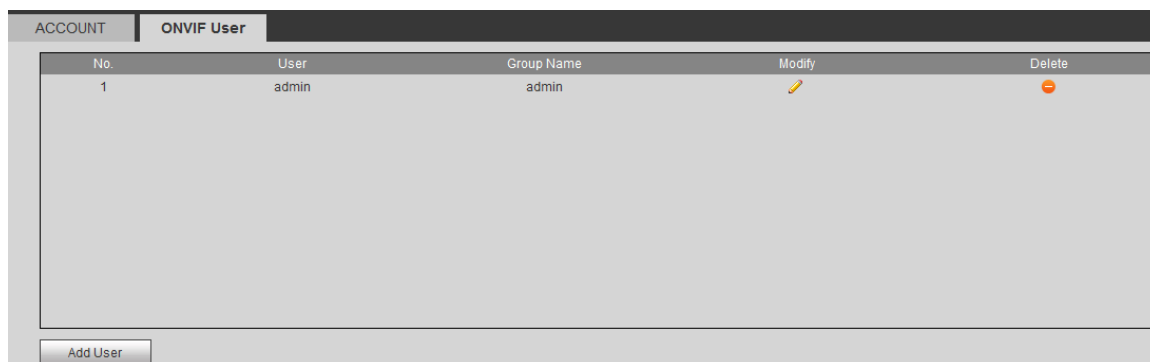

Figure 5-142

Click Add user button, you can see the following interface. See Figure 5-143.

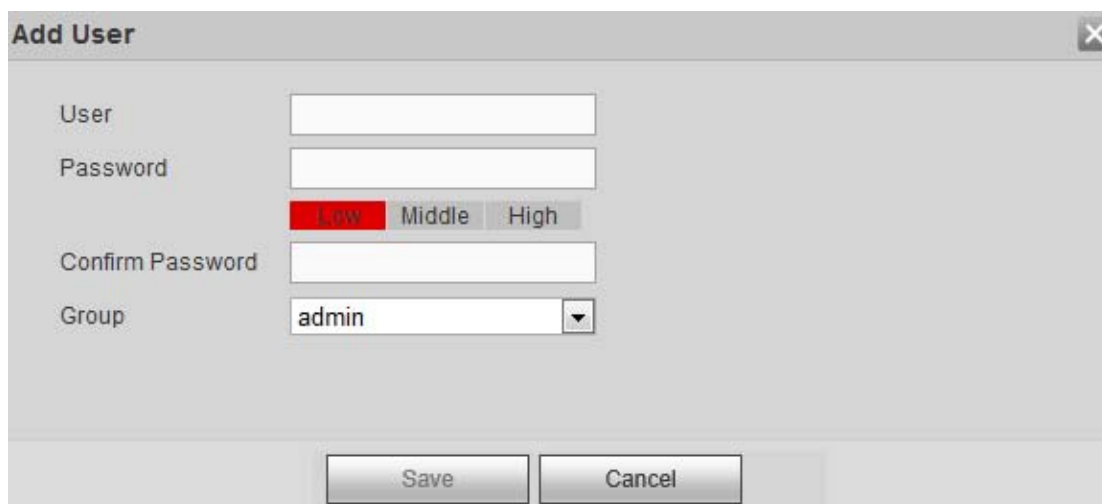

Figure 5-143

Please set user name, password and then select group from the dropdown list. Click Save to complete setup.

Tips

Click to change user information, click to delete current user.

5.5.5.9 Auto maintain

From main menu->Setting->System->Auto maintain, the interface is shown as in Figure 5-144.

Here you can select auto reboot and auto delete old files interval from the dropdown list. If you want to use the auto delete old files function, you need to set the file period. Click Manual reboot button, you can restart device manually.

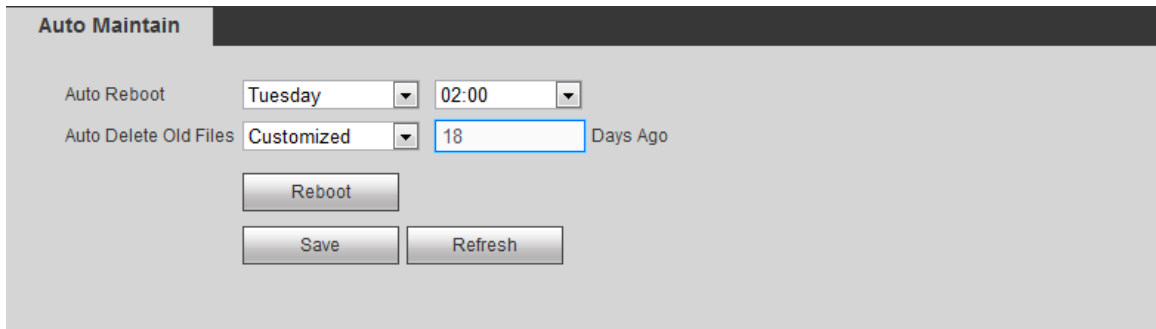

Figure 5-144

5.5.5.10 Import/Export

From main menu->Setting->System->Import/Export, the interface is shown as in Figure 5-145.



Figure 5-145

Please refer to the following sheet for detailed information.

Parameter	Function
Import	It is to import the local setup files to the system.
Export	It is to export the corresponding WEB setup to your local PC.

5.5.5.11 Default

From main menu->Setting->System->Default, the default setup interface is shown as in Figure 5-146.

Here you can select Channel/Network/Event/Storage/System. Or you can check the All box to select all items.

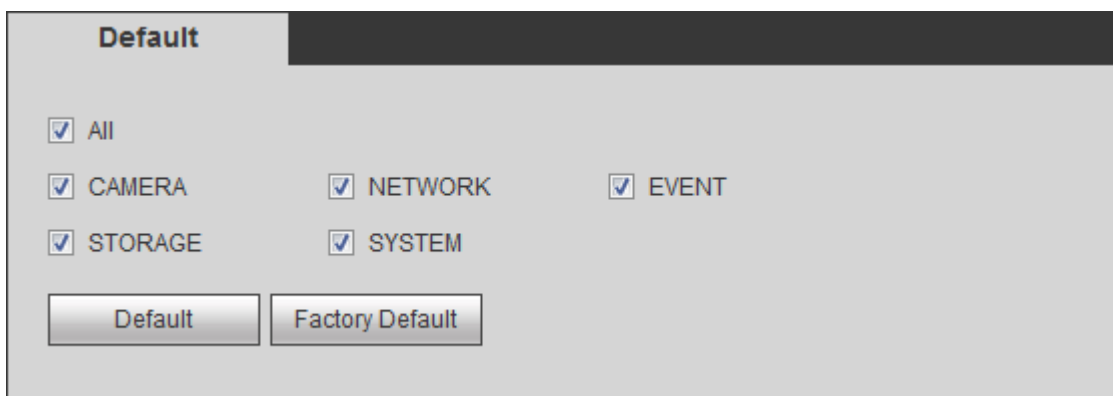

Figure 5-146

5.5.5.12 Upgrade

From main menu->Setting->System->Upgrade, the upgrade interface is shown as in Figure 5-147.

Please select the upgrade file and then click the update button to begin update. Please note the file name shall be as *.bin. During the upgrade process, do not unplug the power cable, network cable, or shutdown the device.

Important

Improper upgrade program may result in device malfunction!

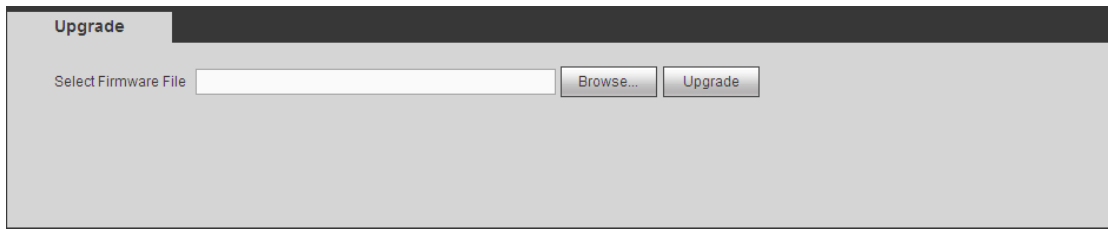

Figure 5-147

5.6 Playback

Click Playback button, you can see an interface is shown as in Figure 5-148.

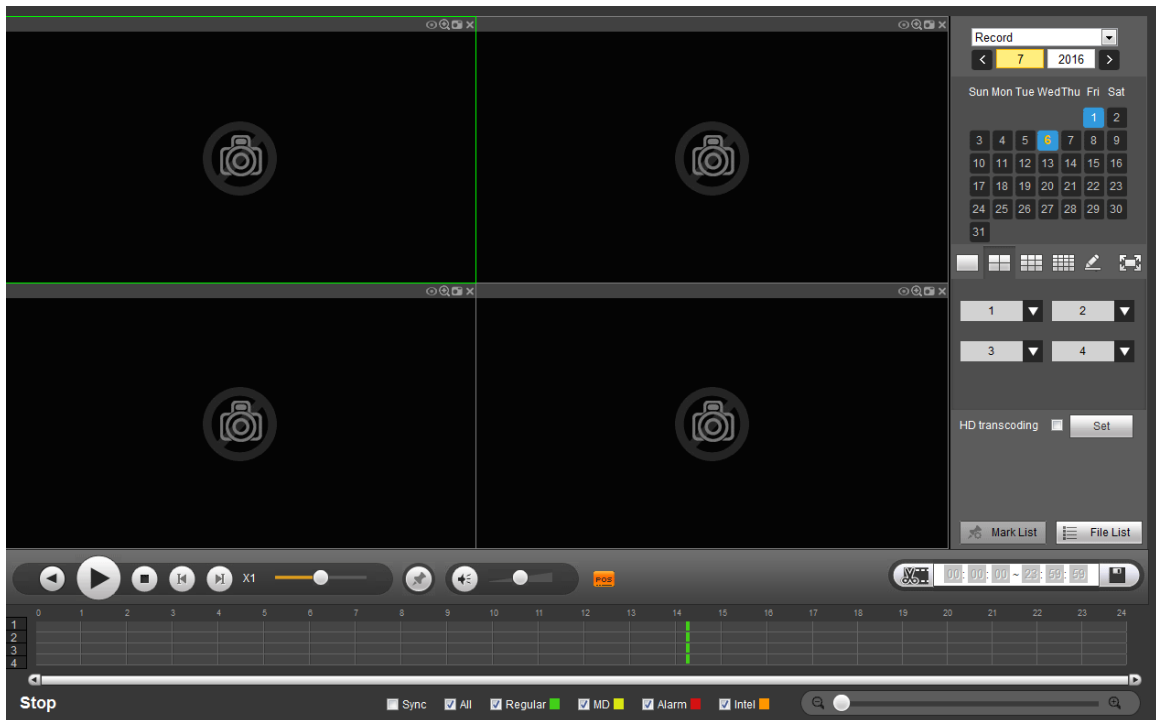

Figure 5-148

5.6.1 Search Record

Please set record type, record date, window display mode and channel name.

- Select Date

You can click the date on the right pane to select the date. The green highlighted date is

system current date and the blue highlighted date means it has record files.

- Window Split

Select window split mode. Click  to display in full screen. Click ESC button to exit. See Figure 5-149.

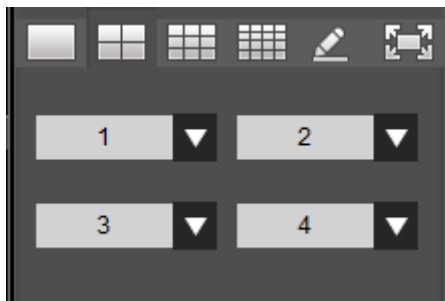

Figure 5-149

- Customized playback

Click , you can see the following interface. See Figure 5-150.

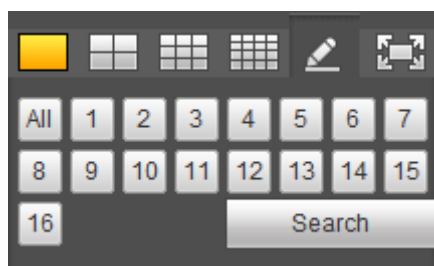
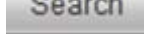



Figure 5-150

Now you can select one or more channel(s) and then click  to search record(s).

System supports one or more channels. The window split mode can auto adjust according to the channel amount. System max supports 16-split.

Click  button to select all channels at the same time.

Click , system begins playback.

- Select Channel

1~n(n depends on your product channel amount) means main stream and A1~An ((n depends on your product channel amount)) means sub stream.

- HD Transcoding

Note

This function is for some series product only.

When the bandwidth is limited, you can use this function to transfer the HD bit stream to the specified lower resolution and then playback. It is to reduce network load. In Figure 5-148, select the playback period and then select playback mode and channel(s). Check the box to enable HD transcoding function and then click the Set button; you can see the following interface. See Figure 5-151. Please select the resolution, frame rate, bit rate and then click the OK button.

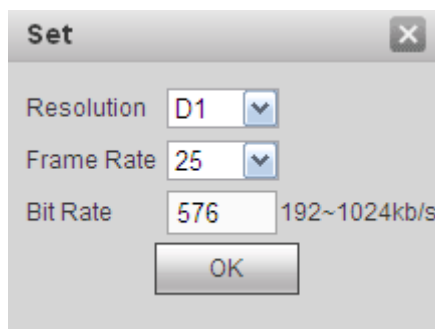

Figure 5-151

- Select Record Type

Please note some series product supports intelligent record. Check the corresponding box to select record type. See Figure 5-152.



Figure 5-152

- POS

In one-window playback mode, click  you can hide or display POS information.

- File clip

It is to clip some footages to save in the USB device or peripheral device. The interface is shown as in Figure 5-153.



Figure 5-153

Select a file first and then click  to playback.

Click  and there are two ways for you to set start time and end time See Figure 5-154.

- ✧ You can input start time and end time at the text column.
- ✧ Drag the two triangles icons at the time bar to set start time and end time.

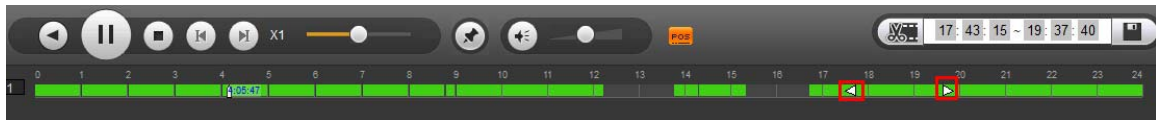



Figure 5-154

Click  to save the file.

The file will be saved at the path you set in chapter 5.5.1.3.4 (main menu->Setup->Camera->Encode->Path).

Note

- Clip function is for one-channel/multiple-channel.
- Max save 1024 files at the same time.

5.6.2 Mark Playback

Please make sure your purchased device support this function. You can use this function only if you can see the mark playback icon on the Search interface.

When you are playback record, you can mark the record when there is important information. After playback, you can use time or the mark key words to search corresponding record and then play. It is very easy for you to get the important video information.

- Add Mark

When system is playback, click Mark button , you can go to the following interface. See Figure 5-155.

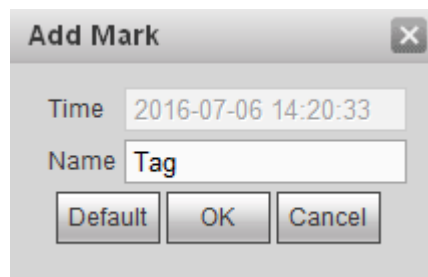

Figure 5-155

Input a name and then click OK button. You can view current file in the mark file list.

- Playback Mark

During 1-window playback mode, click Mark file list button, you can go to mark file list interface. Double click one mark file, you can begin playback from the mark time. See Figure 5-156.

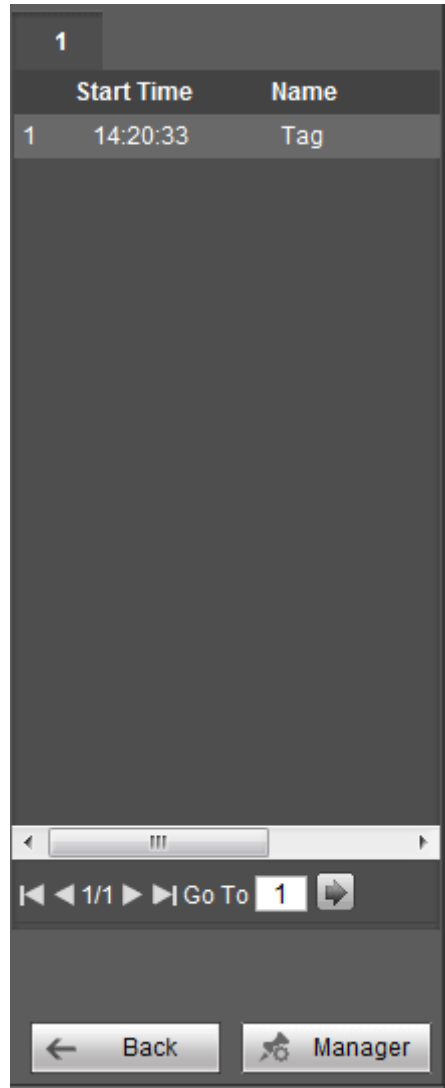

Figure 5-156

- Play before mark time

Here you can set to begin playback from previous N seconds of the mark time.

Note

Usually, system can playbacks previous N seconds record if there is such kind of record file. Otherwise, system playbacks from the previous X seconds when there is such as kind of record.

- Mark Manager

Click the mark manager button in Figure 5-156; you can go to Mark Manager interface. See Figure 5-157. System can manage all the record mark information of current channel by default. You can view all mark information of current channel by time.

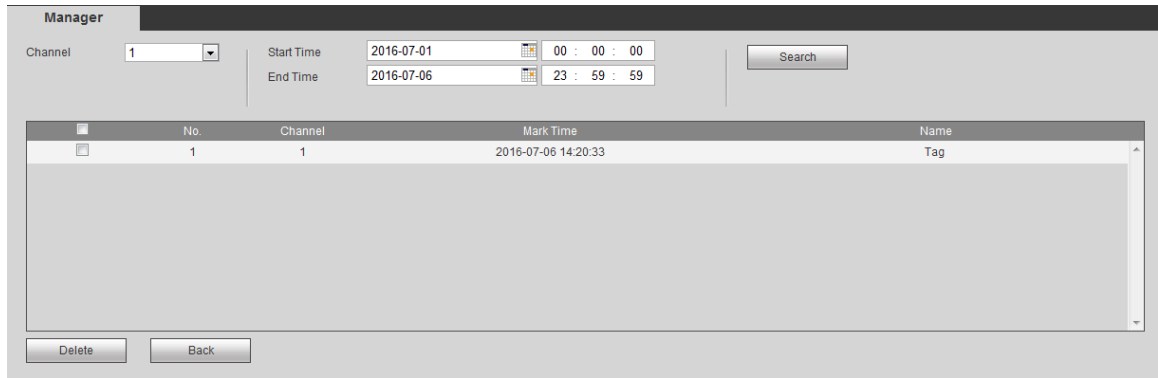

Figure 5-157

- **Modify**

Double click one mark information item, you can see system pops up a dialogue box for you to change mark information. You can only change mark name here.

- **Delete**

Here you can check the mark information item you want to delete and then click Delete button, you can remove one mark item. .

Note

- After you go to the mark management interface, system needs to pause current playback. System resume playback after you exit mark management interface.
- If the mark file you want to playback has been removed, system begins playback from the first file in the list.

5.6.3 Splice Playback

For the large record file, you can use splice playback function to play the same file in several sections at the same time. It is very convenient for you to find the video footages you desire.

On the main menu, select splice playback from the dropdown list, you can go to the Figure 5-158.

On the right pane, set channel, date, split mode. The splice playback interface is shown as below. Each section has a small triangle; you can adjust it to set time.

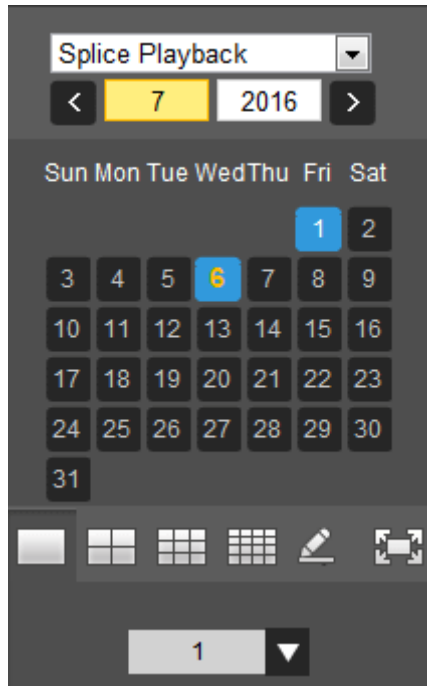

Figure 5-158

Note

Select split mode, so that the record can be spliced in several sections.

Select splice file.

- Click Playback, system playbacks from the first of current date by default.
- Click time bar, system playbacks from the time you click.

Note

- The splice playback is for 1-window playback mode.
- System supports 1/4/8/16-splice mode. Slight different may be found here. The 4-channel series product supports 4-splice mode. The 8-channel series product support 8-splice mode. The 16-channel or higher series product supports 16-splice mode.
- The min period of each section is 5 minutes. For the record is less than 20 minutes, if you select 4-split mode (or more than 4-split mode), system can auto adjust so that the each section period is 5 minutes. In this situation, some channel may have no video.

5.6.4 File List

Click File list button, you can see the corresponding file(s) in the list. See Figure 5-159.

File type includes: R=regular alarm. A=external alarm, M=Motion detect alarm, Intel-intelligent alarm.

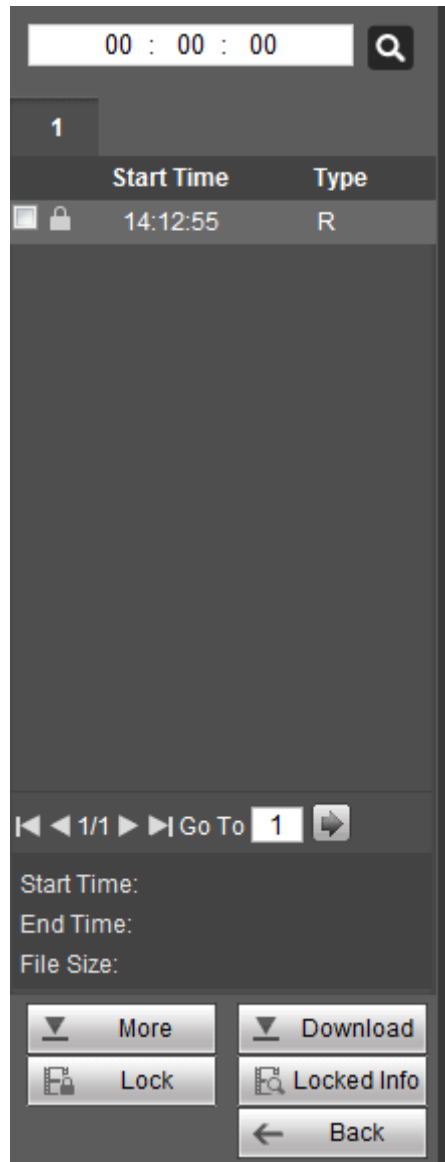

Figure 5-159

5.6.5 Playback

Select a file you want to play and then click Play button, system can begin playback. You can select to playback in full-screen. Please note for one channel, system can not playback and download at the same time. You can use the playback control bar to implement various operations such as play, pause, stop, slow play, fast play and etc.

5.6.6 Download

Select the file(s) you want to download and then click download button, you can see an interface shown as in Figure 5-160. The Download button becomes Stop button and there is a process bar for your reference. Please go to you default file saved path to view the files.



Figure 5-160

5.6.7 Load more

It is for you to search record or picture. You can select record channel, record type and record time to download. Or you can use watermark function to verify file.

5.6.7.1 Download By File

Select channel, record type, bit stream type and then input start time and end time. Click Search button, the download by file interface is shown as in Figure 5-161.

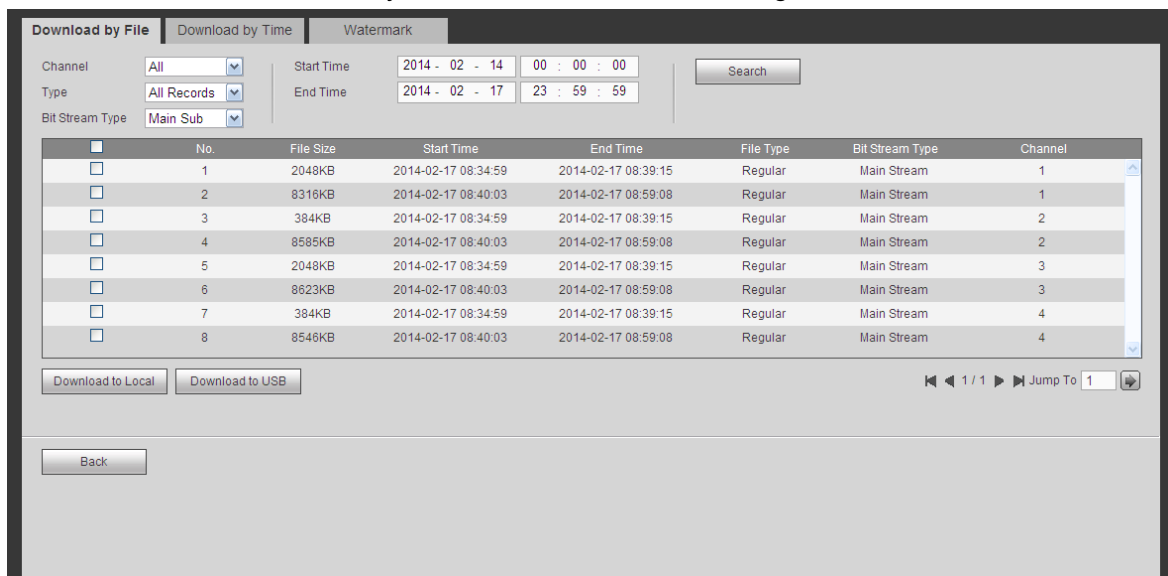

Figure 5-161

Check the file(s) you want to download and there are two options for you to save the file(s).

- Download to local

Click Download to local, system pops up the following interface for you to set record format and saved path. See Figure 5-162.

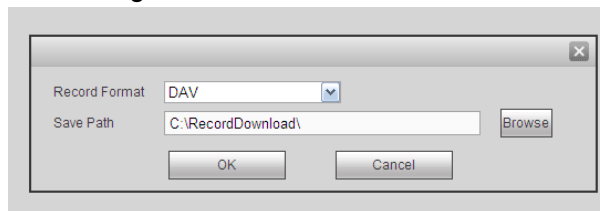

Figure 5-162

You can click OK to download and view the download process. After the download operation, you can see corresponding dialog box.

- Download to USB

Connect the corresponding peripheral device, and then click Download to USB button, you can see the following interface. See Figure 5-163.

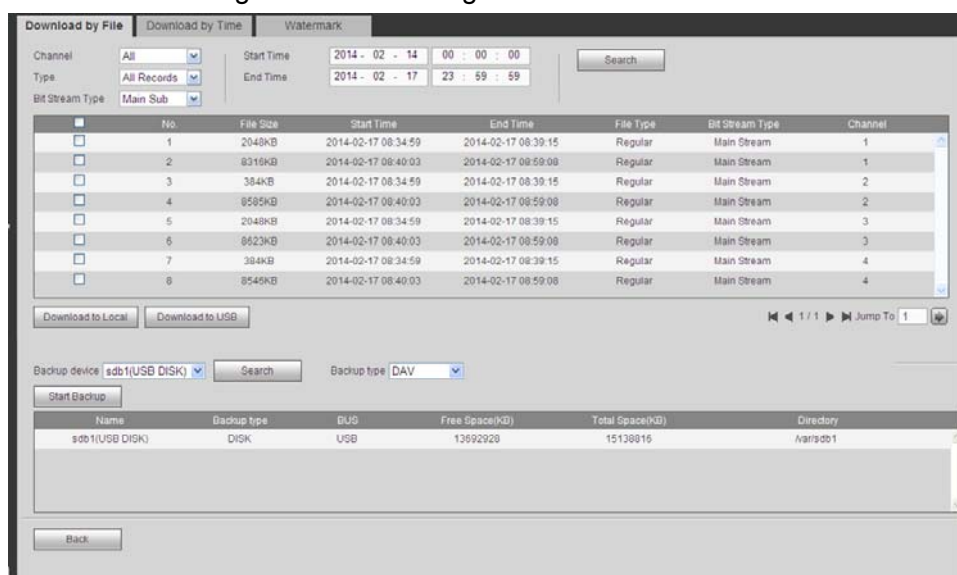

Figure 5-163

Select Backup device and backup type first and then click Start backup button.

After the download operation, you can see corresponding dialogue box.

5.6.7.2 Download by Time

Select channel, bit stream type, start time and end time.

Click Download to Local button, you can see download by time interface is shown as in Figure 5-164.

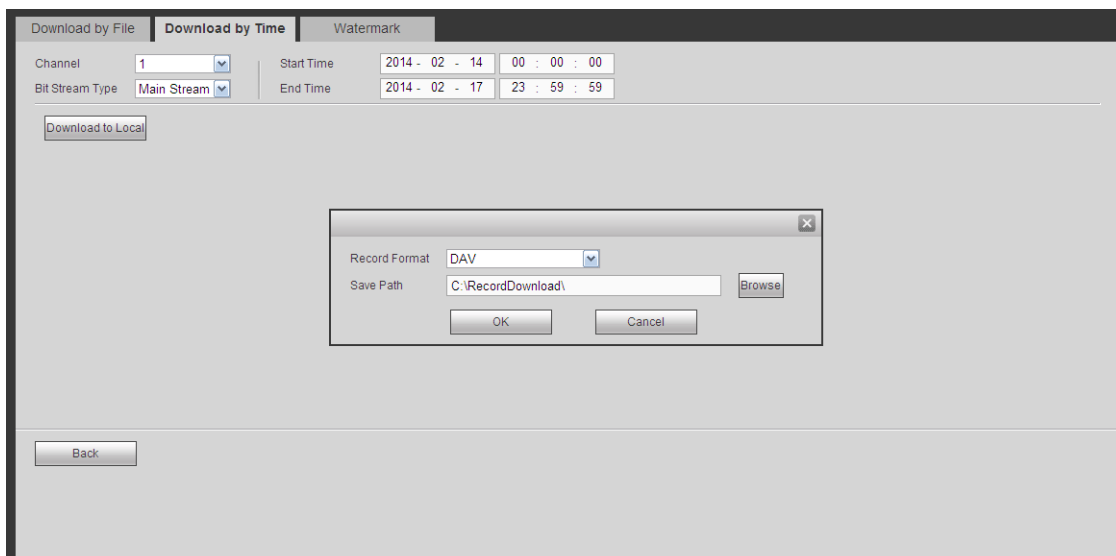

Figure 5-164

Set record format and saved path, you can click OK to download and view the download process. After the download operation, you can see corresponding dialog box.

5.6.7.3 Watermark

Watermark interface is shown as In Figure 5-165. Please select a file and then click Verify button to see the file has been tampered with or not

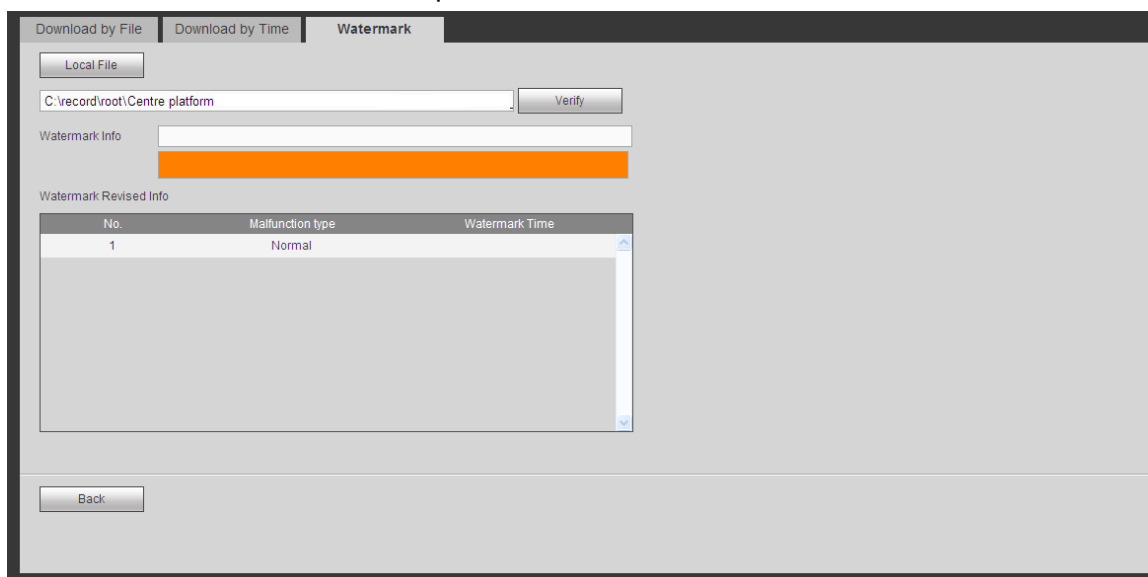
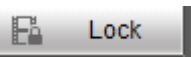

Figure 5-165

5.6.8 Lock or Unlock File

On the playback interface, click File list button, you can view file list (Figure 5-159.). Select a file first and then click lock button . You can lock it in case it is overwritten in the future.

Note

The file is writing or is overwriting can not be locked.

Click  you can view the locked file. See Figure 5-166.

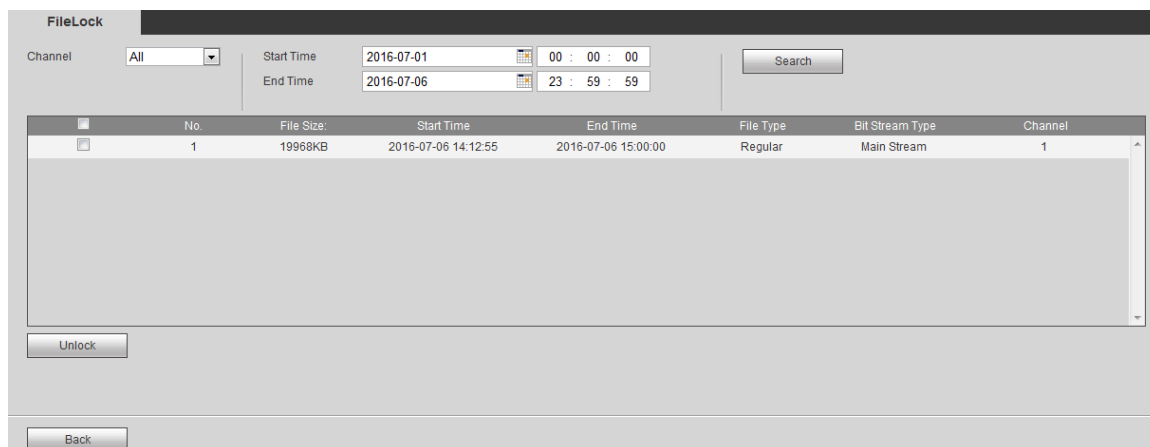

Figure 5-166

Select a file in the above figure and then click Unlock, you can unlock it. The locked file will not be overwritten after you enabled overwrite function.

5.7 Alarm

Click alarm function, you can see an interface is shown as Figure 5-167.

Here you can set device alarm type and alarm sound setup (Please make sure you have enabled audio function of corresponding alarm events.).

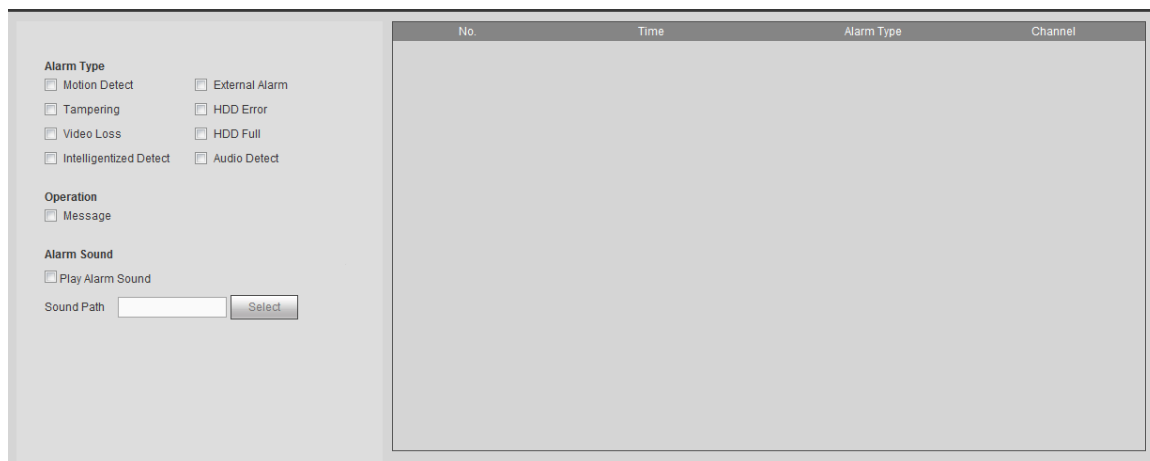

Figure 5-167

Please refer to the following sheet for detailed information.

Type	Parameter	Function
Alarm Type	Video loss	System alarms when video loss occurs.
	Motion detection	System alarms when motion detection alarm occurs.
	Tampering	System alarms when camera is viciously masking.

Type	Parameter	Function
	Disk full	System alarms when disk is full.
	Disk error	System alarms when disk error occurs.
	External alarm	Alarm input device sends out alarm.
	Intelligent alarm	The IVS rule you set in smart plan can trigger intelligent alarm.
Operation	Prompt	Check the box here, system can automatically pops up an alarm icon on the Alarm button in the main interface when there is an alarm.
Alarm Sound	Play alarm sound	System sends out alarm sound when an alarm occurs. You can specify as you wish.
	Sound path	Here you can specify alarm sound file.

5.8 Information

5.8.1 Version

From main menu->Info->Version, the version interface is shown as in Figure 5-168. Here you can view record channel, alarm input/output information, software version, release date and etc. Please note the following information is for reference only.

VERSION	
Type:	HCVR
Record Channel:	64
Alarm In:	16
Alarm Out:	6
Hardware Version:	V3.0
SN:	000000000000000000
Web:	3.2.7.68952
Onvif Server Version:	2.4.1
Onvif Client Version:	2.4.1
System Version:	3.216.0000.00, Build Date: 2016-07-03

Figure 5-168

5.8.2 Log

From main menu->Info->Log, here you can view system log. See Figure 5-169.

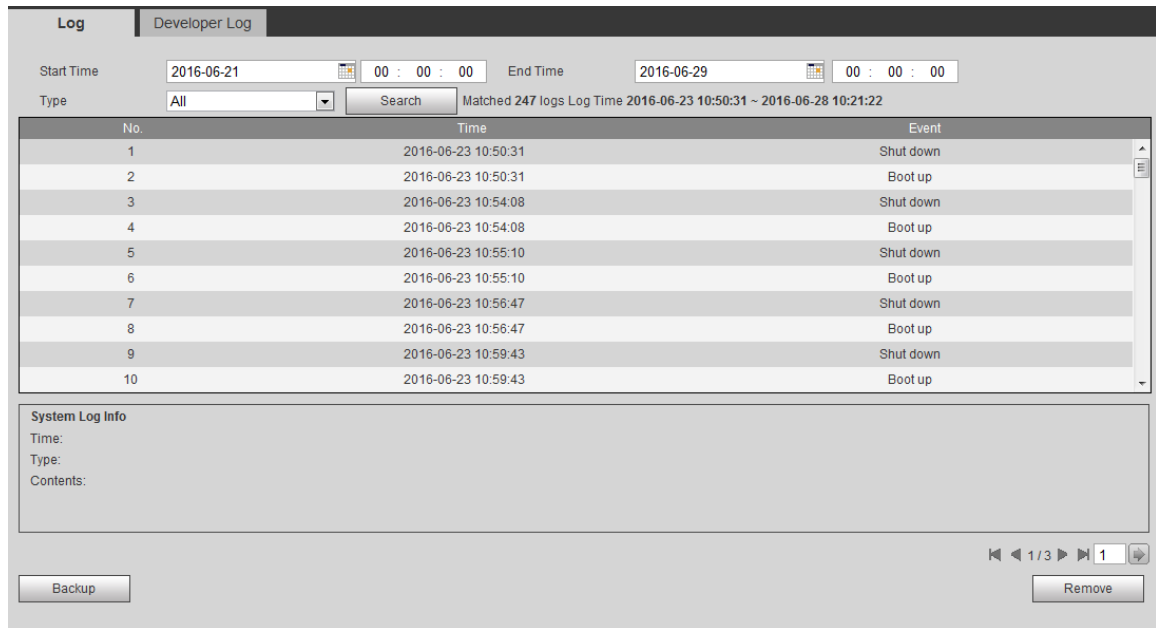

Figure 5-169

Please refer to the following sheet for log parameter information.

Parameter	Function
Type	Log types include: system operation, configuration operation, data operation, event operation, and record operation, and user management, log clear.
Start time	Set the start time of the requested log.
End time	Set the end time of the requested log.
Search	You can select log type from the drop down list and then click search button to view the list. You can click the stop button to terminate current search operation.
Detailed information	You can select one item to view the detailed information.
Clear	You can click this button to delete all displayed log files. Please note system does not support clear by type.
Backup	You can click this button to backup log files to current PC.

Note

- If there is no HDD, system max supports 10,000 logs.
- If you have connected to the formatted HDD, system max supports 500,000 logs.
- System operation logs are saved in system memory. Other types of logs are saved in the HDD. If there is no HDD, other types of logs are saved in the system memory too.
- The logs are safe when you format the HDD. But the logs may become loss once you removed the HDD from the DVR.

File Name	Size(KB)	Download
backtrace.out	1.81	
badDiskInfo	0.14	
exception	269.18	
HddInfo	14.82	
KmsgInfo	74.68	
VersionInfo	0.12	

5.8.3 Online User

From main menu->Info->Online user the online user interface is shown as in Figure 5-170. Click Refresh to get the latest online user information.

No.	User Name	Group Name	IP Address	User Login Time
1	admin	admin	10.18.116.76	2016-06-28 08:37:33

Refresh

Figure 5-170

5.8.4 HDD

From main menu->Info->HDD, the HDD interface is shown as in Figure 5-171. Here you can view HDD information.

No.	Device Name	Status	Free Space/Total Space	S.M.A.R.T
1	SATA-1	Normal	1.64TB/1.81TB	Normal

Refresh

Figure 5-171

View S.M.A.R.T Info

In Figure 5-171, double click S.M.A.R.T icon , you can go to the following interface.

Here you can view HDD name, model, serial number status and detailed information. See Figure 5-172.

S.M.A.R.T INFO

Name: sda
 Model: WDC WD10PURX-64E
 Serial No.: WD-WCC4J2PJU2U8
 Status: OK

Describe:

Smart ID	Attribute	Threshold	Value	Worst Value	Status
1	Read Error Rate	51	200	200	OK
3	Spin Up Time	21	150	126	OK
4	Start/Stop Count	0	99	99	OK
5	Reallocated Sector Count	140	200	200	OK
7	Seek Error Rate	0	200	200	OK
9	Power On Hours Count	0	99	99	OK
10	Spin-up Retry Count	0	100	100	OK
11	Calibrate Retry Count	0	100	100	OK

Figure 5-172

View HDD record time

In Figure 5-171, click HDD time button, you can go to the following interface. Here you can view record file start time and end time. See Figure 5-173.

HDD Time

Device Name	Start Time	End Time
sda	2016-06-14 20:29:21	2016-06-20 19:00:06
	2016-06-22 10:36:07	2016-06-23 00:34:00
	2016-06-23 13:50:28	2016-07-01 20:03:07
	2016-07-06 14:12:55	2016-07-06 14:13:40
	2016-06-11 23:38:34	2016-06-12 12:23:19
	2016-06-12 12:19:27	2016-06-13 09:05:29
	2016-06-13 09:01:33	2016-06-14 20:29:21
	2016-06-23 11:32:37	2016-06-23 13:49:16

Figure 5-173

5.8.5 Network Sniffer

It is to backup network sniffer files. The backup data can be used for the engineer from the R&D or the installer to analyze the network status.

From main menu->Info->Network Sniffer, you can go to the following interface. See Figure 5-174.

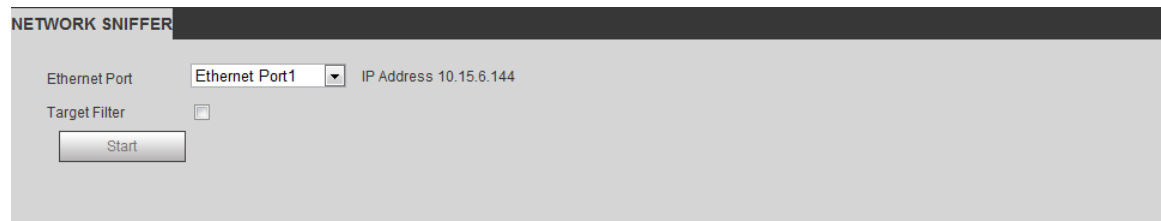

Figure 5-174

Please refer to the following sheet for detailed information.

Parameters	Function
Ethernet port	Please select a Ethernet port from the dropdown list.
Target filter	Check the box here and then input the corresponding IP address, DVR only sniffer the data from the specified IP address. If you do not check the box here, DVR sniffer data from all related IP addresses.

5.9 Log out

Click log out button, system goes back to log in interface. See Figure 5-175.

You need to input user name and password to login again.

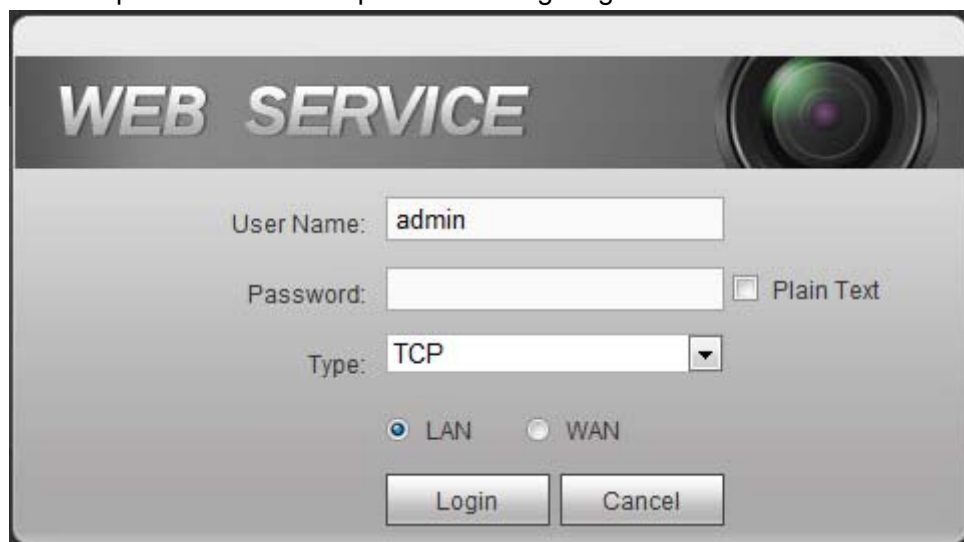

Figure 5-175

5.10 Un-install Web Control

You can use web un-install tool “uninstall web.bat” to un-install web control.

Please note, before you un-installation, please close all web pages, otherwise the un-installation might result in error.

6 SmartPSS

Besides Web, you can use our Smart PSS to login the device.

For detailed information, please refer to *Smart PSS user's manual*.

7 FAQ

1. DVR can not boot up properly.

There are following possibilities:

- Input power is not correct.
- Power connection is not correct.
- Power switch button is damaged.
- Program upgrade is wrong.
- HDD malfunction or something wrong with HDD ribbon.
- Seagate DB35.1, DB35.2, SV35 or Maxtor 17-g has compatibility problem.
Please upgrade to the latest version to solve this problem.
- Front panel error.
- Main board is damaged.

2. DVR often automatically shuts down or stops running.

There are following possibilities:

- Input voltage is not stable or it is too low.
- HDD malfunction or something wrong with the ribbon.
- Button power is not enough.
- Front video signal is not stable.
- Working environment is too harsh, too much dust.
- Hardware malfunction.

3. System can not detect hard disk.

There are following possibilities:

- HDD is broken.
- HDD ribbon is damaged.
- HDD cable connection is loose.
- Main board SATA port is broken.

4. There is no video output whether it is one-channel, multiple-channel or all-channel output.

There are following possibilities:

- Program is not compatible. Please upgrade to the latest version.
- Brightness is 0. Please restore factory default setup.
- There is no video input signal or it is too weak.
- Check privacy mask setup or your screen saver.
- DVR hardware malfunctions.

5. Real-time video color is distorted.

There are following possibilities:

- When using BNC output, NTSC and PAL setup is not correct. The real-time video becomes black and white.

- DVR and monitor resistance is not compatible.
- Video transmission is too long or degrading is too huge.
- DVR color or brightness setup is not correct.

6. Can not search local records.

There are following possibilities:

- HDD ribbon is damaged.
- HDD is broken.
- Upgraded program is not compatible.
- The recorded file has been overwritten.
- Record function has been disabled.

7. Video is distorted when searching local records.

There are following possibilities:

- Video quality setup is too low.
- Program read error, bit data is too small. There is mosaic in the full screen. Please restart the DVR to solve this problem.
- HDD data ribbon error.
- HDD malfunction.
- DVR hardware malfunctions.

8. There is no audio when monitor.

There are following possibilities:

- It is not a power picker.
- It is not a power acoustics.
- Audio cable is damaged.
- DVR hardware malfunctions.

9. There is audio when monitor but there is no audio when system playback.

There are following possibilities:

- Setup is not correct. Please enable audio function
- Corresponding channel has no video input. Playback is not continuous when the screen is blue.

10. Time display is not correct.

There are following possibilities:

- Setup is not correct
- Battery contact is not correct or voltage is too low.
- Crystal is broken.

11. DVR can not control PTZ.

There are following possibilities:

- Front panel PTZ error

- PTZ decoder setup, connection or installation is not correct.
- Cable connection is not correct.
- PTZ setup is not correct.
- PTZ decoder and DVR protocol is not compatible.
- PTZ decoder and DVR address is not compatible.
- When there are several decoders, please add 120 Ohm between the PTZ decoder A/B cables furthest end to delete the reverberation or impedance matching. Otherwise the PTZ control is not stable.
- The distance is too far.

12. Motion detection function does not work.

There are following possibilities:

- Period setup is not correct.
- Motion detection zone setup is not correct.
- Sensitivity is too low.
- For some versions, there is hardware limit.

13. Can not log in client-end or web.

There are following possibilities:

- For Windows 98 or Windows ME user, please update your system to Windows 2000 sp4. Or you can install client-end software of lower version. Please note right now, our DVR is not compatible with Windows VISTA control.
- ActiveX control has been disabled.
- No dx8.1 or higher. Please upgrade display card driver.
- Network connection error.
- Network setup error.
- Password or user name is invalid.
- Client-end is not compatible with DVR program.

14. There is only mosaic no video when preview or playback video file remotely.

There are following possibilities:

- Network fluency is not good.
- Client-end resources are limit.
- There is multiple-cast group setup in DVR. This mode can result in mosaic. Usually we do not recommend this mode.
- There is privacy mask or channel protection setup.
- Current user has no right to monitor.
- DVR local video output quality is not good.

15. Network connection is not stable.

There are following possibilities:

- Network is not stable.
- IP address conflict.

- MAC address conflict.
- PC or DVR network card is not good.

16. Burn error /USB back error.

There are following possibilities:

- Burner and DVR are in the same data cable.
- System uses too much CPU resources. Please stop record first and then begin backup.
- Data amount exceeds backup device capacity. It may result in burner error.
- Backup device is not compatible.
- Backup device is damaged.

17. Keyboard can not control DVR.

There are following possibilities:

- DVR serial port setup is not correct
- Address is not correct
- When there are several switchers, power supply is not enough.
- Transmission distance is too far.

18. Alarm signal can not be disarmed.

There are following possibilities:

- Alarm setup is not correct.
- Alarm output has been open manually.
- Input device error or connection is not correct.
- Some program versions may have this problem. Please upgrade your system.

19. Alarm function is null.

There are following possibilities:

- Alarm setup is not correct.
- Alarm cable connection is not correct.
- Alarm input signal is not correct.
- There are two loops connect to one alarm device.

20. Remote control does not work.

There are following possibilities:

- Remote control address is not correct.
- Distance is too far or control angle is too small.
- Remote control battery power is low.
- Remote control is damaged or DVR front panel is damaged.

21. Record storage period is not enough.

There are following possibilities:

- Camera quality is too low. Lens is dirty. Camera is installed against the light. Camera aperture setup is not correct.
- HDD capacity is not enough.
- HDD is damaged.

22. Can not playback the downloaded file.

There are following possibilities:

- There is no media player.
- No DXB8.1 or higher graphic acceleration software.
- There is no DivX503Bundle.exe control when you play the file transformed to AVI via media player.
- No DivX503Bundle.exe or ffdshow-2004 1012 .exe in Windows XP OS.

23. Forgot local menu operation password or network password

Please contact your local service engineer or our sales person for help. We can guide you to solve this problem.

24. When I login via HTTPS, a dialogue says the certificate for this website is for other address.

Please follow chapter 5.5.2.2.3 to create server certificate.

25. When I login via HTTPS, a dialogue says the certificate is not trusted.

Please follow chapter 5.5.2.2.4 to download root certificate.

26. When I login via HTTPS, a dialogue says the certificate has expired or is not valid yet.

Please make sure your PC time is the same as the device time.

27. I connect the general analog camera to the device, there is no video output.

There are following possibilities:

- Check camera power supplying, data cable connection and etc.
- This series device does not support the analog camera of all brands. Please make sure the device supports general standard definition analog camera.

28. I connect the standard definition analog camera or the HD AVS camera to the device, there is no video output.

There are following possibilities:

- Check camera power supplying, or camera data cable connection.
- For the product supports analog standard definition camera/HD camera, you need to go to the main menu->Setting->Camera->Channel type to select corresponding channel type and then restart the DVR.

29. I can not connect to the IP channel.

There are following possibilities:

- Check the camera is online or not.
- Check IP channel setup is right or not (such as IP address, user name, password, connection protocol, port number.).
- The camera has set the whitelist (Only the specified devices can connect to the camera).

30. After I connected to the IP channel, there one-window output is OK, but there is no multiple-window output.

There are following possibilities:

- Check the sub stream of the camera has been enabled or not.
- Check the sub stream type of the camera is H.264 or not.
- Check the device supports camera sub stream resolution or not (such as 960H, D1, HD1 and etc.).

31. After I connected to the IP channel, there multiple-window output is OK, but there is no one-window output.

There are following possibilities:

- Check there is video from the IP channel or not. Please go to the main menu->info->System->BPS to view bit stream real-time information.
- Check the main stream of the camera has been enabled or not.
- Check the main stream type of the camera is H.264 or not.
- Check the device supports camera main stream resolution or not (such as 960H, D1, HD1 and etc.).
- Check camera network transmission has reached the threshold or not. Please check the online user of the camera.

32. After I connected to the IP channel, there is no video output in the one-window or the multiple-window mode. But I can see there is bit stream.

There are following possibilities:

- Check the main stream/sub stream type of the camera is H.264 or not.
- Check the device supports camera main stream/sub stream resolution or not (such as 1080P, 720P, 960H, D1, HD1 and etc.).
- Check the camera setup. Please make sure It supports the products of other manufacturers.

33. DDNS registration failed or can not access the device domain name.

There are following possibilities:

- Check the device is connected to the WAN. Please check the device has got the IP address if the PPPoE can dial. If there is a router, please check the router to make sure the device IP is online.
- Check the corresponding protocol of the DDNS is enabled. Check the DDNS function is OK or not.

- Check DNS setup is right or not. Default Google DNS server is 8.8.8.8, 8.8.5.5. You can use different DNS provided by your ISP.

34. I can not use the P2P function on my cell phone or the WEB.

There are following possibilities:

- Check the device P2P function is enabled or not. (Main menu->Setting->Network->P2P)
- Check the device is in the WAN or not.
- Check cell phone P2P login mode is right or not.
- It is the specified device P2P login port or not when you are using P2P client.
- Check user name or password is right or not.
- Check P2P SN is right or not. You can use the cell phone to scan the QR code on the device P2P interface (Main menu->Setting->Network->P2P), or you can use the version information of the WEB to confirm. (For some previous series products, the device SN is the main board SN, it may result in error.)

35. I connect the standard definition camera to the device, there is no video output.

There are following possibilities:

- Check the DVR supports standard definition signal or not. Only some series product supports analog standard definition signal, HD AVS signal input.
- Check channel type is right or not. For the product supports analog standard definition camera/HD camera, you need to go to the main menu->Setting->Camera->Channel type to select corresponding channel type (such as analog) and then restart the DVR. In this way, the DVR can recognize the analog standard definition.
- Check camera power supplying, or camera data cable connection.

36. I can not connect to the IP camera.

There are following possibilities:

- Check DVR supports IP channel or not. Only some series products support A/D switch function, it can switch analog channel to the IP channel to connect to the IP camera. From Setting->Camera->Channel Type, select the last channel to switch to the IP channel. Some series product products support IP channel extension, it supports N+N mode.
- Check the IPC and the DVR is connected or not. Please go to the main menu->Setting->Camera->Remote to search to view the IP camera is online or not. Or you can go to the main menu->Info->Network->Test, you can input IP camera IP address and then click the Test button to check you can connect to the IP camera or not.
- Check IP channel setup is right or not (such as IP address, manufacturer, port, user name, password, remote channel number and etc.).

Daily Maintenance

- Please use the brush to clean the board, socket connector and the chassis regularly.
- The device shall be soundly earthed in case there is audio/video disturbance. Keep the device away from the static voltage or induced voltage.
- Please unplug the power cable before you remove the audio/video signal cable, RS232 or RS485 cable.
- Do not connect the TV to the local video output port (VOUT).It may result in video output circuit.
- Always shut down the device properly. Please use the shutdown function in the menu, or you can press the power button in the front panel for at least three seconds to shut down the device. Otherwise it may result in HDD malfunction.
- Please make sure the device is away from the direct sunlight or other heating sources. Please keep the sound ventilation.
- Please check and maintain the device regularly.

Appendix A HDD Capacity Calculation

Calculate total capacity needed by each DVR according to video recording (video recording type and video file storage time).

Step 1: According to Formula (1) to calculate storage capacity q_i that is the capacity of each channel needed for each hour, unit Mbyte.

$$q_i = d_i \div 8 \times 3600 \div 1024 \quad (1)$$

In the formula: d_i means the bit rate, unit Kbit/s

Step 2: After video time requirement is confirmed, according to Formula (2) to calculate the storage capacity m_i , which is storage of each channel needed unit Mbyte.

$$m_i = q_i \times h_i \times D_i \quad (2)$$

In the formula:

h_i means the recording time for each day (hour)

D_i means number of days for which the video shall be

kept

Step 3: According to Formula (3) to calculate total capacity (accumulation) q_T that is needed for all channels in the DVR during **scheduled video recording**.

$$q_T = \sum_{i=1}^c m_i \quad (3)$$

In the formula: c means total number of channels in one DVR

Step 4: According to Formula (4) to calculate total capacity (accumulation) q_T that is needed for all channels in DVR during **alarm video recording (including motion detection)**.

$$q_T = \sum_{i=1}^c m_i \times a\% \quad (4)$$

In the formula: $a\%$ means alarm occurrence rate

You can refer to the following sheet for the file size in one hour per channel. (All the data listed below are for reference only.)

Bit stream size (max)	File size	Bit stream size (max)	File size
96K	42M	128K	56M
160K	70M	192K	84M
224K	98M	256K	112M
320K	140M	384K	168M

448K	196M	512K	225M
640K	281M	768K	337M
896K	393M	1024K	450M
1280K	562M	1536K	675M
1792K	787M	2048K	900M

Appendix B Compatible backup devices

Appendix B-1 Compatible USB list

Manu factor	Model	Capacity
Sandisk	Cruzer Micro	512M
Sandisk	Cruzer Micro	1G
Sandisk	Cruzer Micro	2G
Sandisk	Cruzer Freedom	256M
Sandisk	Cruzer Freedom	512M
Sandisk	Cruzer Freedom	1G
Sandisk	Cruzer Freedom	2G
Kingston	DataTraveler II	1G
Kingston	DataTraveler II	2G
Kingston	DataTraveler	1G
Kingston	DataTraveler	2G
Maxell	USB Flash Stick	128M
Maxell	USB Flash Stick	256M
Maxell	USB Flash Stick	512M
Maxell	USB Flash Stick	1G
Maxell	USB Flash Stick	2G
Kingax	Super Stick	128M
Kingax	Super Stick	256M
Kingax	Super Stick	512M
Kingax	Super Stick	1G
Kingax	Super Stick	2G
Netac	U210	128M
Netac	U210	256M
Netac	U210	512M
Netac	U210	1G
Netac	U210	2G
Netac	U208	4G
Teclast	Ti Cool	128M
Teclast	Ti Cool	256M
Teclast	Ti Cool	512M
Teclast	Ti Cool	1G
SanDisk	cruzer mirco	2G
SanDisk	cruzer mirco	8G
SanDisk	Ti Cool	2G
SanDisk	Hongjiao	4G
Lexar	Lexar	256MB
Kingston	Data Traveler	1G
Kingston	Data Traveler	16GB

Kingston	Data Traveler	32GB
Aigo	L8315	16GB
Sandisk	250	16GB
Kingston	Data Traveler Locker+	32GB
Netac	U228	8GB

Appendix B-2 Compatible SD Card list

Brand	Standard	Capacity	Card type
Transcend	SDHC6	16GB	Big
Kingston	SDHC4	4GB	Big
Kingston	SD	2GB	Big
Kingston	SD	1GB	Big
Sandisk	SDHC2	8GB	Small
Sandisk	SD	1GB	Small

Appendix B-3 Compatible Portable HDD list

Brand	Model	Capacity
YDStar	YDstar HDD box	40G
Netac	Netac	80G
lomega	lomega RPHD-CG" RNAJ50U287	250GB
WD Elements	WCAVY1205901	1.5TB
Newsmy	Liangjian	320GB
WD Elements	WDBAAR5000ABK-00	500GB
WD Elements	WDBAAU0015HBK-00	1.5TB
Seagate	FreeAgent Go(ST905003F)	500GB
Aigo	H8169	500GB

Appendix B-4 Compatible USB DVD List

Brand	Model
Samsung	SE-S084
BenQ	LD2000-2K4

Appendix B-5 Compatible SATA DVD List

Brand	Model
LG	GH22NS30
Samsung	TS-H653 Ver.A

Samsung	TS-H653 Ver.F
Samsung	SH-224BB/CHXH
SONY	DRU-V200S
SONY	DRU-845S
SONY	AW-G170S
Pioneer	DVR-217CH

Appendix B-6 Compatible SATA HDD List

NOTE: Please upgrade the DVR firmware to latest version to ensure the accuracy of the table below. Here we recommend HDD of 500G to 4T capacity.

Manufacturer	Series	Model	Capacity	Port Mode
Seagate	Seagate SV35.1	ST3250824SV	250G	SATA
Seagate	Seagate SV35.1	ST3500641SV	500G	SATA
Seagate	Seagate SV35.2	ST3250820SV	250G	SATA
Seagate	Seagate SV35.2	ST3320620SV	320G	SATA
Seagate	Seagate SV35.2	ST3500630SV	500G	SATA
Seagate	Seagate SV35.2	ST3750640SV	750G	SATA
Seagate	Seagate SV35.3	ST3250310SV	250G	SATA
Seagate	Seagate SV35.3	ST3500320SV	500G	SATA
Seagate	Seagate SV35.3	ST3750330SV	750G	SATA
Seagate	Seagate SV35.3	ST31000340SV	1T	SATA
Seagate	Seagate SV35.4	ST3320410SV	320G	SATA
Seagate	Seagate SV35.4	ST3250311SV	250G	SATA
Seagate	Seagate SV35.5	ST3500410SV	500G	SATA
Seagate	Seagate SV35.5	ST3500411SV	500G	SATA
Seagate	Seagate SV35.5	ST31000525SV	1T	SATA
Seagate	Seagate SV35.5	ST31000526SV	1T	SATA
Seagate	Seagate SV35.5	ST1000VX000	1T	SATA
Seagate	Seagate SV35.5	ST2000VX003	2T	SATA
Seagate	Seagate SV35.5	ST2000VX002	2T	SATA
Seagate	Seagate SV35.5	ST2000VX000	2T	SATA
Seagate	Seagate SV35.5	ST3000VX000	3T	SATA
Seagate	Seagate Pipeline HD	ST3320410CS	320G	SATA
Seagate	Seagate Pipeline HD	ST3320310CS	320G	SATA
Seagate	Seagate Pipeline HD	ST3500422CS	500G	SATA
Seagate	Seagate Pipeline HD	ST3500321CS	500G	SATA
Seagate	Seagate Pipeline HD2	ST3250412CS	250G	SATA
Seagate	Seagate Pipeline HD2	ST3320311CS	250G	SATA
Seagate	Seagate Pipeline HD2	ST3500414CS	500G	SATA
Seagate	Seagate Pipeline HD2	ST3500312CS	500G	SATA
Seagate	Seagate Pipeline HD2	ST31000424CS	1T	SATA

Seagate	Seagate Pipeline HD2	ST31000322CS	1T	SATA
Seagate	Seagate Pipeline HD2	ST1000VM002	1T	SATA
Seagate	Seagate Pipeline HD2	ST1500VM002	1T	SATA
Seagate	Seagate Pipeline HD2	ST2000VM002	2T	SATA
Seagate	Seagate Pipeline HD2	ST2000VM003	2T	SATA
Seagate	Seagate Constellation ES	ST3500514NS	500G	SATA
Seagate	Seagate Constellation ES	ST31000524NS	1T	SATA
Seagate	Seagate Constellation ES	ST32000644NS	2T	SATA
Seagate	Seagate Constellation ES	ST2000NM0011	2T	SATA
Seagate	Seagate Constellation ES	ST1000NM0011	1T	SATA
Seagate	Seagate Constellation ES	ST500NM0011	500G	SATA
Seagate	Seagate Constellation ES	ST2000NM0031	2T	SATA
Seagate	Seagate Constellation ES	ST1000NM0031	1T	SATA
Seagate	Seagate Constellation ES	ST500NM0031	500G	SATA
Seagate	Seagate Constellation ES	ST2000NM0051	2T	SATA
Seagate	Seagate Constellation ES	ST1000NM0051	1T	SATA
Seagate	Seagate Constellation ES	ST500NM0051	500G	SATA
Seagate	Seagate Constellation ES.2	ST33000650NS	3T	SATA
Seagate	Seagate Constellation ES.2	ST32000645NS	2T	SATA
Seagate	Seagate Constellation ES.2	ST33000651NS	3T	SATA
Seagate	Seagate Constellation ES.2	ST32000646NS	2T	SATA
Seagate	Seagate Constellation ES.2	ST33000652NS	3T	SATA
Seagate	Seagate Constellation ES.2	ST32000647NS	2T	SATA
Western Digital	Cariar SE	WD3200JD	320G	SATA
Western Digital	Cariar SE	WD3000JD	300G	SATA

Western Digital	Caviar SE	WD2500JS	250G	SATA
Western Digital	Caviar SE16	WD7500KS	750G	SATA
Western Digital	Caviar SE16	WD5000KS	500G	SATA
Western Digital	Caviar SE16	WD4000KD	400G	SATA
Western Digital	Caviar SE16	WD3200KS	320G	SATA
Western Digital	Caviar SE16	WD2500KS	250G	SATA
Western Digital	WD Caviar SE16	WD2500YS-01SHB0	250G	SATA
Western Digital	WD Caviar RE16	WD3200YS-01PGB0	320G	SATA
Western Digital	WD Caviar RE2	WD5000YS-01MPB0	500G	SATA
Western Digital	WD AV—AVJS	WD2500AVJS-63WDA0	500G	SATA
Western Digital	WD AV—AVJS	WD3200AVJS-63WDA0	320G	SATA
Western Digital	WD AV—AVJS	WD5000AVJS-63YJA0	500G	SATA
Western Digital	WDAV-GP—AVCS	WD5000AVCS-63H1B1	500G	SATA
Western Digital	WDAV-GP—AVCS	WD7500AVCS-63ZLB0	750G	SATA
Western Digital	WDAV-GP—AVCS	WD3200AVCS	320G	SATA
Western Digital	WDAV-GP—AVCS	WD2500AVCS	250G	SATA
Western Digital	WDAV-GP—EVCS	WD10EVCS-63ZLB0	1T	SATA
Western Digital	WDAV-GP—EVCS	WD20EVCS-63ZLB0	2T	SATA
Western Digital	WDAV-GP—AVVS	WD3200AVVS-63L2B0	320G	SATA
Western Digital	WDAV-GP—AVVS	WD5000AVVS-63ZWB0	500G	SATA
Western Digital	WDAV-GP—AVVS	WD7500AVVS-63E1B1	750G	SATA
Western Digital	WDAV-GP—AVVS	WD7500AVVS-63E1B1	750G	SATA
Western Digital	WDAV-GP—EVVS	WD10EVVS-63E1B1	1T	SATA
Western Digital	WDAV-GP—EVDS	WD10EVDS-63N5B1	1T	SATA
Western Digital	WDAV-GP—EVDS	WD15EVDS-63V9B0	1.5T	SATA
Western Digital	WDAV-GP—EVDS	WD20EVDS-63T3B0	2T	SATA
Western Digital	WDAV-GP—AVDS	WD5000AVDS-63U7B0	500G	SATA
Western Digital	WD AV-GP	WD30EURS	3T	SATA
Western Digital	WD AV-GP	WD25EURS	2.5T	SATA
Western Digital	WD AV-GP	WD20EURS	2T	SATA
Western Digital	WD AV-GP	WD15EURS	1.5T	SATA
Western Digital	WD AV-GP	WD10EURS	1T	SATA
Western Digital	WD AV-GP	WD10EURX	1T	SATA
Western Digital	WD AV-GP	WD7500AURS	750G	SATA
Western Digital	WD AV-GP	WD7500AVDS	500G	SATA
Western Digital	WD AV-GP	WD500AVDS	500G	SATA
Western Digital	WD AV-GP	WD10EUCX	1T	SATA
Samsung	Samsung—HA	HA500LJ/CE	500G	SATA
Samsung	Samsung—HA	HA751LJ	750G	SATA
Samsung	Samsung—HA	HA101UJ/CE	1T	SATA
Samsung	Samsung—HD	HD502HI/CEC	500G	SATA
Samsung	Samsung—HD	HD103SI/CEC	1T	SATA
Samsung	Samsung—HD	HD154UI/CE	1.5T	SATA

Hitachi	HitachiCinemaStar™ 5K500	HCP725050GLA380	500G	SATA
Hitachi	HitachiCinemaStar™ 7K1000.B	HCT721050SLA360	500G	SATA
Hitachi	HitachiCinemaStar™ 7K1000.B	HCT721075SLA360	750G	SATA
Hitachi	HitachiCinemaStar™ 7K1000.B	HCT721010SLA360	1T	SATA
Maxtor	DiamondMax 20	STM3320820AS	320G	SATA
Maxtor	DiamondMax 20	STM3250820AS	250G	SATA

Appendix C Compatible CD/DVD Burner List

NOTE: Please upgrade the DVR firmware to latest version to ensure the accuracy of the table below. And you can use the USB cable with the model recommended to set USB burner.

Manufacturer	Model	Port Type	Type
Sony	DRX-S50U	USB	DVD-RW
Sony	DRX-S70U	USB	DVD-RW
Sony	AW-G170S	SATA	DVD-RW
Samsung	TS-H653A	SATA	DVD-RW
Panasonic	SW-9588-C	SATA	DVD-RW
Sony	DRX-S50U	USB	DVD-RW
BenQ	5232WI	USB	DVD-RW

Appendix D Compatible Displayer List

Please refer to the following sheet form compatible displayer list.

Brand	Model	Dimension (Unit: inch)
BENQ (LCD)	ET-0007-TA	19-inch (wide screen)
DELL (LCD)	E178FPc	17-inch
BENQ (LCD)	Q7T4	17-inch
BENQ (LCD)	Q7T3	17-inch
HFNOVO (LCD)	LXB-L17C	17-inch
SANGSUNG (LCD)	225BW	22 寸(wide screen)
HFNOVO(CRT)	LXB-FD17069HB	17 -inch
HFNOVO(CRT)	LXB-HF769A	17-inch
HFNOVO(CRT)	LX-GJ556D	17-inch
Samsung (LCD)	2494HS	24-inch
Samsung (LCD)	P2350	23-inch
Samsung (LCD)	P2250	22-inch
Samsung (LCD)	P2370G	23-inch
Samsung (LCD)	2043	20-inch
Samsung (LCD)	2243EW	22-inch
Samsung (LCD)	SMT-1922P	19-inch
Samsung (LCD)	T190	19-inch
Samsung (LCD)	T240	24-inch
LG (LCD)	W1942SP	19-inch
LG (LCD)	W2243S	22-inch
LG (LCD)	W2343T	23-inch
BENQ (LCD)	G900HD	18.5-inch
BENQ(LCD)	G2220HD	22-inch
PHILIPS (LCD)	230E	23-inch
PHILIPS (LCD)	220CW9	23-inch
PHILIPS (LCD)	220BW9	24-inch
PHILIPS (LCD)	220EW9	25-inch

Appendix E Compatible Switcher

Brand	Model	network working mode
D-LinK	DES-1016D	10/100M self-adaptive
D-LinK	DES-1008D	10/100M self-adaptive
Ruijie	RG-S1926S	Five network modes 1. AUTO 2. HALF-10M 3. FULL-10M 4. HALF-100M 5. FULL-100M
H3C	H3C-S1024	10/100M self-adaptive
TP-LINK	TL-SF1016	10/100M self-adaptive
TP-LINK	TL-SF1008+	10/100M self-adaptive

Appendix F Compatible Wireless Mouse List

Please refer to the following sheet for compatible SD card brand.

Brand	Model
SUNT 讯拓™	V80
Rapoo	3500
Logitech	M215
Shuangfeiyan	Tianyao G7-630

Appendix G Earthing

1. What is the surge?

Surge is a short current or voltage change during a very short time. In the circuit, it lasts for microsecond. In a 220V circuit, the 5KV or 10KV voltage change during a very short time (about microseconds) can be called a surge. The surge comes from two ways: external surge and internal surge.

- The external surge: The external surge mainly comes from the thunder lightning. Or it comes from the voltage change during the on/off operation in the electric power cable.
- The internal surge: The research finds 88% of the surge from the low voltage comes from the internal of the building such as the air conditioning, elevator, electric welding, air compressor, water pump, power button, duplicating machine and other device of inductive load.

The lightning surge is far above the load level the PC or the micro devices can support. In most cases, the surge can result in electric device chip damage, PC error code, accelerating the part aging, data loss and etc. Even when a small 20 horsepower inductive engine boots up or stops, the surge can reach 3000V to 50000V, which can adversely affect the electronic devices that use the same distribution box.

To protect the device, you need to evaluate its environment, the lightning affection degree objectively. Because surge has close relationship with the voltage amplitude, frequency, network structure, device voltage-resistance, protection level, ground and etc. The thunder proof work shall be a systematic project, emphasizing the all-round protection (including building, transmission cable, device, ground and etc.). There shall be comprehensive management and the measures shall be scientific, reliable, practical and economic. Considering the high voltage during the inductive thundering, the International Electrotechnical Committee (IEC) standard on the energy absorbing step by step theory and magnitude classification in the protection zone, you need to prepare multiple precaution levels.

You can use the lightning rod, lightning strap or the lightning net to reduce the damage to the building, personal injury or the property,

- The lightning protection device can be divided into three types:
Power lightning arrester: There are 220V single-phrase lightning arrester and 380V three-phrase lightening arrester (mainly in parallel connection, sometimes use series connection) You can parallel connect the power lightning arrester in the electric cable to reduce the short-time voltage change and release the surge current. From the BUS to the device, there are usually three levels so that system can reduce the voltage and release the current step by step to remove the thunderstorm energy and guarantee the device safety. You can select the replaceable module type, the terminal connection type and portable socket according to your requirement.

- Signal lightning arrester: This device is mainly used in the PC network, communication system. The connection type is serial connection. Once you connected the signal lightning arrester with the signal port, it can cut the channel of the thunderstorm to the device, and on the other hand, it can discharge the current to the ground to guarantee the device proper work. The signal lightning arrester has many specifications, and widely used in many devices such as telephone, network, analog communication, digital communication, cable TV and satellite antenna. For all the input port, especially those from the outdoor, you need to install the signal lightning arrester.
- Antenna feed cable lightning arrester: It is suitable for antenna system of the transmitter or the device system to receive the wireless signal. It uses the serial connection too.

Please note, when you select the lightning arrester, please pay attention to the port type and the earthing reliability. In some important environment, you need to use special shielded cable. Do not parallel connect the thunder proof ground cable with the ground cable of the lightning rod. Please make sure they are far enough and grounded respectively.

2. The earthing modes

We all know the earthing is the most complicated technology in the electromagnetism compatibility design since there is no systematic theory or module. The earthing has many modes, but the selection depends on the system structure and performance. The following are some successfully experience from our past work.

One-point ground: In the following figure you can see there is a one-point ground. This connection provides common port to allow signal to be transmitted in many circuits. If there is no common port, the error signal transmission occurred. In the one-point ground mode, each circuit is just grounded only and they are connected at the same port. Since there is only one common port, there is no circuit and so, there is no interference.

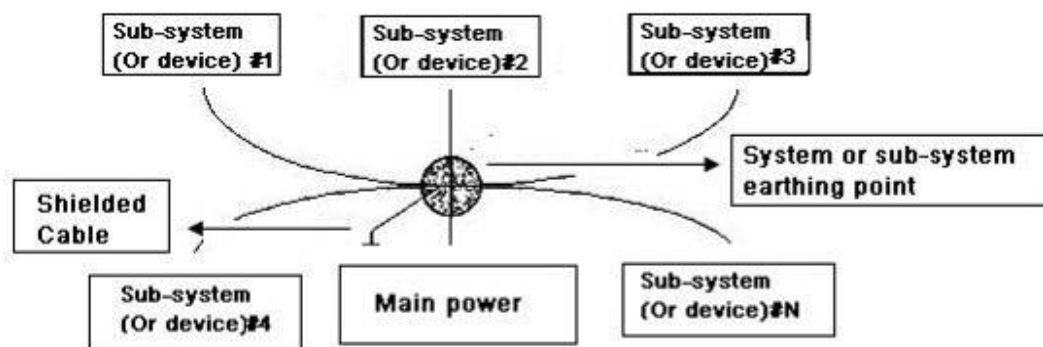

Multiple-point ground: In the following figure, you can see the internal circuit uses the chassis as the common point. While at the same time, all devices chassis use the earthing as the common port. In this connection, the ground structure can provide the lower ground resistance because when there are multiple-point grounds; each ground cable is as short as possible. And the parallel cable connection can reduce the total

conductance of the ground conductor. In the high-frequency circuit, you need to use the multiple-point ground mode and each cable needs to connect to the ground. The length shall be less than the 1/20 of the signal wavelength.

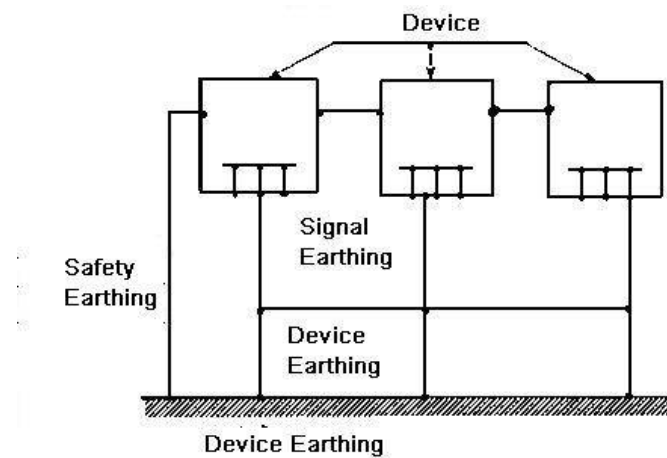

Mixed ground: The mixed ground consists of the feature of the one-point ground and multiple-point ground. For example, the power in the system needs to use the one-point ground mode while the radio frequency signal requires the multiple-point ground. So, you can use the following figure to earth. For the direct current (DC), the capacitance is open circuit and the circuit is one-point ground. For the radio frequency signal, the capacitance is conductive and the circuit adopts multiple-point ground.

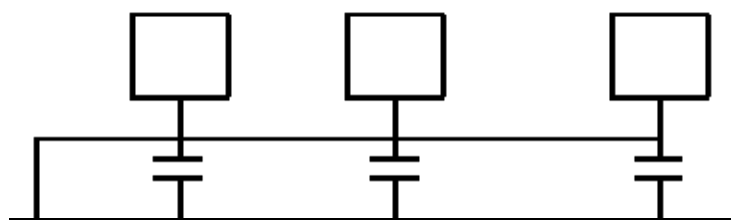

When connecting devices of huge size (the device physical dimension and connection cable is big comparing with the wave path of existed interference), then there are possibility of interference when the current goes through the chassis and cable. In this situation, the interference circuit path usually lies in the system ground circuit.

When considering the earthing, you need to think about two aspects: The first is the system compatibility, and the other is the external interference coupling into the earth circuit, which results in system error. For the external interference is not regular, it is not easy to resolve.

3. Thunder proof ground method in the monitor system

- The monitor system shall have sound thunder proof earthing to guarantee personnel safety and device safety.
- The monitor system working ground resistance shall be less than 1Ω.

- The thunder proof ground shall adopt the special ground cable from the monitor control room to the ground object. The ground cable adopts copper insulation cable or wire and its ground section shall be more than 20mm².
- The ground cable of the monitor system can not short circuit or mixed connected with the strong alternative current cable.
- For all the ground cables from the control room to the monitor system or ground cable of other monitor devices, please use the copper resistance soft cable and its section shall be more than 4mm².
- The monitor system usually can adopt the one-point ground.
- Please connect the ground end of 3-pin socket in the monitor system to the ground port of the system (protection ground cable)

4. The shortcut way to check the electric system using the digital multimeter

For 220V AC socket, from the top to the bottom, E (ground cable), N (neutral cable), L(live cable). Please refer to the following figure.

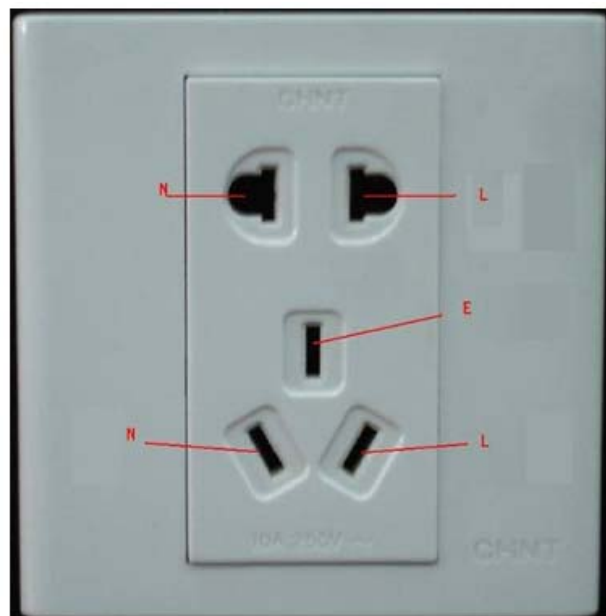

There is a shortcut way to check these three cables connection are standard or not (not the accurate check).

Importance

In the following operations, the multimeter range shall be at 750V!

For E (earth cable)

Turn the digital multimeter to 750V AC, use your one hand to hold the metal end, and then the other hand insert the pen to the E port of the socket. See the following figure. If the multimeter shows 0, then you can see current earth cable connection is standard. If the value is more than 10, then you can see there is inductive current and the earth cable connection is not proper.



For L (live cable)

Turn the digital multimeter to 750V AC, use your one hand to hold the metal end, and then the other hand insert the pen to the L port of the socket. See the following figure. If the multimeter shows 120, then you can see current live cable connection is standard. If the value is less than 60, then you can see current live cable connection is not proper or it is not the live cable at all.



For N (Neutral cable)

Turn the digital multimeter to 750V AC, use your one hand to hold the metal end, and then the other hand insert the pen to the N port of the socket. See the following figure. If the multimeter shows 0, then you can see current N cable connection is standard. If the value is more than 10, then you can see there is inductive current and the neutral cable connection is not proper. If the value is 120, then you can know misconnected the neutral cable to the live cable.

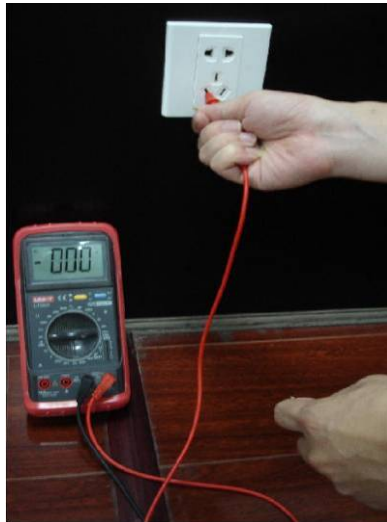

Appendix H RAID Introduction

Appendix H-1 About RAID

RAID is an abbreviation for Redundant Array of Independent Disks.

It is to combine several independent HDDs (physical HDD) to form a HDD group (logic HDD) to provide more storage capacity and data redundancy. **Right now system supports RAID0/RAID1/RAID5/RAID10.** Each level has different data protection, data usage and performance levels. Please refer to the following sheet for detailed information.

Appendix H-2 RAID Level

RAID Level	Note	Min HDD Needed
RAID0	<ul style="list-style-type: none">● RAID0 has no redundancy and no verification function. RAID0 has at least two HDDs. It uses two HDDs (or more) to one and the data is saved in each HDD. The read-write speed multiples since the bandwidth multiples. Theoretically speaking, the speed of the RAID0 is the N of the each HDD. The security level decrease N since the data is saved in different HDD blocks instead of saving in one HDD. That is to say, once any of the HDD is damaged, system loses all data.● RAID0 just purely enhances read-write performance while there is no data security guarantee. So, RAID0 is the most vulnerable RAID type and there is no redundancy function. Any HDD physical malfunction may affect all data. So, RAID 0 is not for the environment of high data security requirements.	2
RAID1	<ul style="list-style-type: none">● RAID1 is a safe RAID mode. It realizes data redundancy function via HDD data mirroring, so there are backup data on these two HDDs respectively. When one HDD is malfunction, system can read data from the other HDD. So RAID 1 presents high redundant function. But the write performance may be low since the data needs to be written twice. RAID1 is an ideal option for the environment of high security concern instead of the speed.● RAID1 has the highest unit cost in all the RAID types. But it provides general high data security and operation function. When one physical HDD is malfunction, system can auto switch to the mirroring HDD to read and write instead of rebuilding the invalid data.● When one HDD is malfunction, you can just replace the damaged HDD. If the other HDD is damaged too before	2

RAID Level	Note	Min HDD Needed
	<p>you replace the first HDD, then the RAID1 is null. Because the data in the first malfunction HDD is not complete, system can not rebuild the data based on the first damaged HDD. Now you need to use the second malfunction HDD, usually you can get the all data again.</p>	
RAID5	<ul style="list-style-type: none"> ● RAID5 is a widely used RAID level. It needs to have at least three HDDs. It has two aspects into consideration: data security and HDD usage level. One malfunction HDD does not terminate service since the data is reading from the odd/even verification block. RAID5 is suitable for archiving and users have high demands of the performance and uninterrupted data access such as video editor. ● When data in one of the HDDs is damaged, system can use the rest data and corresponding verification information to restore the lost data on the newly replaced HDD. Once another HDD is malfunction before the data be rebuilt on the newly replaced HDD, all data in the RAID5 will lose permanently. ● About read/write performance, it is generally low since each write operation needs to calculate and write verification. But it has high read performance. Besides, each stripe group of the RAID5 has one stripe to write verification, all strips added together will use one physical HDD. That is to say, the space of the RAID5 logical HDD equals to all physical HDD space to minus one physical HDD space. 	3
RAID10	<ul style="list-style-type: none"> ● RAID1+0 is so called RAID10 standard. It integrates the features of RAID0 and RAID1, which makes it has the general advantages and disadvantages of RAID0 and RAID1 together. So it is secure and of high speed. ● RAID10 shall at least consist of four HDDs. It has the extra high speed of RAID0 and high data security level of RAID1. But the HDD usage level is low. RAID10 is mainly for the database of general small space but has high speed and tolerance control level. ● Actually, RAID10 is many groups of RAID1 to create RAID0. For each RAID1 group, it can tolerate one HDD offline. RAID10 is still valid if one HDD of the RAID1 group is malfunction while the data in the rest HDD is good. RAID10 is invalid once two HDDs of the one group of 	4

RAID Level	Note	Min HDD Needed
	RAID1 are damaged at the same time.	

Appendix H-3 RAID Capacity Calculation

RAID Name	Total Space of the N disks.
RAID0	The total amount of $N \times \text{HDD} = \text{HDD space} \times \text{HDD amount}$.
RAID1	$\text{Min}(\text{capacityN})$
RAID5	$(N-1) \times \text{min}(\text{capacityN})$
RAID10	$(N/2) \times \text{min}(\text{capacityN})$
Note capacityN refers to the disk of mini space among all the member HDDs.	

Appendix H-4 RAID Usage Suggestions

- For the environment of high HDD read-write speed and no security requirements, you can use RAID0. Please note RAID0 is the most vulnerable level and has no redundant function. System loses all data once any HDD becomes malfunction.
- For the environment of high security level and no HDD read-write speed requirements, please use RAID1.
- For the environment of high security level and HDD read-write speed at the same time, please use RAID5.
- Always use the HDD of the same brand in case there is high HDD read-write speed difference. For RAID1/RAID5/RAID10, the HDD shall be of the same space and of the same model. It is to utmost exert the HDD usage rate and performance.

Appendix I RJ45-RS232 Connection Cable Definition

Here we are going to make standard RS232 port and standard RJ45 (T568B).

Please refer to the following figure for RJ45 cable definition.



Please refer to the following figure for RS232 pin definition.

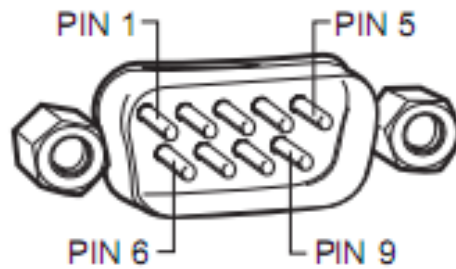

Please refer to the following figure for connection information.

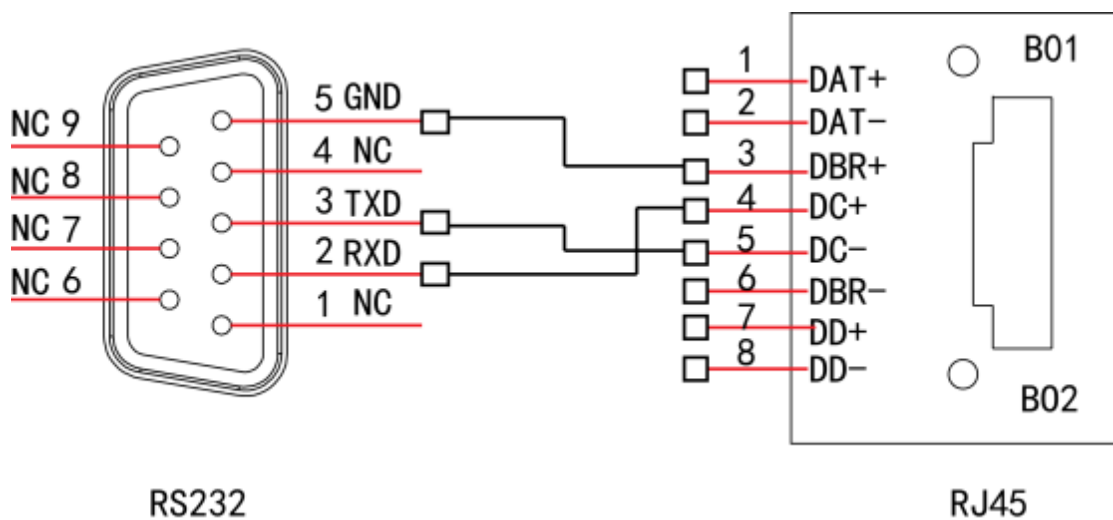

Please refer to the following sheet for detailed crossover cable connection information.

RJ45 (T568B)	RJ45 (Network cable)	RS232	Signal Description
--------------	-----------------------	-------	--------------------

4	Blue	2	RXD
5	White and blue	3	TXD
3	White and green	5	GND

Please refer to the following figure for straight cable connection information.

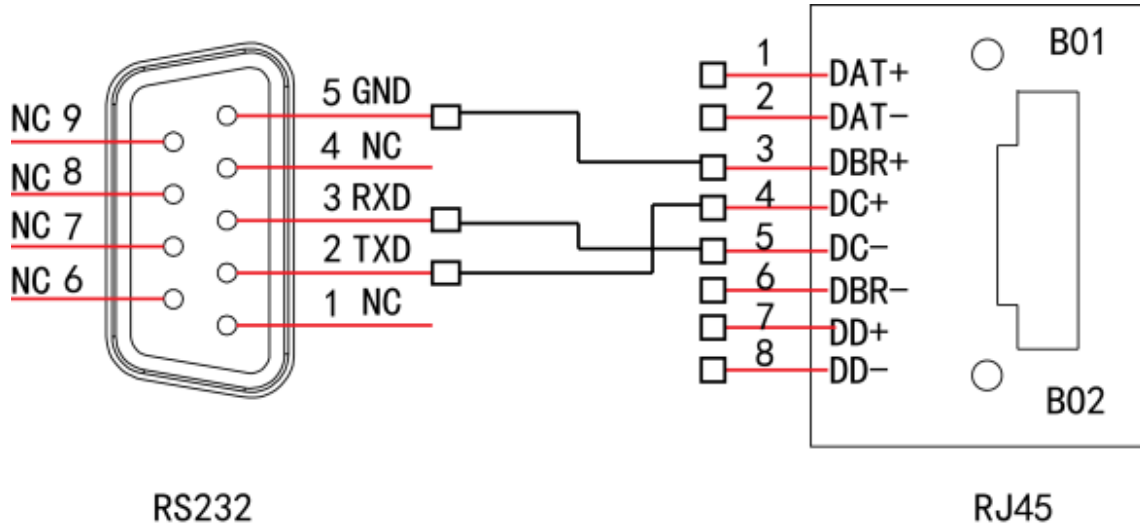

Please refer to the following sheet for straight connection information.

RJ45 (T568B)	RJ45 (Network cable)	RS232	Signal Description
4	Blue	3	RXD
5	White and blue	2	TXD
3	White and green	5	GND

Note:

- This manual is for reference only. Slight difference may be found in the user interface.
- All the designs and software here are subject to change without prior written notice.
- All trademarks and registered trademarks mentioned are the properties of their respective owners.
- If there is any uncertainty or controversy, please refer to the final explanation of us.
- Please visit our website or contact your local retailer for more information.