

**ICREALTIME Hybrid Standalone DVR
User's Manual**

V1.1.0

Table of Contents

1	FEATURES AND SPECIFICATIONS	1
1.1	Overview	1
1.2	Features.....	1
1.3	Specifications.....	2
2	OVERVIEW AND CONTROLS	7
2.1	Front Panel.....	7
2.2	Rear Panel.....	9
2.3	Connection Sample.....	10
2.4	Remote Control.....	11
2.5	Mouse Control.....	13
2.6	Virtual Keyboard & Front Panel.....	15
2.6.1	Virtual Keyboard	15
2.6.2	Front Panel	15
3	INSTALLATION AND CONNECTIONS	16
3.1	Check Unpacked DVR.....	16
3.2	About Front Panel and Real Panel	16

3.3	HDD Installation.....	16
3.4	Rack Installation	17
3.5	Connecting Power Supply.....	17
3.6	Connecting Video Input and Output Devices	17
3.6.1	Connecting Video Input	17
3.6.2	Connecting Video Output	18
3.7	Connecting Audio Input & Output, Bidirectional Audio	19
3.7.1	Audio Input.....	19
3.7.2	Audio Output.....	19
3.8	Alarm Input and Output Connection	20
3.8.1	Alarm Input and Output Details.....	21
3.8.2	Alarm Input Port	22
3.8.3	Alarm Output Port	22
3.9	RS485	23
3.10	Other Interfaces	23
4	OVERVIEW OF NAVIGATION AND CONTROLS.....	25
4.1	Login, Logout & Main Menu.....	25
4.1.1	Login	25
4.1.2	Main Menu	26
4.1.3	Logout.....	26
4.1.4	Auto Resume after Power Failure	27
4.1.5	Replace Button Battery	27
4.2	Manual Record.....	27
4.2.1	Live Viewing	27
4.2.2	Manual record	28

4.3	Search & Playback.....	30
4.4	Schedule.....	33
4.4.1	Schedule Menu	33
4.4.2	Snapshot.....	35
4.4.3	Image FTP	37
4.4.4	Snapshot Disk (For special series only).....	37
4.5	Detect.....	38
4.5.1	Go to Detect Menu.....	38
4.5.2	Motion Detect.....	38
4.5.3	Video Loss	41
4.5.4	Camera Masking.....	41
4.6	Alarm Setup and Alarm Activation	42
4.6.1	Go to alarm setup interface.....	42
4.6.2	Alarm setup.....	42
4.7	Backup	44
4.7.1	Detect Device	44
4.7.1	Backup.....	45
4.8	PTZ Control and Color Setup	46
4.8.1	Cable Connection	46
4.8.2	PTZ Setup.....	46
4.8.3	3D Intelligent Positioning Key	48
4.9	Preset/ Patrol/Pattern/Scan	48
4.9.1	Preset Setup	49
4.9.2	Activate Preset	49
4.9.3	Patrol setup (Tour Setup).....	50
4.9.4	Activate Patrol (tour).....	50
4.9.5	Pattern Setup.....	50
4.9.6	Activate Pattern Function.....	50
4.9.7	Auto Scan Setup	50
4.9.8	Activate Auto Scan.....	51
4.10	Flip.....	51

5	UNDERSTANDING OF MENU OPERATIONS AND CONTROLS	52
5.1	Menu Tree	52
5.2	Main Menu.....	52
5.3	Setting.....	53
5.3.1	General.....	53
5.3.2	Encode	55
5.3.3	Schedule	56
5.3.4	RS232.....	56
5.3.5	Network	57
5.3.6	Alarm	66
5.3.7	Detect	66
5.3.8	Pan/Tilt/Zoom	66
5.3.9	Display.....	67
5.3.10	Default	69
5.4	Search.....	70
5.5	Advanced.....	70
5.5.1	HDD Management.....	70
5.5.2	Abnormity.....	74
5.5.3	Alarm Output	74
5.5.4	Manual Record.....	75
5.5.5	Account	75
5.5.6	Auto Maintain	77
5.5.7	TV Adjust.....	78
5.5.8	Video Matrix.....	78
5.5.9	Remote Device.....	79
5.5.10	Text Overlay	80
5.5.11	Config File Backup.....	82
5.6	Information.....	82
5.6.1	HDD Information	83
5.6.2	BPS.....	84
5.6.3	Log	84
5.6.4	Version	85
5.6.5	Online Users.....	86

5.7	Shutdown.....	86
6	ABOUT AUXILIARY MENU	88
6.1	Go to Pan/Tilt/Zoom Menu.....	88
6.1.1	3D Intelligent Positioning Key	88
6.2	Preset /Patrol / Pattern /Border Function.....	89
6.2.1	Preset Setup.....	90
6.2.2	Activate Preset.....	90
6.2.3	Patrol Setup.....	90
6.2.4	Activate Patrol	90
6.2.5	Pattern Setup	90
6.2.6	Activate Pattern Function	91
6.2.7	Border Setup	91
6.2.8	Activate Border Function	91
6.2.9	Flip	91
7	WEB CLIENT OPERATION.....	93
7.1	Network Connection.....	93
7.2	Login.....	93
7.2.1	Real-time Monitor	96
7.2.2	PTZ	98
7.2.3	Color	100
7.2.4	Picture Path and Record Path	101
7.3	Configure	102
7.3.1	System Information.....	102
7.3.2	System Configuration.....	104
7.3.3	Advanced	125
7.3.4	Additional Function	132
7.4	Search.....	134

7.5	Alarm	138
7.6	About	139
7.7	Log out	139
7.8	Un-install Web Control.....	140
8	PROFESSIONAL SURVEILLANCE SYSTEM.....	141
9	FAQ	142
	APPENDIX A HDD CAPACITY CALCULATION	147
	APPENDIX B COMPATIBLE BACKUP DEVICES	149
	Appendix B-1 Compatible USB list.....	149
	Appendix B-2 Compatible SD Card list.....	150
	Appendix B-3 Compatible Portable HDD list.....	150
	Appendix B-4 Compatible USB DVD List	150
	Appendix B-5 Compatible SATA DVD List	150
	Appendix B-6 Compatible SATA HDD List.....	151
	APPENDIX C COMPATIBLE CD/DVD BURNER LIST.....	154

APPENDIX D COMPATIBLE DISPLAYER LIST	155
APPENDIX E COMPATIBLE SWITCHER	156
APPENDIX F COMPATIBLE WIRELESS MOUSE LIST.....	157
APPENDIX G EARTHING	158
APPENDIX H TOXIC OR HAZARDOUS MATERIALS OR ELEMENTS.....	164

Welcome

Thank you for purchasing our DVR!

This user's manual is designed to be a reference tool for the installation and operation of your system.

Here you can find information about this series hybrid standalone DVR features and functions, as well as a detailed menu tree.

Before installation and operation please read the following safeguards and warnings carefully!

Important Safeguards and Warnings

1 . Electrical safety

All installation and operation here should conform to your local electrical safety codes. We assume no liability or responsibility for all the fires or electrical shock caused by improper handling or installation.

2 . Transportation security

Heavy stress, violent vibration or water splash are not allowed during transportation, storage and installation.

3 . Installation

Keep upwards. Handle with care.

Do not apply power to the DVR before completing installation.

Do not place objects on the DVR

4 . Qualified engineers needed

All the examination and repair work should be done by the qualified service engineers.

We are not liable for any problems caused by unauthorized modifications or attempted repair.

5 . Environment

The DVR should be installed in a cool, dry place away from direct sunlight, inflammable, explosive substances and etc.

6. Accessories

Be sure to use all the accessories recommended by manufacturer.

Before installation, please open the package and check all the components are included.

Contact your local retailer ASAP if something is broken in your package.

7. Lithium battery

Improper battery use may result in fire, explosion, or personal injury!

When replace the battery, please make sure you are using the same model!

1 FEATURES AND SPECIFICATIONS

1.1 Overview

The hybrid standalone series DVR is an excellent digital monitor product designed for security field.

It adopts embedded Linux OS to maintain reliable operation. Popular H.264 compression algorithm and G.711 audio compression technology realize high quality, low bit stream. Unique frame by frame play function is suitable for detailed analysis. It has various functions such as record, playback, monitor at the same time and can guarantee audio video synchronization. This series product has advanced technology and strong network data transmission function.

This series device adopts embedded design to achieve high security and reliability. It can work in the local end, and at the same time, when connecting it to the professional surveillance software (PSS), it can connect to the security network to realize strong network and remote monitor function.

This series product can be widely used in various areas such as banking, telecommunication, electric power, interrogation, transportation, intelligent resident zone, factory, warehouse, resources, and water conservancy.

1.2 Features

This series product has the following features:

- **Analog and digital mixed input**

Support analog and digital signal simultaneously. It can connect to multiple-channel high definition IPC.

- **Real-time surveillance**

Support analog output port, VGA port and HDMI port. Realize the surveillance through the monitor or displayer. Support HDMI, VGA, and TV output at the same time.

- **Storage function**

Special data format to guarantee data security and can remove the risk of the vicious data modification. Support digital watermark.

- **Compression format**

Support multiple-channel audio and video. An independent hardware decodes the audio and video signal from each channel to maintain video and audio synchronization.

- **Backup function**

Support backup operation via USB port (such as U disk, portable HDD, burner)

Client-end user can download the file to local HDD to backup via network.

- **Record & playback function**

Support each channel real-time record independently, and at the same time it can support search, forward play, network monitor, record search, download and etc.

Support various playback modes: slow play, fast play, backward play and frame by frame play.

Support time title overlay so that you can view event accurate occurred time

Support customized zoom function during the preview.

- **Network operation**

Support network remote real-time monitor, remote record search and remote PTZ control.

- **Alarm activation function**

Several relay alarm outputs to realize alarm activation and on-site light control.

The alarm input port and output has the protection circuit to guarantee device safety.

- **Communication port**

RS485 port can realize alarm input and PTZ control.

RS232 port can connect to keyboard to realize central control, and can also connect to PC COM to upgrade system and realize maintenance, and matrix control.

Standard Ethernet port can realize network access function.

The dual-network port has the multiple-access, fault-tolerance, load-balance setup mode.

- **PTZ control**

Support PTZ decoder via RS485.

Support various decode protocols to allow the PTZ to control the speed dome.

- **Intelligent operation**

Mouse operation function

In the menu, support copy and paste setup function

- **UPNP (Universal Plug and Play)**

Establish mapping connection between LAN and WAN via UPNP protocol.

Slight function differences may be found due to different series.

1.3 Specifications

	Parameter	4-ch	8-ch	16-ch
System	Main Processor	High-performance industrial embedded micro controller		
	OS	Embedded LINUX		

	System Resources	Multiplex operations: Multiple-channel record, multiple-channel playback and network operation simultaneously		
	Interface	User-friendly graphical user interface		
	Input Devices	Front panel, USB mouse, remote control		
	Input Method	Arabic number, English character, donation and extension Chinese (optional)		
	Shortcut Function	Copy/paste operation, USB mouse right-key shortcut menu, double click USB mouse to switch screen.		
Compression Standard	Video Compression	H.264		
	Audio Compression	G.711		
Video monitor	Video Input	4-CH composite video input: (NTSC/PAL) BNC (1.0V _{P-P} , 75Ω)	8-CH composite video input: (NTSC/PAL) BNC (1.0V _{P-P} , 75Ω)	16-CH composite video input: (NTSC/PAL) BNC (1.0V _{P-P} , 75Ω)
	Video Output	1-ch PAL/NTSC, BNC (1.0V _{P-P} , 75Ω) composite video signal output. 1-ch VGA output. 1-ch HDMI output. 1-ch matrix output. Support TV/VGA/HDMI video output at the same time.		
	Video Standard	PAL (625 line, 50f/s), NTSC (525 line, 60f/s)		
	Record Speed	Real-time Mode: PAL 1f/s to 25f/s per channel and NTSC 1f/s to 30f/s per channel		
	Video Partition	1/4/8/9 windows(Optional)	1/4/8/9 windows	1/4/8/9/16/25/36 windows
	Monitor Touring	Support monitor tour functions such as alarm, motion detection, and schedule auto control.		
	Resolution (PAL/NTSC)	PAL (625TV Line, 50f/s), NTSC (525TV line, 60f/s)		
		Real-time monitor: D1 704×576/704×480		
		Playback: 1/16-ch: D1 704×576/704×480, CIF 352×288/ 352×240, QCIF 176×144/176×120.		
	Motion Detection	Zone setup: support max 396(22×18) zones. Support various sensitivities.		
Image Quality	6-level image quality (Adjustable)			

	Privacy mask	Support one privacy mask of user-defined size in full screen. Support max 4 zones.		
	Image Information	Channel information, time information and privacy mask zone.		
	TV Adjust	Adjust TV output zone suitable to anamorphic video.		
	Channel Lock	Cover secret channel with blue screen though system is encoding normally. Screen-lock function to prevent unauthorized user seeing secret video.		
	Channel Information	Channel name, recording status, screen lock status, video loss status and motion detection status are shown on the bottom left of display screen.		
	Color Configuration	Hue, brightness, contrast, saturation and gain setup for each channel.		
Audio	Audio Input	4-ch 200-2000mv 10KΩ(BNC)	8-ch 200-2000mv 10KΩ(BNC)	16-ch 200-2000mv 10KΩ (BNC)
		There is a special series of 4-channel 200-2000mV 10KΩ (BNC).		
	Audio Output	1-ch audio output 200-3000mv 5KΩ(BNC)		
	Bidirectional Audio	1- ch audio input 200-3000mv 10KΩ(BNC) 1- ch audio output 200-3000mv 5KΩ(BNC)		
Hard disk	Hard Disk	8 built-in SATA port. Support 8 HDD.		
	Hard Disk Occupation	Audio: PCM 28.8MByte/h Video: 56-900MByte/h		
Record and playback	Recording Mode	Manual recording, motion detection recording, schedule recording and alarm recording Priority: Manual recording> alarm recording>motion detection recording>schedule recording.		
	Recording Length	1 to 120 minutes single record duration (Default setup is 60 minutes)		
	Playback Repeat Way	When hard disk is full, system can overwrite previous video file.		
	Record Search	Various search engines such as time, type and channel.		
	Playback Mode	Various fast play, slow play speeds, manual frame by frame playback and reverse play mode.		
	Various File Switch Ways	Can switch to previous or next file or any file in current play list. Can switch to file on other channel of the same time. (If there is a file) Support file continuous play, when file is end system auto plays the next file in the current channel		
	Multi-channel Playback	Support single channel, 4 channel, 9 channel and 16 channel modes		

	Window Zoom	Switch between self-adaptive screen/full screen when playback		
	Partial Enlargement	When in one-window full-screen playback mode, you can select any zone to activate partial enlargement function.		
Backup function	Backup Mode	HDD backup		
		Support peripheral USB backup device. (Flash disk, portable disk, USB burner and etc.)		
		Support external eSATA device backup		
		Support network download and backup		
Network Function	Network control	View monitor channel remotely.		
		DVR configuration through client-end and web browser		
		Upgrade via client or browser to realize remote maintenance.		
		View alarm information such as external alarm, motion detection and video loss via client.		
		Support network PTZ lens control		
		File download backup and playback		
		Multiple devices share information via corresponding software such as professional surveillance software (PSS)		
		Duplex transparent COM		
		Network alarm input and output		
		Bidirectional audio.		
Motion Detection and Alarm	Motion Detection	Zone setup: support 396((PAL 22×18, NTSC 22×15)) detection zones. Various sensitivity levels. Alarm can activate record or external alarm or screen message prompt.		
	Video Loss	Alarm can activate external alarm or screen message prompt.		
	External Alarm	Support record activation function or activate external alarm or screen message in specified period.		
	Manual Alarm Control	Enable or disable alarm input channel Support analog alarm signal to specific alarm output channel.		
	Alarm Input	4-ch alarm input (You can set normal open or normal close type to select the alarm type.)	8-ch alarm input (You can set normal open or normal close type to select the alarm type.)	16-ch alarm input (You can set normal open or normal close type to select the alarm type.)
	Alarm Output	6-channel relay output. (one of them can control DC+12v output)		
	Alarm Relay	30VDC 2A, 125VAC 1A (activation alarm)		
Interface	USB Interface	4 USB 2.0 ports.		
	Network connection	RJ45 10M/100M/1000M self-adaptable Ethernet port		
	RS485	PTZ control port Support various PTZ control protocols.		

	RS232	Ordinary COM (Debug),keyboard connection and transparent serial port(COM input and output via network)
System Information	Hard Disk Information	Display HDD current status
	Data Stream Statistics	Data stream statistics for each channel (in wave mode)
	Log statistics	Backup to 1024 log files. Support various search engines such as time and type.
	Version	Display version information: channel amount, alarm input and output amount, system version and release date.
	On-line user	Display current on-line user
User Management	User Management	Multi-lever user management; various management modes Integrated management for local user, serial port user and network user. Configurable user power.
		Support user /group and its corresponding rights modification. No limit to the user or group amount.
	Password Authentication	Password modification Administrator can modify other user's password.
		Account lock strategy Five times login failure in thirty minutes may result in account lock.
Upgrade		Web browser, client-end and update tool.
Login, Logout and Shutdown		Password login protection to guarantee safety
		User-friendly interface when login. Provide the following options: Logout /shutdown/ restart.
		Right authentication when shut down to make sure only those proper people can turn off DVR
General Parameter	Power	AC90~264V 50+2% Hz(Max. 220W)
	Power Consumption	25W (Exclude HDD)
	Working Temperature	0℃ — +55℃
	Working Humidity	10%—90%
	Air Pressure	86kpa—106kpa
	Dimension	2U standard industrial case. 440(W) x460(D) x89(H)mm
	Weight	6.5—7.5KG (Exclude HDD)
	Installation Mode	Desktop/rack installation

2 Overview and Controls

This section provides information about front panel and rear panel. When you install this series DVR for the first time, please refer to this part first.

2.1 Front Panel

This series products' front panel is shown as below. See Figure 2-1.

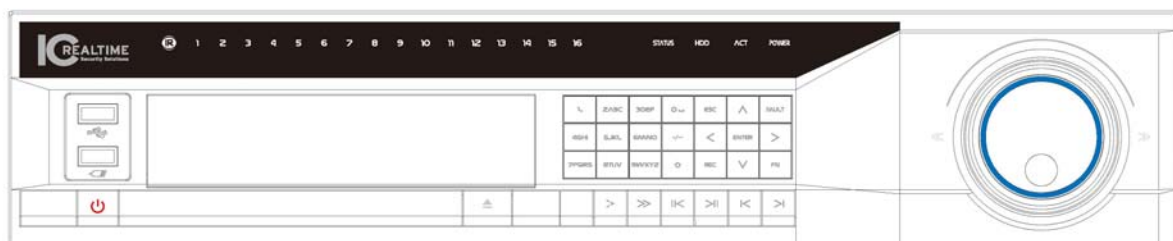











Figure 2-1

Please refer to the following sheet for front panel button information.

Name	Icon	Function
Power button		Power button, press this button for three seconds to boot up or shut down DVR.
Number and Character	0	In text mode, input number 0. It is the space button.
	1,.	In text mode, input number 1 and denotation.
	2ABC	In text mode, input number 2(English character A/B/C)
	3DEF	In text mode, input number 3(English character D/E/F)
	4GHI	In text mode, input number 4 (English character G/H/I)
	5JKL	In text mode, input number 5(English character J/K/L).
	6MNO	In text mode, input number 6 (English character M/N/O)
	7PQRS	In text mode, input number 7 (English character P/Q/R/S).
	8TUV	In text mode, input number 8 (English character T/U/V).
	9WXYZ	In text mode, input number 9 (English character W/X/Y/Z)
	-/--	If you want to input a number more than 10, please click this button and then input.
Shift		In textbox, click this button to switch between numeral, English(Small/Capitalized),donation and etc.
Up Down		Activate current control, modify setup, and then move up and down.
		Increase/decrease numeral.

		Assistant function such as PTZ menu.
Left Right		Shift current activated control,
		When playback, click these buttons to control playback bar.
ESC	ESC	Go to previous menu, or cancel current operation.
		When playback, click it to restore real-time monitor mode.
Enter	ENTER	Confirm current operation
		Go to default button
		Go to menu
Record	REC	Manually stop/start recording, working with direction keys or numeral keys to select the recording channel.
Window switch	Mult	Click it to switch one-window/multiple-window.
Slow play/8		Multiple slow play speeds or normal playback.
Assistant	Fn	One-window monitor mode, click this button to display assistant function: PTZ control and image color.
		Backspace function: in numeral control or text control, press it for 1.5seconds to delete the previous character before the
		In motion detection setup, working with Fn and direction keys to realize setup.
		In text mode, click it to switch between numeral, English character(small/capitalized) and etc.
		Realize other special functions.
Fast play		Various fast speeds and normal playback.
Play previous		In playback mode, playback the previous video
Reverse/Pause		In normal playback or pause mode, click this button to reverse playback In reverse playback, click this button to pause playback.
Play Next		In playback mode, playback the next video In menu setup, go to down ward of the dropdown list.
Play/Pause		In normal playback click this button to pause playback In pause mode, click this button to resume playback.

USB port		To connect USB storage device, USB mouse.
Status indication light	Status	If there is Fn indication light, current status indication light is null.
HDD abnormal	HDD	HDD error occurs or HDD capacity is below specified threshold value, the light becomes red to alert you.
Remote control indication light	ACT	Remote control indication light
Power indication light	Power	Power indication light
Record light	1-16	System is recording or not. It becomes on when system is recording.
IR Receiver	IR	It is to receive the signal from the remote control.
Shuttle(outer ring)		In real-time monitor mode it works as left/right direction key. Playback mode, counter clockwise to forward and clock wise to backward.
Jog(inner dial)		Up/down direction key. Playback mode, turn the inner dial to realized frame by frame playback. (Only applies to some special versions.)
CD-ROM button		Pop-up or insert the CD.

2.2 Rear Panel

This series products' rear panel is shown as below. See Figure 2-2.

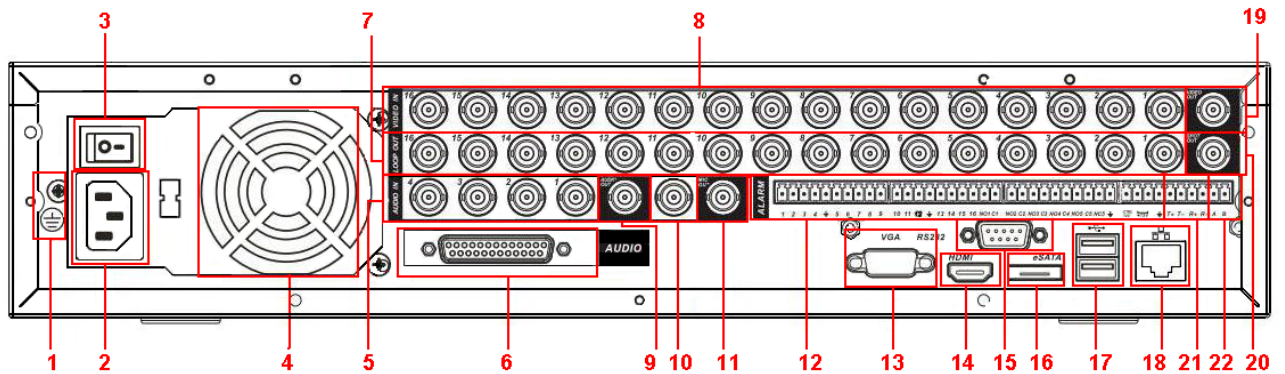

Figure 2-2

Please refer to the following sheet for detailed information.

1	Grounding hole
2	Power input port
3	Power button
4	Fan
5	The 1st to the 4th-channel audio input
6	DB25 port (the 5th to the 16th-channel audio input port)
7	Loop video output
8	Video input
9	Audio output
10	Bidirectional talk input port
11	Bidirectional talk output port
12	Alarm input/alarm output
13	Video VGA output
14	HDMI port
15	RS-232 port
16	eSATA port
17	USB port
18	Network port
19	Video CVBS output
20	Video matrix output
21	Full-duplex RS-485 port
22	Semi-duplex RS-485 port

When connect the Ethernet port, please use crossover cable to connect the PC and use the straight cable to connect to the switcher or router.

2.3 Connection Sample

Please refer to the following figure for detailed information. See Figure 2-3.

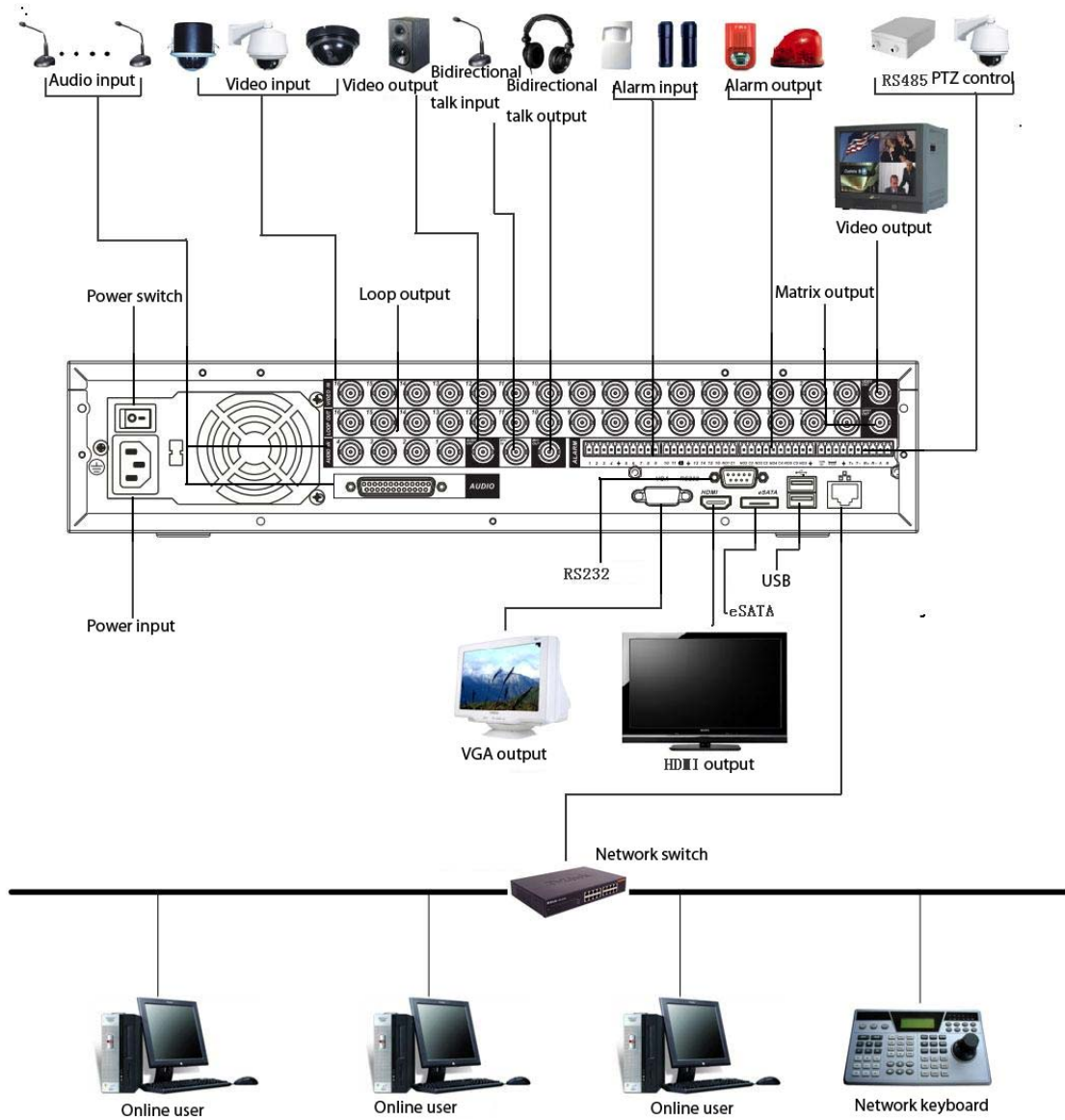

Figure 2-3

2.4 Remote Control

The remote control interface is shown as in Figure 2-4.

Please note remote control is not our standard accessory and it is not included in the accessory bag.

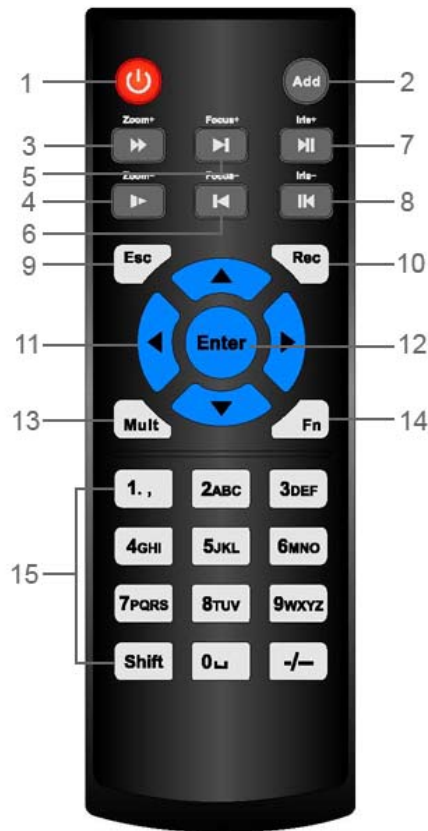

Figure 2-4

Serial Number	Name	Function
1	Power button	Click it to boot up or shut down the device.
2	Address	Click it to input device number, so that you can control it.
3	Forward	Various forward speeds and normal speed playback.
4	Slow play	Multiple slow play speeds or normal playback.
5	Next record	In playback mode, playback the next video.
6	Previous record	In playback mode, playback the previous video.
7	Play/Pause	In pause mode, click this button to realize normal playback. In normal playback click this button to pause playback. In real-time monitor mode, click this button to enter video search menu.
	Reverse/pause	Reverse playback pause mode,

8		click this button to realize normal playback.
		In reverse playback click this button to pause playback.
9	Esc.	Go back to previous menu or cancel current operation (close upper interface or control)
10	Record	Start or stop record manually In record interface, working with the direction buttons to select the record channel. Click this button for at least 1.5 seconds, system can go to the Manual Record interface.
11	Direction keys	Switch current activated control, go to left or right. In playback mode, it is to control the playback process bar. Aux function(such as switch the PTZ menu)
12	Enter /menu key	go to default button go to the menu
13	Multiple-window switch	Switch between multiple-window and one-window.
14	Fn	In 1-ch monitor mode: pop up assistant function: PTZ control and Video color.
		Switch the PTZ control menu in PTZ control interface.
		In motion detection interface, working with direction keys to complete setup.
15	0-9 number key	Input password, channel or switch channel.
		Shift is the button to switch the input method.

2.5 Mouse Control

Left click mouse	System pops up password input dialogue box if you have not logged in. In real-time monitor mode, you can go to the main menu.
------------------	--

	<p>When you have selected one menu item, left click mouse to view menu content.</p> <p>Implement the control operation.</p> <p>Modify checkbox or motion detection status.</p> <p>Click combo box to pop up drop down list</p> <p>In input box, you can select input methods. Left click the corresponding button on the panel you can input numeral/English character (small/capitalized). Here ← stands for backspace button. _ stands for space button.</p> <p>In English input mode: _stands for input a backspace icon and ← stands for deleting the previous character.</p> <div data-bbox="496 712 1118 927" data-label="Image"> </div> <p>In numeral input mode: _ stands for clear and ← stands for deleting the previous numeral.</p> <p>When input special sign, you can click corresponding numeral in the front panel to input. For example, click numeral 1 you can input“/” , or you can click the numeral in the on-screen keyboard directly.</p> <div data-bbox="715 1263 911 1438" data-label="Image"> </div>
<p>Double left click mouse</p>	<p>Implement special control operation such as double click one item in the file list to playback the video.</p> <p>In multiple-window mode, double left click one channel to view in full-window.</p> <p>Double left click current video again to go back to previous multiple-window mode.</p>

Right click mouse	<p>In real-time monitor mode, pops up shortcut menu: one-window, four-window, nine-window and sixteen-window, Pan/Tilt/Zoom, color setting, search, record, alarm input, alarm output, main menu. Among which, Pan/Tilt/Zoom and color setting applies for current selected channel.</p> <p>If you are in multiple-window mode, system automatically switches to the corresponding channel.</p> 
	Exit current menu without saving the modification.
Press middle button	<p>In numeral input box: Increase or decrease numeral value.</p> <p>Switch the items in the check box.</p> <p>Page up or page down</p>
Move mouse	Select current control or move control
Drag mouse	<p>Select motion detection zone</p> <p>Select privacy mask zone.</p>

2.6 Virtual Keyboard & Front Panel

2.6.1 Virtual Keyboard

The system supports two input methods: numeral input and English character (small and capitalized) input.

Move the cursor to the text column, the text is shown as blue, input button pops up on the right. Click that button to switch between numeral input and English input (capitalized and small), Use > or < to shift between small character and capitalized character.

2.6.2 Front Panel

Move the cursor to the text column. Click Fn key and use direction keys to select number you wanted. Please click enter button to input.

3 Installation and Connections

Note: All the installation and operations here should conform to your local electric safety rules.

3.1 Check Unpacked DVR

When you receive the DVR from the forwarding agent, please check whether there is any visible damage. The protective materials used for the package of the DVR can protect most accidental clashes during transportation. Then you can open the box to check the accessories.

Please check the items in accordance with the list on the warranty card. Finally you can remove the protective film of the DVR.

Note

Remote control is not a standard accessory and it is not included in the accessory bag.

3.2 About Front Panel and Real Panel

The model in the front panel is very important; please check according to your purchase order.

The label in the rear panel is very important too. Usually we need you to represent the serial number when we provide the service after sales.

3.3 HDD Installation

This series DVR has 1 to 8 HDDs (no limitation for capacity). Please use HDD of 7200rpm or higher. Usually we do not recommend the HDD for the PC. You can refer to the Appendix for recommended HDD brand. Please follow the instructions listed below to install hard disk.



1. Loosen the screws of the upper cover.	2. Loosen HDD upper bracket	3. You can see the HDD lower support after loosening HDD upper bracket
--	-----------------------------	--

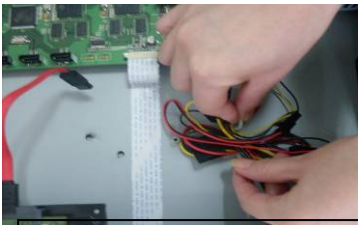
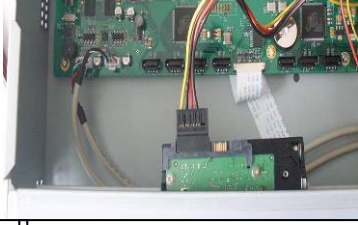
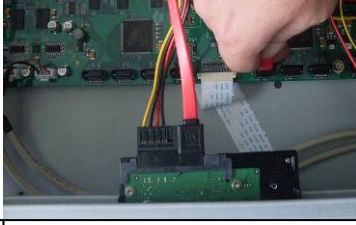

4. Place the HDD in accordance to the four holes on the lower bracket	5. Fix the HDD firmly with screws.	6. Install the upper support and fix it firmly. Fix the HDD to the HDD upper support in the same way.
		
7. Loosen the HDD power wire inside the DVR.	8. Insert the power wire	9. Connect HDD to SATA port with specified data line, then put the cover on the box and fix it firmly.

Note:

- You can connect the HDD data cable and the power cable first and then fix the HDD in the device.
- Please pay attention to the front cover. It adopts the vertical sliding design. You need to push the clip first and then put down.

3.4 Rack Installation

The DVR occupies 2U rack units of vertical rack space.

- Use twelve screws to fix the unit
- Please make sure the indoor temperature is below 35°C (95°F).
- Please make sure there is 15cm (6 inches) space around the device to guarantee sound ventilation.
- Please install from the bottom to the top.
- If there are more accessories connected in the rack, please take precaution measures in case the rack power is overload.

3.5 Connecting Power Supply

Please check input voltage and device power button match or not.

We recommend you use UPS to guarantee steady operation, DVR life span, and other peripheral equipments operation such as cameras.

3.6 Connecting Video Input and Output Devices

3.6.1 Connecting Video Input

The video input interface is BNC. The input video format includes: PAL/NTSC BNC (1.0V_{P-P}, 75Ω).

The video signal should comply with your national standards.

The input video signal shall have high SNR, low distortion; low interference, natural color and suitable lightness.

Guarantee the stability and reliability of the camera signal:

The camera shall be installed in a cool, dry place away from direct sunlight, inflammable, explosive substances and etc.

The camera and the DVR should have the same grounding to ensure the normal operation of the camera.

Guarantee stability and reliability of the transmission line

Please use high quality, sound shielded BNC. Please select suitable BNC model according to the transmission distance.

If the distance is too long, you should use twisted pair cable, and you can add video compensation devices or use optical fiber to ensure video quality.

You should keep the video signal away from the strong electromagnetic interference, especially the high tension current.

Keep connection lugs in well contact

The signal line and shielded wire should be fixed firmly and in well connection. Avoid dry joint, lap welding and oxidation.

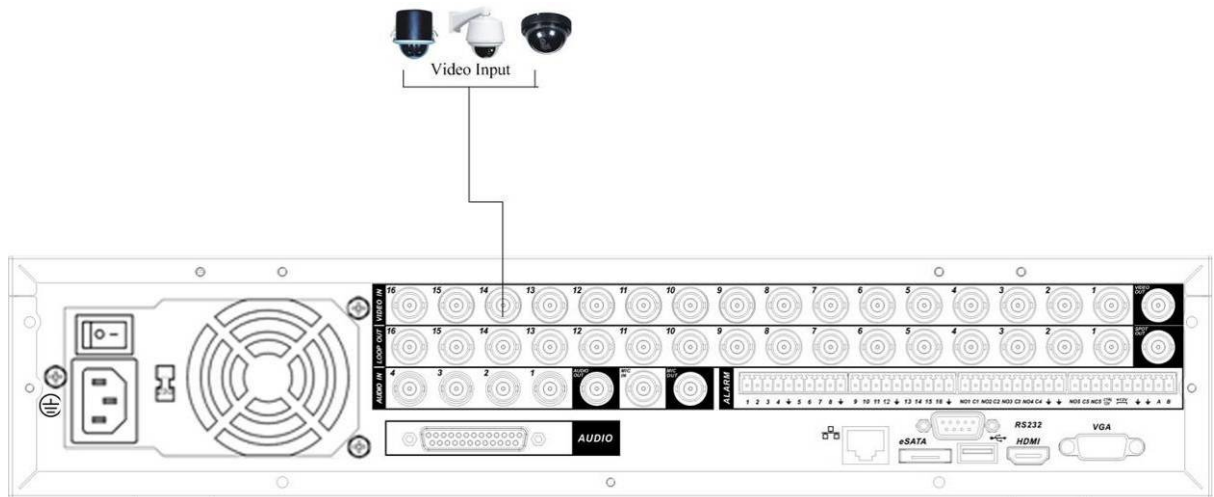

Figure 3-1

3.6.2 Connecting Video Output

Video output includes a BNC(PAL/NTSC, 1.0VP- P, 75Ω) output, a VGA output and a HDMI output.

System supports BNC, VGA and HDMI output at the same time.

When you are using pc-type monitor to replace the monitor, please pay attention to the following points:

- To defer aging, do not allow the pc monitor to run for a long time.
- Regular demagnetization will keep device maintain proper status.
- Keep it away from strong electromagnetic interference devices.

Using TV as video output device is not a reliable substitution method. You also need to reduce the working hour and control the interference from power supply and other devices. The low quality TV may result in device damage.

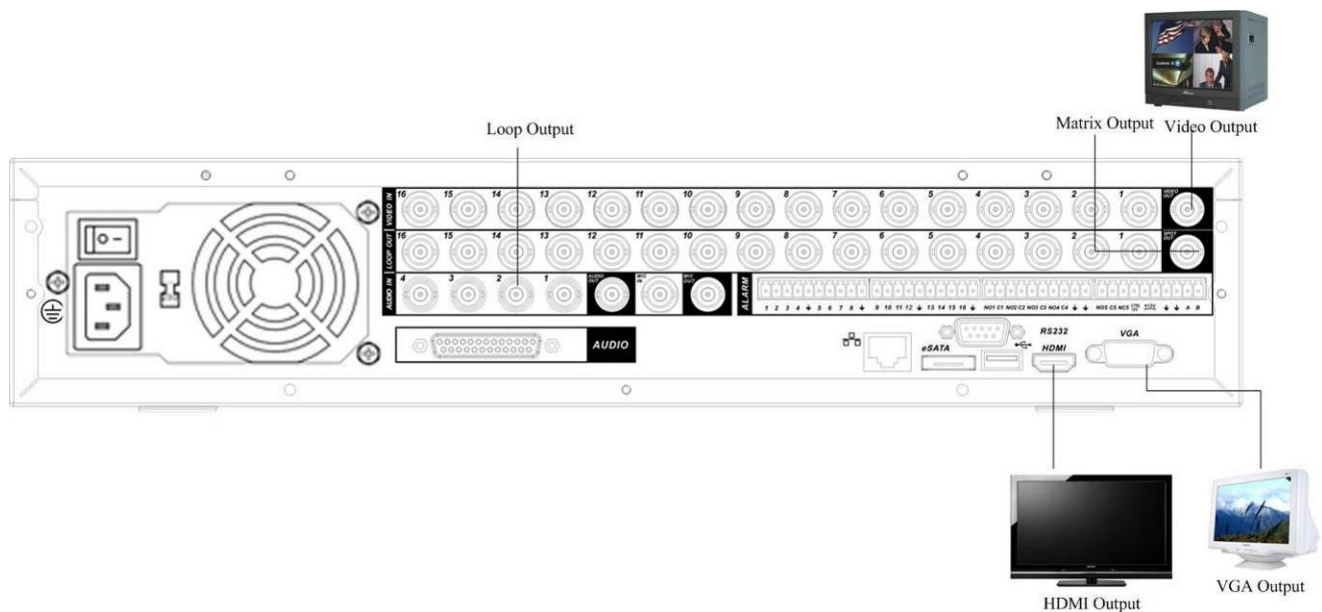

Figure 3-2

3.7 Connecting Audio Input & Output, Bidirectional Audio

3.7.1 Audio Input

BNC port is adopted for audio input port.

Due to high impedance of audio input, please use active sound pick-up.

Audio transmission is similar to video transmission. Try to avoid interference, dry joint, loose contact and it shall be away from high tension current.

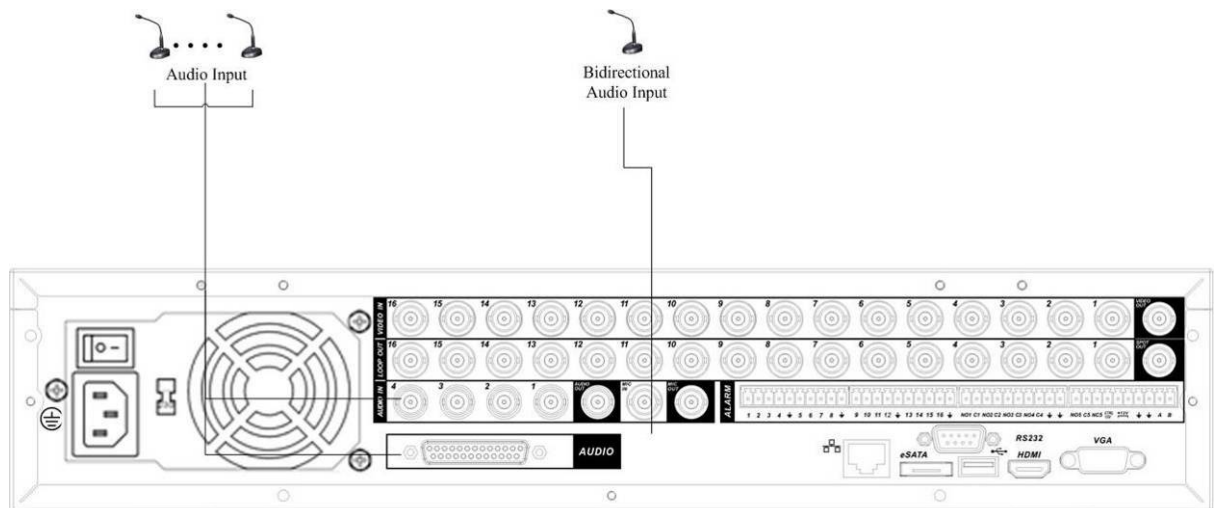

Figure 3-3

3.7.2 Audio Output

The audio output signal parameter is usually over 200mv 1KΩ (BNC). It can directly connect to low impedance earphone, active sound box or amplifier-drive audio output device.

If the sound box and the pick-up cannot be separated spatially, it is easy to arouse squeaking. In this case you can adopt the following measures:

- Use better sound pick-up with better directing property.

- Reduce the volume of the sound box.
- Using more sound-absorbing materials in decoration can reduce voice echo and improve acoustics environment.
- Adjust the layout to reduce happening of the squeaking.

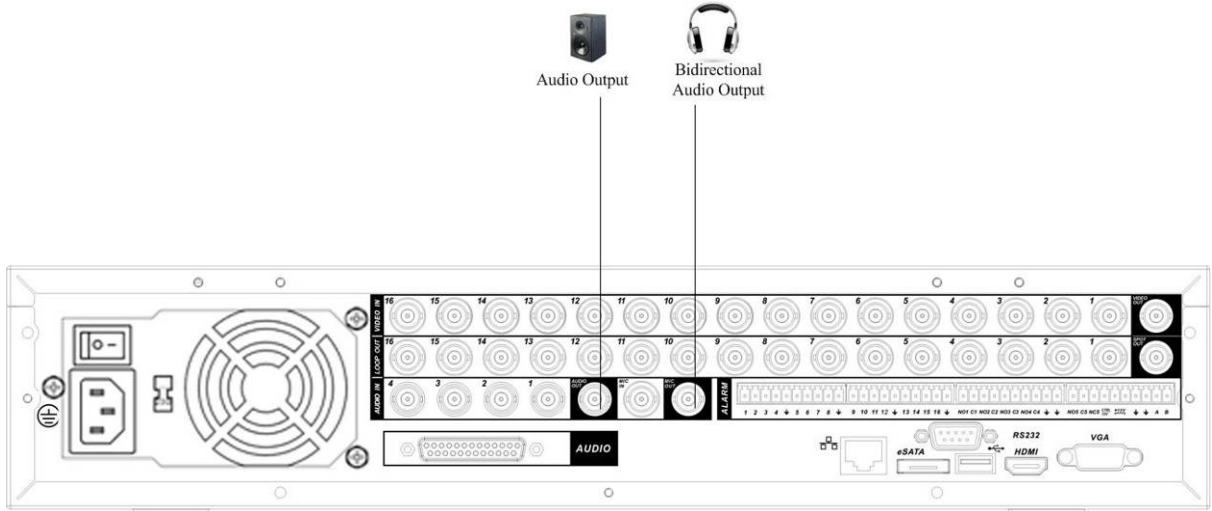

Figure 3-4

3.8 Alarm Input and Output Connection

The alarm input and output interface is shown as in Figure 3-5.

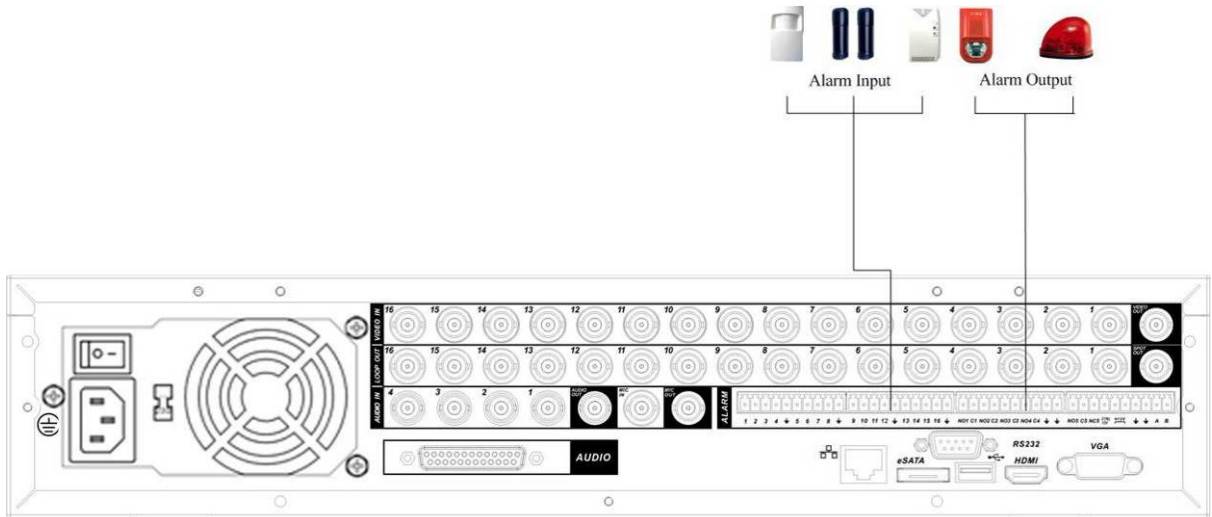

Figure 3-5

Please read the followings before connecting.

1. Alarm input

- Please make sure alarm input mode is grounding alarm input.
- Grounding signal is needed for alarm input.
- Alarm input needs the low level voltage signal.
- Alarm input mode can be either NC (normal Open) or NO (Normal Close)

e. When you are connecting two DVRs or you are connecting one DVR and one other device, please use a relay to separate them,

2. Alarm output

The alarm output port should not be connected to high power load directly (It shall be less than 1A) to avoid high current which may result in relay damage. Please use the contactor to realize the connection between the alarm output port and the load.

3. How to connect PTZ decoder

- Ensure the decoder has the same grounding with DVR, otherwise you may not control the PTZ. Shielded twisted wire is recommended and the shielded layer is used to connect to the grounding.
- Avoid high voltage. Ensure proper wiring and some thunder protection measures.
- For too long signal wires, 120Ω should be parallel connected between A, B lines on the far end to reduce reflection and guarantee the signal quality.
- “485 A, B” of DVR cannot parallel connect with “485 port” of other device.
- The voltage between of A,B lines of the decoder should be less than 5v.

4. Please make sure the front-end device has soundly earthed.

Improper grounding may result in chip damage.

3.8.1 Alarm Input and Output Details

Please refer to the Figure 3-6 and the following sheet for detailed information.



Figure 3-6

<p>In the first line, from the left to the right,:</p> <p>1, 2, 3, 4, 5, 6, 7, 8, 9, 10, 11, 12, 13, 14, 15, 16</p>	<p>ALARM 1 to ALARM 16. The alarm becomes active in low voltage.</p>
<p>In the second line, from the left to the right:</p> <p>NO1 C1, NO2 C2, NO3 C3, NO4 C4, NO5 C5 NC5</p>	<p>The first four are four groups of normal open activation output (on/off button)</p> <p>NO5 C5 NC5 is a group of NO/NC activation output (on/off button)</p>

CTRL 12V	Control power output. You need to close the device power to cancel the alarm.
+12V	It is external power input. Need the peripheral equipment to provide +12V power (below 1A).
	Earth cable.
485 A/B	485 communication port. They are used to control devices such as decoder.
T+,T-,R+,R-	They are four-wire double duplex RS485 port T+ T-: output wire R+ R-: input wire

3.8.2 Alarm Input Port

Please refer to the following sheet for more information.

- Grounding alarm inputs. Normal open or Normal close type)
- Please parallel connect COM end and GND end of the alarm detector (Provide external power to the alarm detector).
- Please parallel connect the Ground of the DVR and the ground of the alarm detector.
- Please connect the NC port of the alarm sensor to the DVR alarm input(ALARM)
- Use the same ground with that of DVR if you use external power to the alarm device.

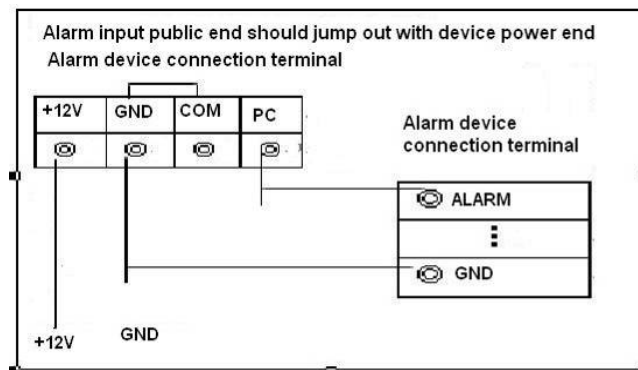

Figure 3-7

3.8.3 Alarm Output Port

- Provide external power to external alarm device.
- To avoid overloading, please read the following relay parameters sheet carefully.
- RS485 A/B cable is for the A/B cable of the PTZ decoder.
- T+,T-,R+,R- are four-wire double duplex RS485 port.
T+ T-: output wire
R+ R-: input wire

Relay Specification

Model:	JRC-27F
---------------	----------------

Material of the touch	Silver	
Rating (Resistance Load)	Rated switch capacity	30VDC 2A, 125VAC 1A
	Maximum switch power	125VA 160W
	Maximum switch voltage	250VAC, 220VDC
	Maximum switch currenxy	1A
Insulation	Between touches with same polarity	1000VAC 1minute
	Between touches with different polarity	1000VAC 1minute
	Between touch and winding	1000VAC 1minute
Surge voltage	Between touches with same polarity	1500V (10×160us)
Length of open time	3ms max	
Length of close time	3ms max	
Longevity	Mechanical	50×106 times (3Hz)
	Electrical	200×103 times (0.5Hz)
Temperature	-40℃ ~+70℃	

3.9 RS485

When the DVR receives a camera control command, it transmits that command up the coaxial cable to the PTZ device. RS485 is a single-direction protocol; the PTZ device can't return any data to the unit. To enable the operation, connect the PTZ device to the RS485 (A,B) input on the DVR.

Since RS485 is disabled by default for each camera, you must enable the PTZ settings first.

This series DVRs support multiple protocols such as Pelco-D, Pelco-P.

To connect PTZ devices to the DVR:

1. Connect RS485 A,B on the DVR rear panel.
2. Connect the other end of the cable to the proper pins in the connector on the camera.
3. Please follow the instructions to configure a camera to enable each PTZ device on the DVR.

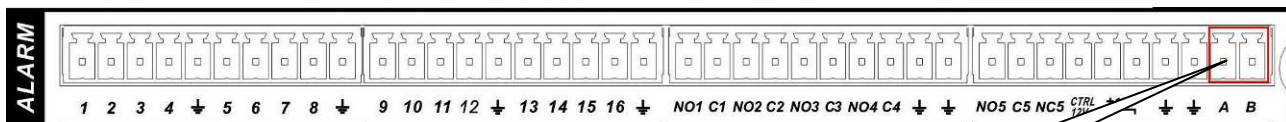

Figure 3-8

3.10 Other Interfaces

There are still other interfaces on the DVR, such as USB ports. You can refer to Figure 3-9 for more information.

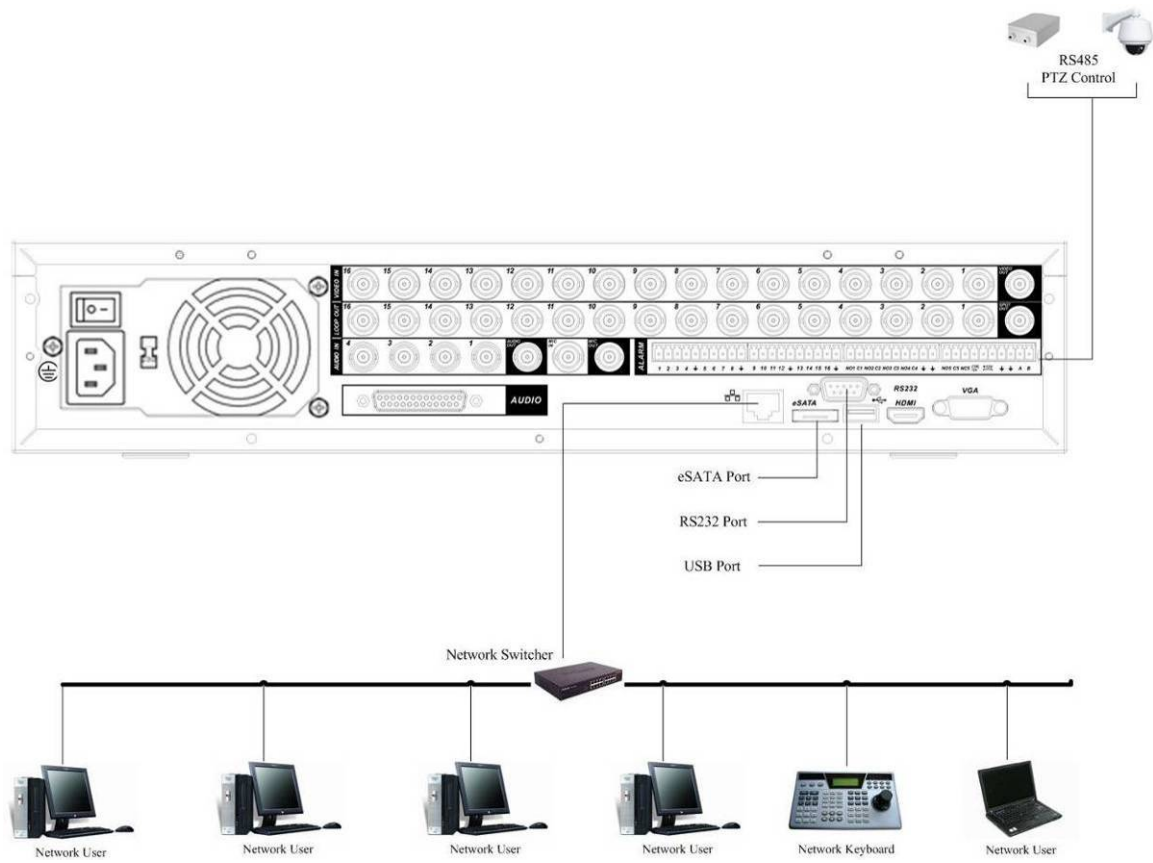

Figure 3-9

4 Overview of Navigation and Controls

Before operation, please make sure:

- You have properly installed HDD and all the cable connections.
- The provided input power and the device power are matched.
- The external power shall be DC 12V.
- Always use the stable current, if necessary UPS is a best alternative measure.

4.1 Login, Logout & Main Menu

4.1.1 Login

After system booted up, system pops up the startup wizard.

Click the Cancel button; you can go to the system login interface.

Click the Next Step button; you can go to the startup wizard interface. Here you can set the system basic information. See Figure 4-1.

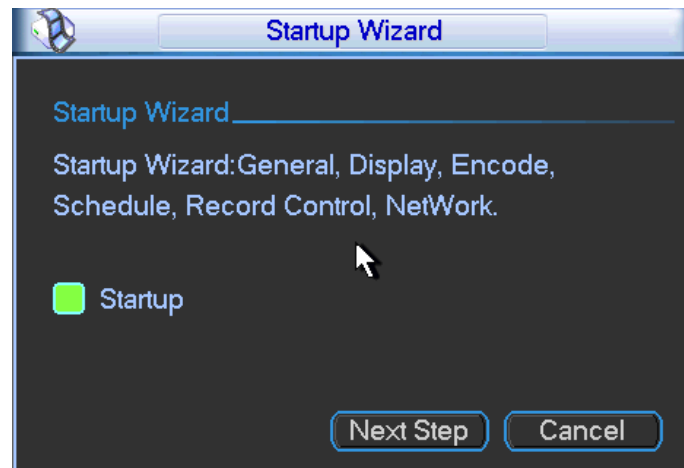

Figure 4-1

The system login interface is shown as in Figure 4-2.

System consists of four accounts:

- **Username:** admin. **Password:** admin. (administrator, local and network)
- **Username:** 888888. **Password:** 888888. (administrator, local only)
- **Username:** 666666. **Passwords:** 666666(Lower authority user who can only monitor, playback, backup and etc.)
- **Username:** default. **Password:** default(hidden user)

You can use USB mouse, front panel, remote control or keyboard to input. About input

method: Click **123** to switch between numeral, English character (small/capitalized) and denotation.

Note:

For security reason, please modify password after you first login.

Within 30 minutes, three times login failure will result in system alarm and five times login failure will result in account lock!



Figure 4-2

4.1.2 Main Menu

After you logged in, the system main menu is shown as below. See Figure 4-3.

There are total six icons: search, information, setting, backup, advanced and shutdown.

You can move the cursor to highlight the icon, and then double click mouse to enter the sub-menu.

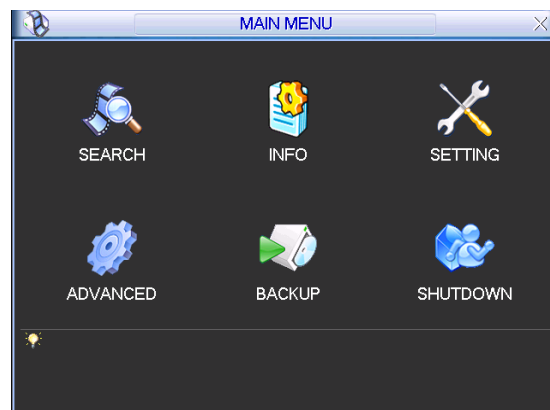

Figure 4-3

4.1.3 Logout

There are two ways for you to log out.

One is from menu option:

In the main menu, click shutdown button, you can see an interface is shown as below. See Figure 4-4.

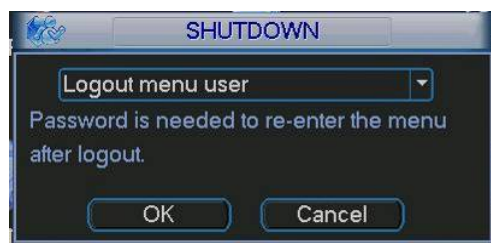

Figure 4-4

There are several options for you. See Figure 4-5.

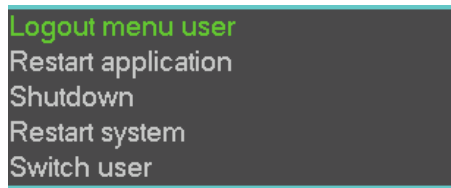

Figure 4-5

The other ways is to press power button on the front panel for at least 3 seconds, system will stop all operations. Then you can click the power button in the rear panel to turn off the DVR.

4.1.4 Auto Resume after Power Failure

The system can automatically backup video and resume previous working status after power failure.

4.1.5 Replace Button Battery

Please make sure to use the same battery model if possible.

We recommend replace battery regularly (such as one-year) to guarantee system time accuracy.

Note:

Before replacement, please save the system setup, otherwise, you may lose the data completely!

4.2 Manual Record

4.2.1 Live Viewing

After you logged in, the system is in live viewing mode. You can see system date, time and channel name. If you want to change system date and time, you can refer to general settings (Main Menu->Setting->General). If you want to modify the channel name, please refer to the display settings (Main Menu->Setting->Display)

1		Recording status	3		Video loss
2		Motion detection	4		Camera lock

Preview Zoom Function

Move your mouse to the left top corner of the preview interface; you can see the preview zoom button. See Figure 4-6. Left click the icon; you can see a hook icon. Now you have enabled the preview zoom function. You can drag the mouse to zoom in the image.



Figure 4-6

4.2.2 Manual record

Note:

You need to have proper rights to implement the following operations. Please make sure the HDD has been properly installed.

4.2.2.1 Manual record menu

There are two ways for you to go to manual record menu.

- Right click mouse or in the main menu, Advanced->Manual Record.
- In live viewing mode, click record button in the front panel or record button in the remote control.

Manual record menu is shown as in Figure 4-7.

4.2.2.2 Basic operation

There are three statuses: schedule/manual/stop. Please highlight icon “○” to select corresponding channel.

- Manual: The highest priority. After manual setup, all selected channels will begin ordinary recording.
- Schedule: Channel records as you have set in recording setup (Main Menu->Setting->Schedule)
- Stop: All channels stop recording.

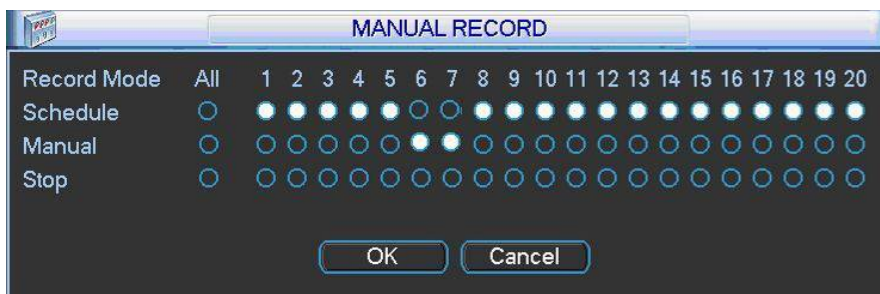

Figure 4-7

4.2.2.3 Enable/disable record

Please check current channel status: “○” means it is not in recording status, “●” means it is in recording status.

You can use mouse or direction key to highlight channel number. See Figure 4-8.

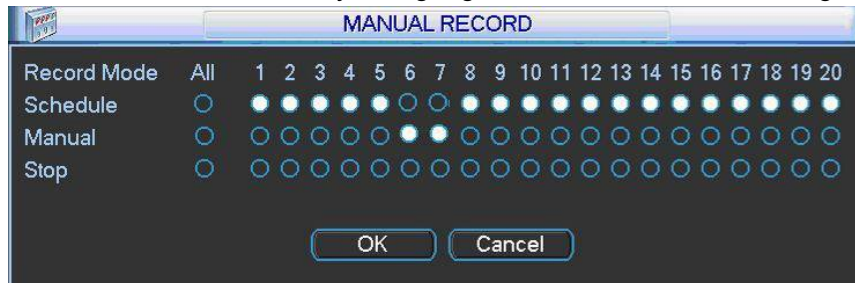

Figure 4-8

4.2.2.4 Enable all channel recording

Highlight ○ below All, you can enable all channel recording.

- All channel schedule record

Please highlight “ALL” after “Schedule”. See Figure 4-9.

When system is in schedule recording, all channels will record as you have previously set (Main menu->Setting->Schedule).

The corresponding indication light in front panel will turn on.

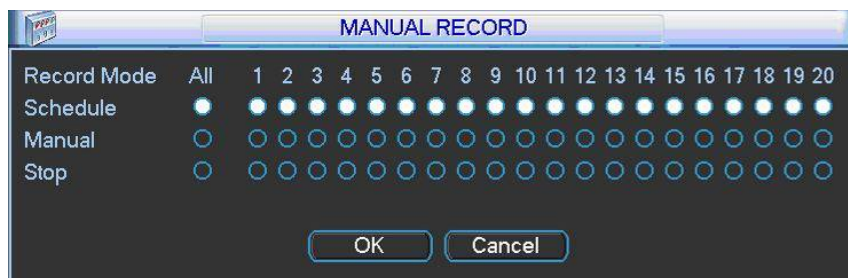

Figure 4-9

- All channel manual record

Please highlight “ALL” after “Manual.” See Figure 4-10.

When system is in manual recording, all scheduled set up you have set in will be null ((Main menu->Setting->Schedule)).

You can see indication light in front panel turns on, system begins manual record now.

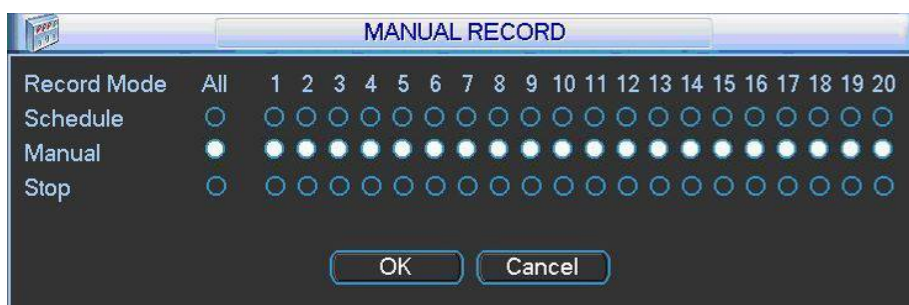

Figure 4-10

4.2.2.5 Stop all channel recording

Please highlight “ALL” after “Stop”. See Figure 4-11.

System stops all channel recording no matter what mode you have set in the menu (Main menu->Setting->Schedule)

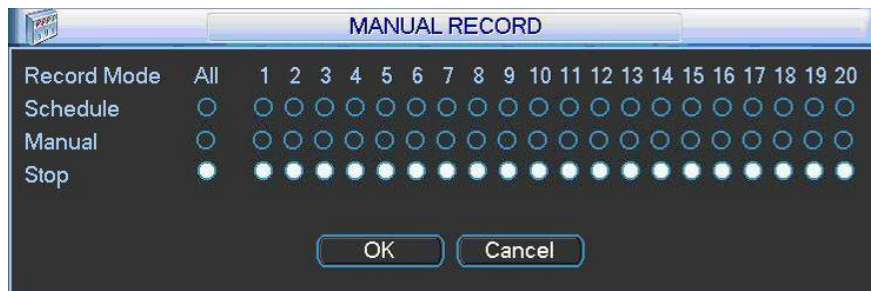

Figure 4-11

4.3 Search & Playback

Click search button in the main menu, search interface is shown as below. See Figure 4-12.

Usually there are three file types:

- R: Regular recording file.
- A: External alarm recording file.
- M: Motion detection recording file

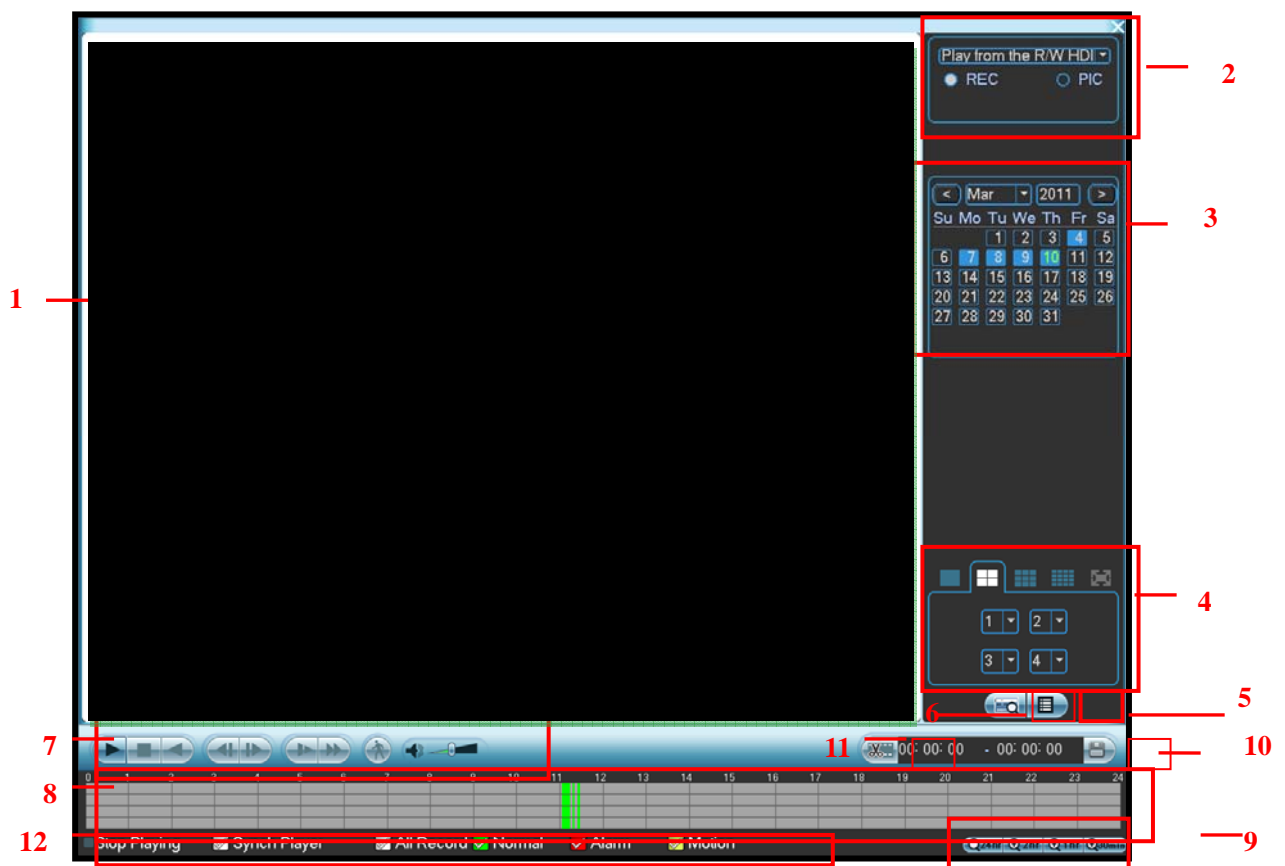
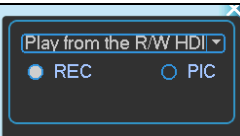

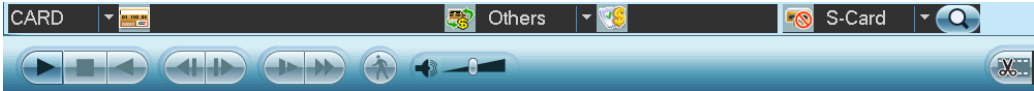







Figure 4-12

Please refer to the following sheet for more information.

SN	Name	Function	
1	Display window	<ul style="list-style-type: none"> ● Here is to display the searched picture or file. ● Support 1/4/9/16-window playback. 	
2	Search type	<ul style="list-style-type: none"> ● Here you can select to search the picture or the recorded file. ● When there is displayed picture on the left pane, you can set the corresponding setup 	
3	Calendar	<ul style="list-style-type: none"> ● The blue highlighted date means there is picture or file. Otherwise, there is no picture or file. ● In any play mode, click the date you want to see, you can see the corresponding record file trace in the time bar. 	
4	Playback mode and channel selection pane.	<ul style="list-style-type: none"> ● Playback mode: 1/4/9/16. (It may vary due to different series.) ◇ In 1-window playback mode: you can select 1-16 channels. ◇ In 4-window playback mode: you can select 4 channels according to your requirement. ◇ In 9-window playback mode, you can switch between 1-9 and 10-16 channels. ◇ In 16-window playback mode, you can switch between 1-16 and 17-32 channels. ● The time bar will change once you modify the playback mode or the channel option. 	
5	File list switch button	<ul style="list-style-type: none"> ● Double click it, you can view the picture/record file list of current day. ● The file list is to display the first channel of the record file. ● The system can display max 128 files in one time. Use the ▲/▼ or the mouse to view the file. Select one item, and then double click the mouse or click the ENTER button to playback. ● You can input the period in the following interface to begin accurate search. ● File type: R—regular record; A—external alarm record; M—Motion detect record. 	
6	Card number search	<p>The card number search interface is shown as below.</p> 	
7	Playback control pane.	▶ /	<p>Play/Pause</p> <p>There are three ways for you to begin playback.</p> <ul style="list-style-type: none"> ● The play button ● Double click the valid period of the time bar. ● Double click the item in the file list. <p>In slow play mode, click it to switch between play/pause.</p>
		■	Stop
		◀	Backward play

In normal play mode, left click the button, the file begins backward play.

		<p>Click it again to pause current play. In backward play mode, click ►/ to restore normal play.</p>
		<p>In playback mode, click it to play the next or the previous section. You can click continuously when you are watching the files from the same channel. In normal play mode, when you pause current play, you can click ◀ and ▶ to begin frame by frame playback. In frame by frame playback mode, click ►/ to restore normal playback.</p>
		<p>Slow play In playback mode, click it to realize various slow play modes such as slow play 1, slow play 2, and etc.</p>
		<p>Fast forward In playback mode, click to realize various fast play modes such as fast play 1, fast play 2 and etc.</p>
	<p>Note: The actual play speed has relationship with the software version.</p>	
		<p>Smart search</p>
		<p>The volume of the playback</p>
		<p>Click the snapshot button in the full-screen mode, the system can snapshot 1 picture per second.</p>
8	Time bar	<ul style="list-style-type: none"> ●It is to display the record type and its period in current search criteria. ●In 4-window playback mode, there are corresponding four time bars. In other playback mode, there is only one time bar. ●Use the mouse to click one point of the color zone in the time bar, system begins playback. ●The time bar is beginning with 0 o'clock when you are setting the configuration. The time bar zooms in the period of the current playback time when you are playing the file. ●The green color stands for the regular record file. The red color stands for the external alarm record file. The yellow stands for the motion detect record file.
9	Time bar unit	<ul style="list-style-type: none"> ●The option includes: 24H, 12H, 1H and 30M. The smaller the unit, the larger the zoom rate. You can accurately set the time in the time bar to playback the record. ●The time bar is beginning with 0 o'clock when you are setting the configuration. The time bar zooms in the period of the current playback time when you are playing the file.
10	Backup	<p>Select the file(s) you want to backup from the file list. System max supports files from four channels. Then click the backup button, now you can see the backup menu. Click the start button to begin the backup operation. Check the file again you can cancel current selection. System max supports to display 32 files from one channel.</p>
11	Clip	<ul style="list-style-type: none"> ●It is to edit the file. ●Please play the file you want to edit and then click this button when you want to edit. You can see the corresponding slide bar in the time bar of the corresponding

		channel. You can adjust the slide bar or input the accurate time to set the file end time. Click this button again and then save current contents in a new file. .
12	Record type	In any play mode, the time bar will change once you modify the search type.
13	Smart search	<ul style="list-style-type: none"> ● When system is playing, you can select a zone in the window to begin motion detect. Click the motion detect button to begin play. ● Current button is null once the motion detect play has begun. ● The system will take the whole play zone as the motion detect region by default. ● The motion detect play stopped once you switch the play file. ● Operations such as set time bar, click the play button, or any file list operation will stop current motion detect play.
Other Functions		
14	Other channel synchronization switch to play when playback	When playing the file, click the number button, system can switch to the same period of the corresponding channel to play.
15	Digital zoom	When the system is in full-screen playback mode, left click the mouse in the screen. Drag your mouse in the screen to select a section and then left click mouse to realize digital zoom. You can right click mouse to exit.

Note:

All the operations here (such as playback speed, channel, time and progress) have relationship with hardware version. Some series DVRs do not support some functions or playback speeds.

4.4 Schedule

After system booted up, it is in default 24-hour regular mode. You can set record type and time in schedule interface.

4.4.1 Schedule Menu

In the main menu, from setting to schedule, you can go to schedule menu. See Figure 4-13.

- Channel: Please select the channel number first. You can select “all” if you want to set for the whole channels.
- Week day: There are eight options: ranges from Saturday to Sunday and all.
- Pre-record: System can pre-record the video before the event occurs into the file. The value ranges from 1 to 30 seconds depending on the bit stream.
- Redundancy: System supports redundancy backup function. It allows you backup recorded file in two disks. You can highlight Redundancy button to activate this function. Please note, before enable this function, please set at least one HDD as redundant. (Main menu->Advanced->HDD Management) Please refer to chapter 4.4.1.2 for detailed information.
- Snapshot: You can enable this function to snapshot image when alarm occurs.

- Record types: There are four types: regular, motion detection (MD), Alarm, MD & alarm.

Please highlight icon  to select the corresponding function. After completing all the setups please click save button, system goes back to the previous menu.

At the bottom of the menu, there are color bars for your reference. Green color stands for regular recording, yellow color stands for motion detection and red color stands for alarm recording. The white means the MD and alarm record is valid. Once you have set to record when the MD and alarm occurs, system will not record neither motion detect occurs nor the alarm occurs.



Figure 4-13

4.4.1.1 Quick Setup

This function allows you to copy one channel setup to another. After setting in channel 1, you can click paste button and turn to channel 2 and then click copy button. You can finish setting for one channel and then click save button or you can finish all setup and then click save button to memorize all the settings.

4.4.1.2 Redundancy

Redundancy function allows you to memorize record file in several disks. When there is file damage occurred in one disk, there is a spare one in the other disk. You can use this function to maintain data reliability and safety.

In the main menu, from Setting to Schedule, you can highlight redundancy button to enable this function. See Figure 4-13.

In the main menu, from Advanced to HDD management, you can set one or more disk(s) as redundant. You can select from the dropdown list. See Figure 4-14. System auto overwrites old files once hard disk is full.

Please note only read/write disk or read-only disk can backup file and support file search function, so you need to set at least one read-write disk otherwise you can not record video.

Note

About redundancy setup:

- If current channel is not recording, current setup gets activated when the channel begin recording the next time.
- If current channel is recording now, current setup will get activated right away, the current file will be packet and form a file, then system begins recording as you have just set.

After all the setups please click save button, system goes back to the previous menu.

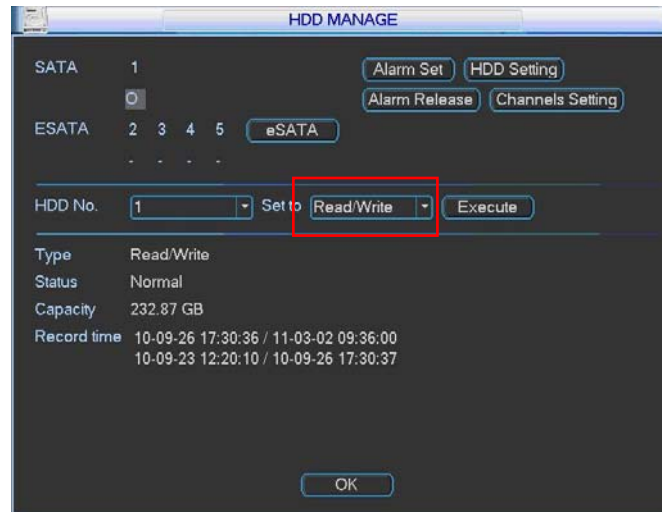

Figure 4-14

Playback or search in the redundant disk.

There are two ways for you to playback or search in the redundant disk.

- Set redundant disk(s) as read-only disk or read-write disk (Main menu->Advanced->HDD management). See Figure 4-14. System needs to reboot to get setup activated. Now you can search or playback file in redundant disk.
- Dismantle the disk and play it in another PC.

4.4.2 Snapshot

4.4.2.1 Schedule Snapshot

In Encode interface, click snapshot button to input snapshot mode, size, quality and frequency.

In General interface please input upload interval.

In Schedule interface, please enable snapshot function.

Please refer to the following figure for detailed information. See Figure 4-15.

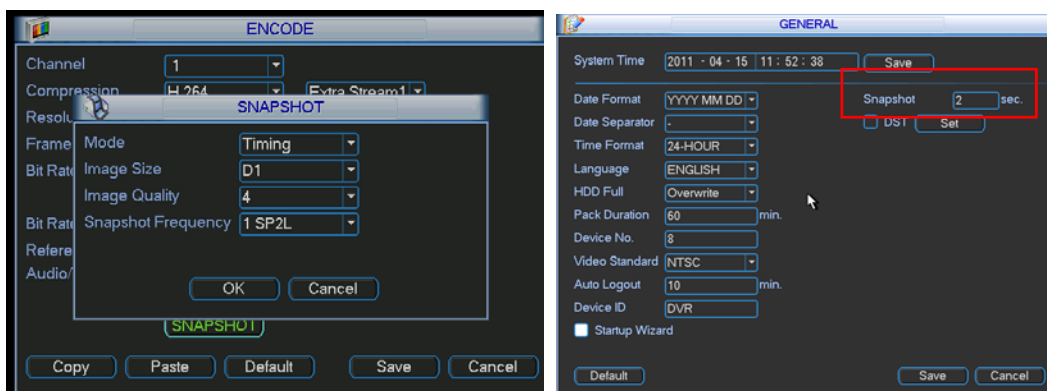

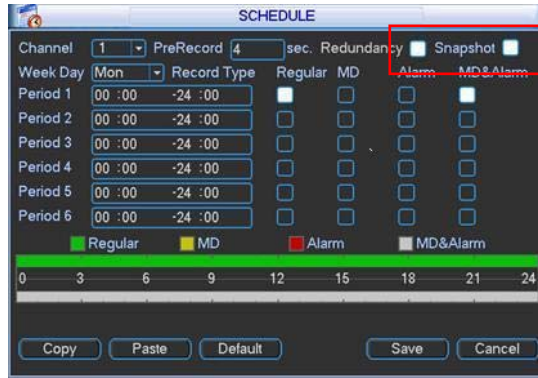

Figure 4-15

4.4.2.2 Activation Snapshot

Please follow the steps listed below to enable the activation snapshot function. After you enabled this function, system can snapshot when the corresponding alarm occurred.

- In Encode interface, click snapshot button to input snapshot mode, size, quality and frequency.
- In General interface please input upload interval.
- In Detect interface please enable snapshot function for specified channels. Or in alarm interface please enable snapshot function for specified channels.

Please refer to the following figure for detailed information. See Figure 4-16.

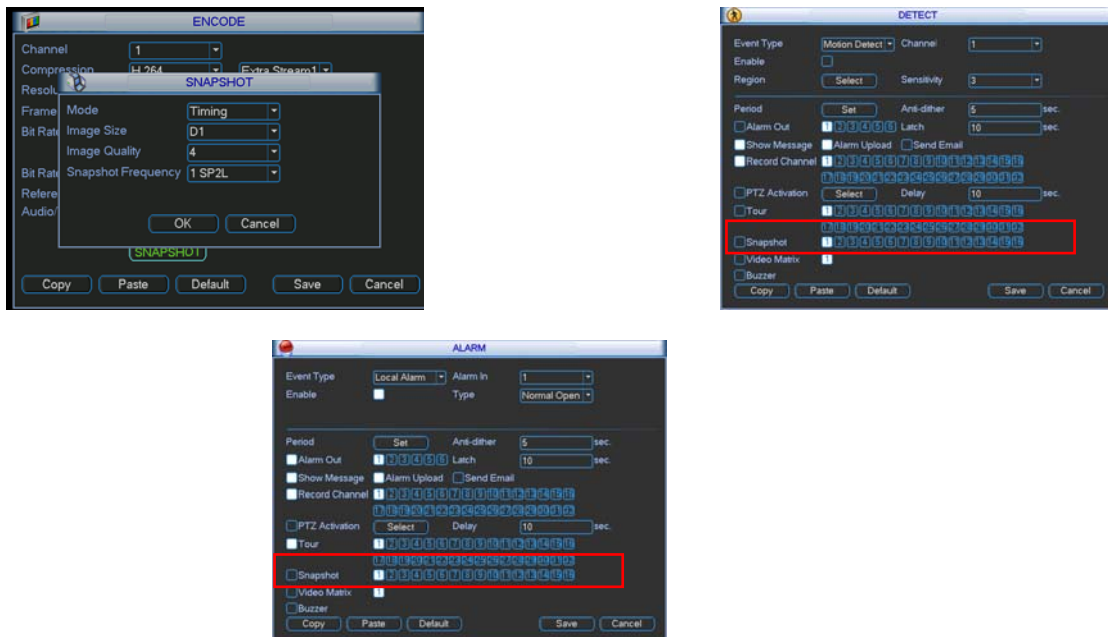

Figure 4-16

4.4.2.3 Priority

Please note the activation snapshot has the higher priority than schedule snapshot. If you have enabled these two types at the same time, system can activate the activation snapshot when alarm occurs, and otherwise system just operates the schedule snapshot.

4.4.3 Image FTP

In Network interface, you can set FTP server information. Please enable FTP function and then click save button. See Figure 4-17.

Please boot up corresponding FTP server.

Please enable schedule snapshot (Chapter 4.4.2.1) or activation snapshot (Chapter 4.4.2.2) first, now system can upload the image file to the FTP server.

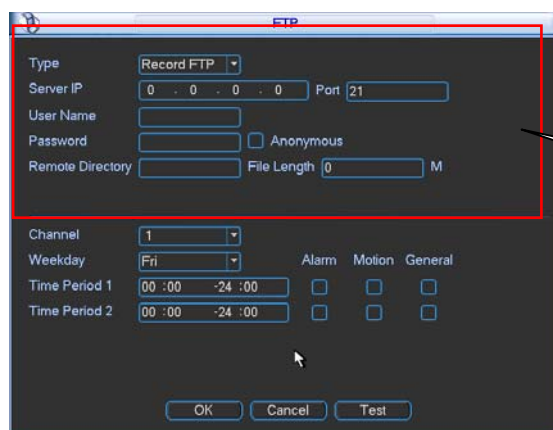

Please input the corresponding information here, if you just upload the image FTP.

Figure 4-17

4.4.4 Snapshot Disk (For special series only)

Set one disk as snapshot (Main menu->Advanced->HDD management) and then click execute button. See Figure 4-18. System needs to reboot to get current setup activated.

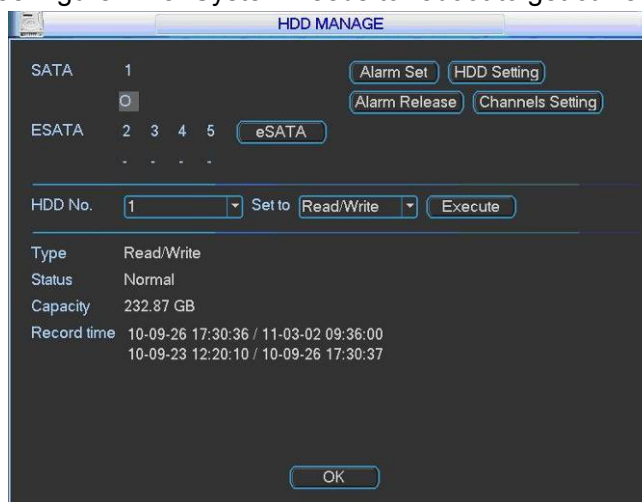

Figure 4-18

All scheduled snapshot files or activated snapshot files will be memorized in the snapshot disk.

You can search the corresponding images via Web. See Figure 4-19.

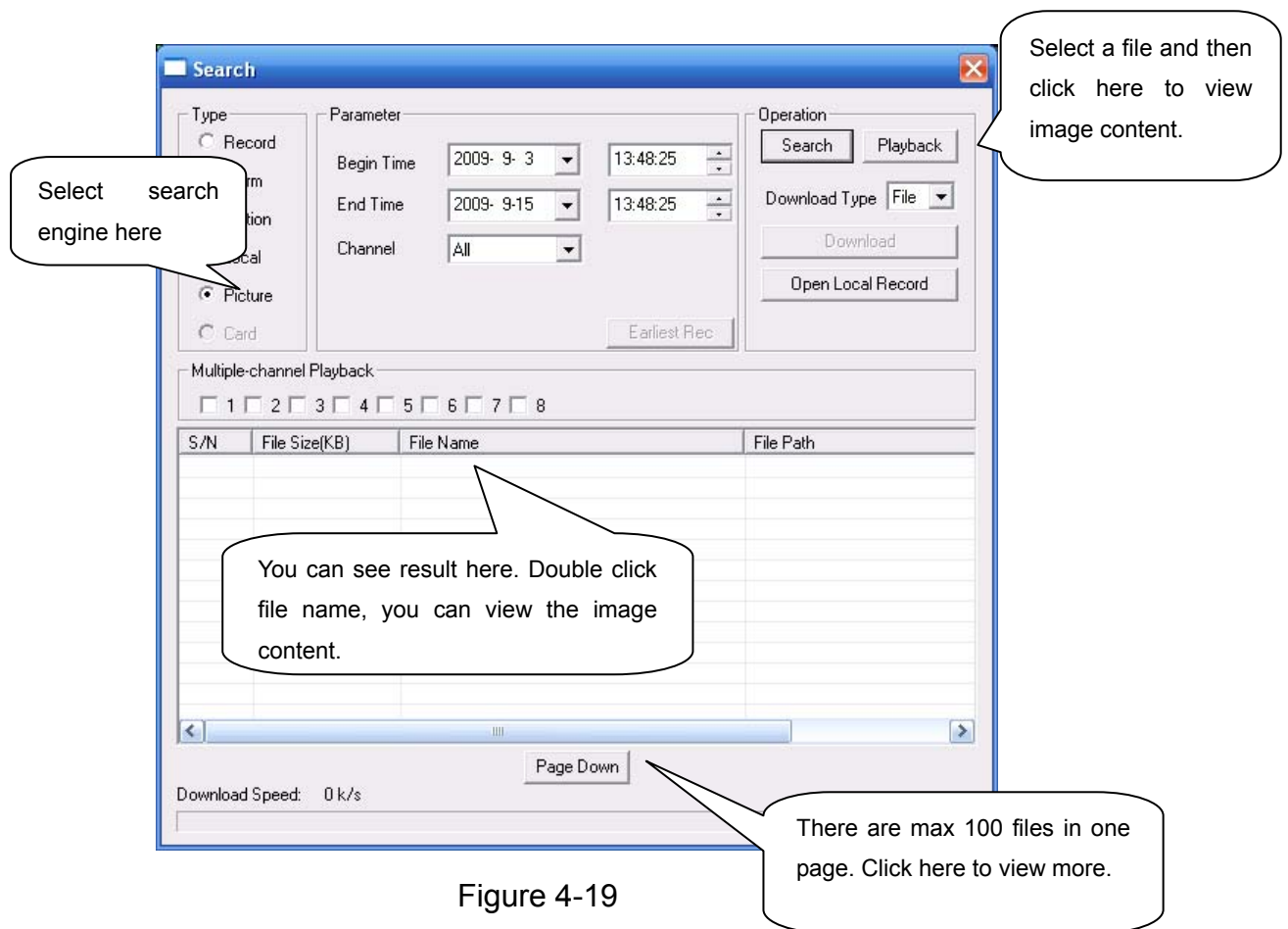

Figure 4-19

4.5 Detect

4.5.1 Go to Detect Menu

In the main menu, from Setting to Detect, you can see motion detect interface. See Figure 4-20. There are three detection types: motion detection, video loss, camera masking.

4.5.2 Motion Detect

Detection menu is shown as below. See Figure 4-20

- Event type: from the dropdown list you can select motion detection type.
- Channel: select the channel to activate recording function once alarm occurred. Please make sure you have set MD record in encode interface(Main Menu->Setting->Schedule) and schedule record in manual record interface(Main Menu->Advanced->Manual Record)
- Latch: when motion detection complete, system auto delays detecting for a specified time. The value ranges from 10-300(Unit: second)
- Region: Click select button, the interface is shown as in Figure 4-21. Here you can set motion detection zone. There are 396(PAL)/330(NTSC) small zones. The green zone is current cursor position. Grey zone is the motion detection zone. Black zone is the disarmed zone. You can click Fn button to switch between the arm mode and disarm mode. In arm mode, you can click the direction buttons to move the green

rectangle to set the motion detection zone. After you completed the setup, please click ENTER button to exit current setup. Do remember click save button to save current setup. If you click ESC button to exit the region setup interface system will not save your zone setup.

- Sensitivity: System supports 6 levels. The sixth level has the highest sensitivity.
- Show message: System can pop up a message to alarm you in the local host screen if you enabled this function.
- Alarm upload: System can upload the alarm signal to the network (including alarm centre) if you enabled current function.
- Send email: System can send out email to alert you when alarm occurs.
- PTZ activation: Here you can set PTZ movement when alarm occurs. Such as go to preset, tour & pattern when there is an alarm. Click “select” button, you can see an interface is shown as in Figure 4-22.
- Period: Click set button, you can see an interface is shown as in Figure 4-23. Here you can set for business day and non-business day. In Figure 4-23 click set button, you can see an interface is shown as in Figure 4-24. Here you can set your own setup for business day and non-business day.
- Anti-dither: Here you can set anti-dither time.
- Alarm output: when alarm occurred, system enables peripheral alarm devices.
- Tour: Here you can enable tour function when alarm occurs. System one-window tour. Please go to chapter 5.3.9 Display for tour interval setup.
- Snapshot: You can enable this function to snapshot image when alarm occurs.

Please highlight icon  to select the corresponding function. After all the setups please click save button, system goes back to the previous menu.

Note:

In motion detection mode, you can not use copy/paste to set channel setup since the video in each channel may not be the same.

In Figure 4-21, you can left click mouse and then drag it to set a region for motion detection. Click Fn to switch between arm/withdraw motion detection. After setting, click enter button to exit.

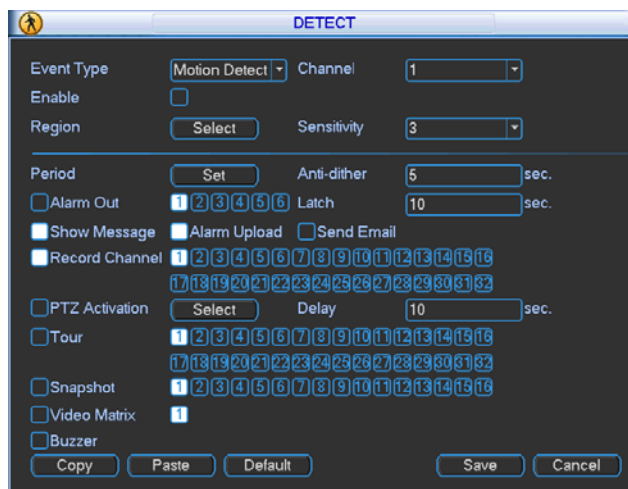

Figure 4-20

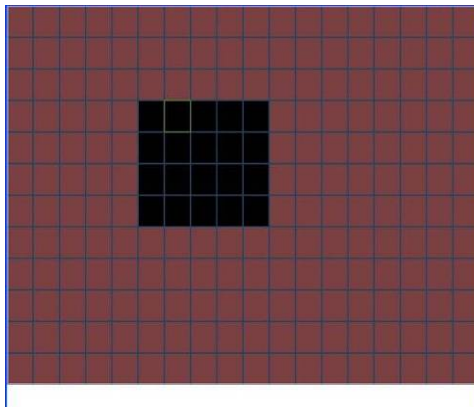

Figure 4-21

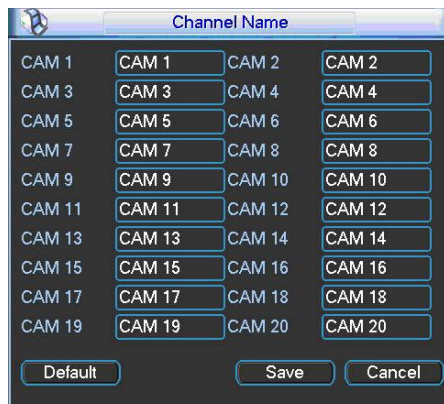

Figure 4-22

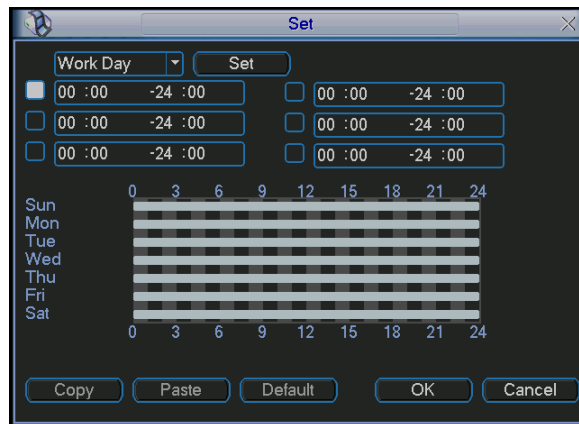

Figure 4-23

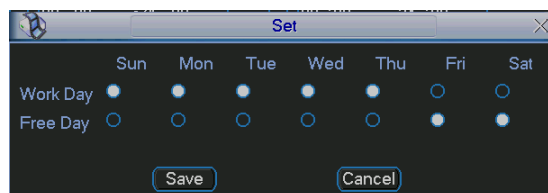

Figure 4-24

4.5.3 Video Loss

In Figure 4-20, select video loss from the type list. You can see the interface is shown as in Figure 4-25. This function allows you to be informed when video loss phenomenon occurred. You can enable alarm output channel and then enable show message function.

Tips:

You can enable preset activation operation when video loss occurs. Please refer to chapter 4.5.2 motion detection for detailed information.

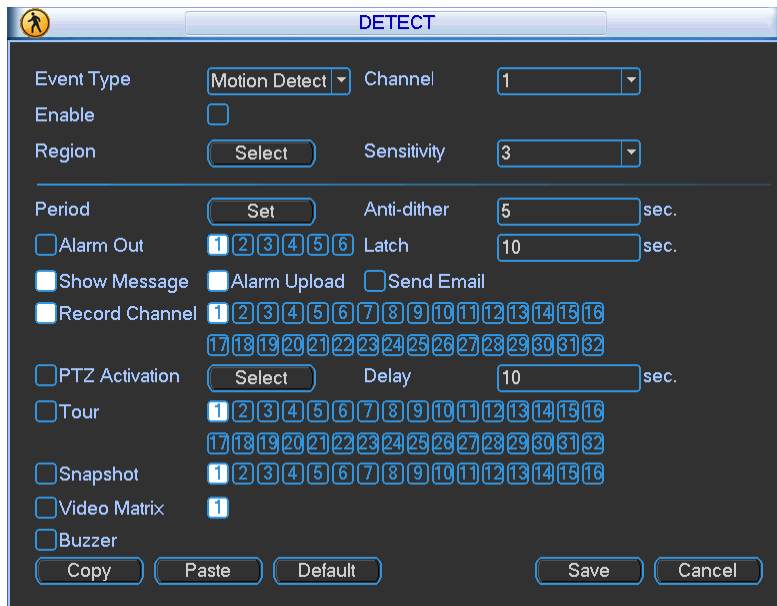

Figure 4-25

4.5.4 Camera Masking

When someone viciously masks the lens, or the output video is in one-color due to the environments light change, the system can alert you to guarantee video continuity. Camera masking interface is shown as in Figure 4-26.

Tips:

You can enable preset/tour/pattern activation operation when video loss occurs. Please refer to chapter 4.5.2 motion detection for detailed information.

Note:

In Detect interface, copy/paste function is only valid for the same type, which means you can not copy a channel setup in video loss mode to camera masking mode.

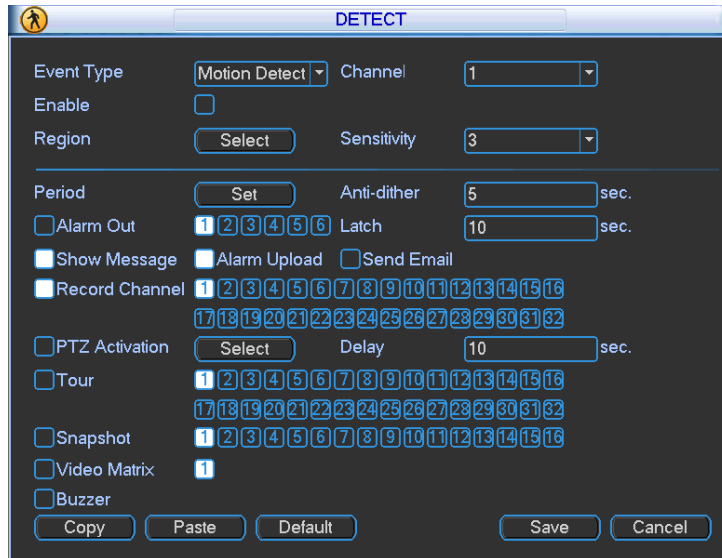

Figure 4-26

4.6 Alarm Setup and Alarm Activation

Before operation, please make sure you have properly connected alarm devices such as buzzer.

4.6.1 Go to alarm setup interface

In the main menu, from Setting to Alarm, you can see alarm setup interface. See Figure 4-27.

4.6.2 Alarm setup

Alarm interface is shown as below. See Figure 4-27.

- Alarm in: Here is for you to select channel number.
- Event type: There are two types. One is local input and the other is network input.
- Type: normal open or normal close.
- PTZ activation: Here you can set PTZ movement when alarm occurs. Such as go to preset, tour & pattern when there is an alarm. Click "select" button, you can see an interface is shown as in Figure 4-28.
- Period: Click set button, you can see an interface is shown as in Figure 4-29. Here you can set for business day and non-business day. In Figure 4-29, click set button, you can see an interface is shown as in Figure 4-30. Here you can set your own setup for business day and non-business day.
- Anti-dither: Here you can set anti-dither time.
- Show message: System can pop up a message to alarm you in the local host screen if you enabled this function.
- Alarm upload: System can upload the alarm signal to the network (including alarm centre) if you enabled current function.
- Send email: System can send out email to alert you when alarm occurs.
- Record channel: you can select proper channel to record alarm video (Multiple choices). At the same time you need to set alarm record in schedule interface (Main Menu->Setting->Schedule) and select schedule record in manual record interface (Main Menu->Advance->Manual Record).

- Latch: Here is for you to set proper delay duration. Value ranges from 10 to 300 seconds. System automatically delays specified seconds in turning off alarm and activated output after external alarm cancelled.
- Tour: Here you can enable tour function when alarm occurs. System supports one-window tour. Please go to chapter 5.3.9 Display for tour interval setup.
- Buzzer: Highlight the icon to enable this function. The buzzer beeps when alarm occurs.

For snapshot operation, please refer to chapter 4.4.2.

Please highlight icon  to select the corresponding function. After setting all the setups please click save button, system goes back to the previous menu.

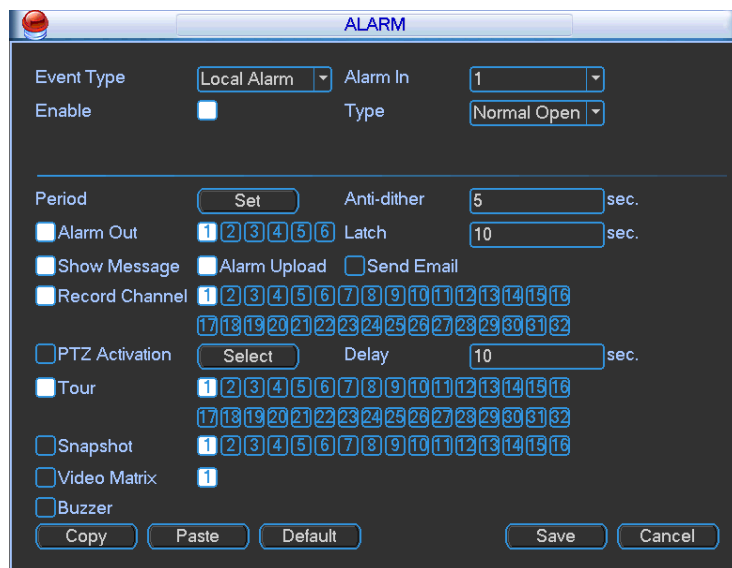

Figure 4-27

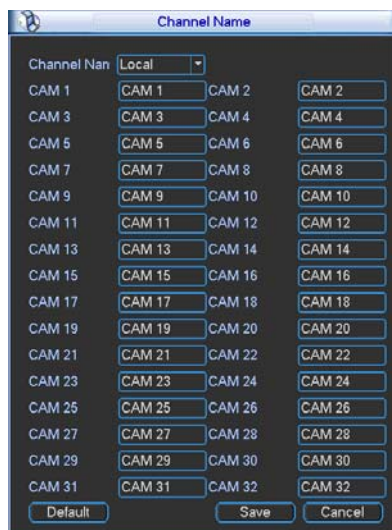

Figure 4-28

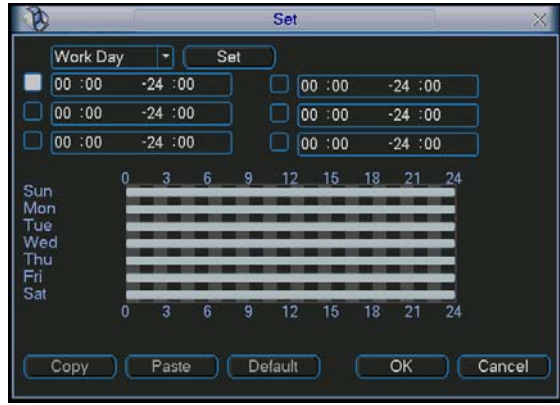

Figure 4-29

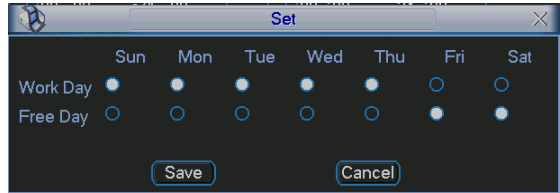

Figure 4-30

4.7 Backup

DVR support USB device backup and network download. Here we introduce USB backup. You can refer to Chapter 7 Web Client Operation for network download backup operation.

4.7.1 Detect Device

Click backup button, you can see an interface is shown as in Figure 4-31. Here is for you to view devices information.

You can view backup device name and its total space and free space. The device includes USB burner, flash disk, SD card, and portable HDD.

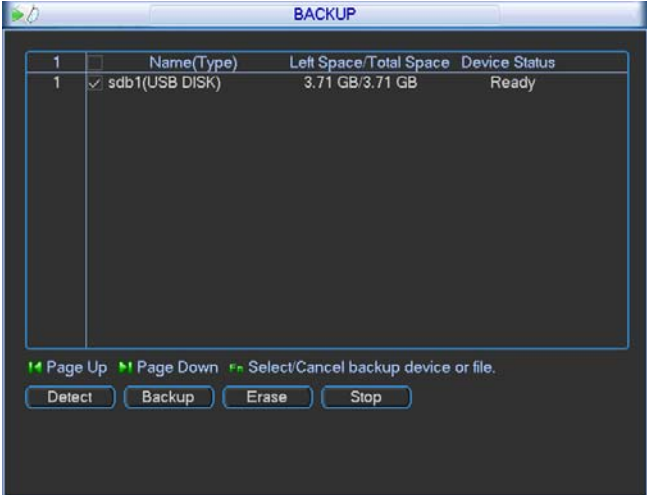

Figure 4-31

4.7.1 Backup

Select backup device and then set channel, file start time and end time.

Click add button, system begins search. All matched files are listed below. System automatically calculates the capacity needed and remained. See Figure 4-32.

system only backup files with a ✓ before channel name. You can use Fn or cancel button to delete ✓ after file serial number.

Click backup button, you can backup selected files. There is a process bar for you reference.

When the system completes backup, you can see a dialogue box prompting successful backup.

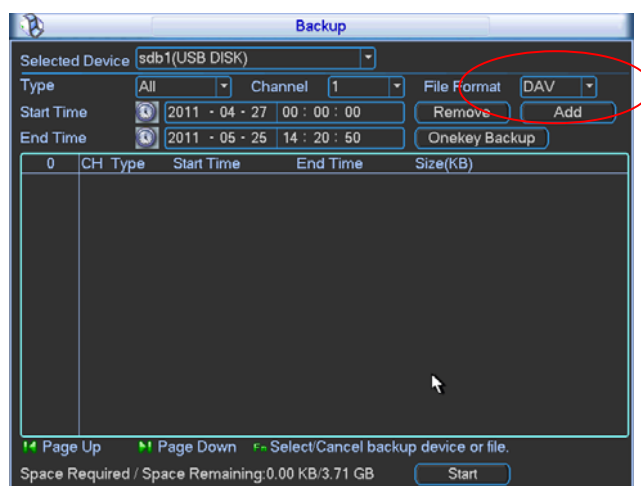

Figure 4-32

Click backup button, system begins burning. At the same time, the backup button becomes stop button. You can view the remaining time and process bar at the left bottom.

- File format: Click the file format; you can see there are two options: DAV/ASF.
- Picture backup: Please set the corresponding time, channel and then select the type as PIC from the dropdown list. See
- Figure 4-33. Please click the Add button and then select the pictures. Click the Start button; you can copy the specified pictures to the selected portable devices.

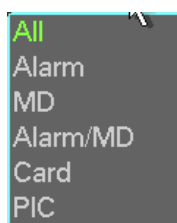

Figure 4-33

- One key backup: It includes three steps: the search, select all, start the backup. You can skip the above three steps and then copy all the searched files directly. The file name format usually is: SN_CH+channel number+time Y+M+D+H+M+S. In the

file name, the YDM format is the same as you set in general interface. (Main Menu ->Setting ->General).File extension name is .dav.

Tips:

During backup process, you can click ESC to exit current interface for other operation. The system will not terminate backup process.

Note:

When you click stop button during the burning process, the stop function becomes activated immediately. For example, if there are ten files, when you click stop system just backup five files, system only save the previous 5 files in the device (But you can view ten file names).

4.8 PTZ Control and Color Setup

Note: All the operations here are based on PELCOD protocol. For other protocols, there might be a little difference.

4.8.1 Cable Connection

Please follow the procedures below to go on cable connection

- Connect the dome RS485 port to DVR 485 port.
- Connect dome video output cable to DVR video input port.
- Connect power adapter to the dome.

4.8.2 PTZ Setup

Note: The camera video should be in the current screen. Before setup, please check the following connections are right:

- PTZ and decoder connection is right. Decoder address setup is right.
- Decoder A (B) line connects with DVR A (B) line.

Boot up the DVR, input user name and password.

In the main menu, click setting, and then click Pan/Tilt Control button. The interface is shown as in Figure 4-34. Here you can set the following items:

- Channel: select the current camera channel.
- Protocol: select corresponding PTZ protocol(such as PELCOD)
- Address: default address is 1.
- Baud rate: select corresponding baud rate. Default value is 9600.
- Data bits: select corresponding data bits. Default value is 8.
- Stop bits: select corresponding stop bits. Default value is 1.
- Parity: there are three options: odd/even/none. Default setup is none.



Figure 4-34

After completing all the setting please click save button.

In one window display mode, right click mouse (click “Fn” Button in the front panel or click “Fn” key in the remote control). The interface is shown as in Figure 4-35.

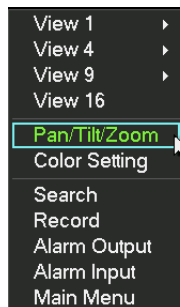

Figure 4-35

Click Pan/Tilt/Zoom, the interface is shown as below. See Figure 4-36.

Here you can set the following items:

- Step: value ranges fro 1 to 8.
- Zoom
- Focus
- Iris

Please click icon  and  to adjust zoom, focus and iris.



Figure 4-36

In Figure 4-36, please click direction arrows (See Figure 4-37) to adjust PTZ position. There are total 8 direction arrows.



Figure 4-37

4.8.3 3D Intelligent Positioning Key

In the middle of the eight direction arrows, there is a 3D intelligent positioning key. See Figure 4-38. Please make sure your protocol supports this function and you need to use mouse to control.

Click this key, system goes back to the single screen mode. Drag the mouse in the screen to adjust section size. The dragged zone supports 4X to 16X speeds. It can realize PTZ automatically. The smaller zone you dragged, the higher the speed.



Figure 4-38

Here is a sheet for you reference.

Name	Function key	function	Shortcut key	Function key	function	Shortcut Key
Zoom		Near			Far	
Focus		Near			Far	
Iris		close			Open	

4.9 Preset/ Patrol/Pattern/Scan

In Figure 4-36, please click the “set” button. The interface is shown as below. See Figure 4-39.

Here you can set the following items:

- Preset
- Tour
- Pattern
- Border

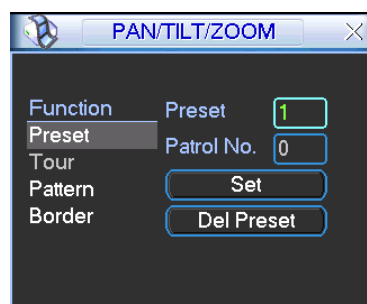

Figure 4-39

In Figure 4-36, click page switch button, the interface is shown as in Figure 4-40.

Here you can activate the following functions:

- Preset
- Tour
- Pattern
- Auto scan
- Auto pan
- Flip
- Reset
- Page switch

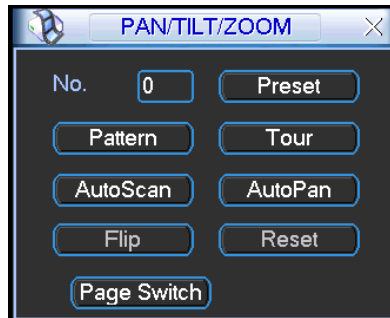

Figure 4-40

Note:

- Preset, tour and pattern all need the value to be the control parameter. You can define it as you require.
- You need to refer to your speed dome user's manual for Aux definition. In some cases, it can be used for special process.
- The following setups are usually operated in the Figure 4-36, Figure 4-39 and Figure 4-40.

4.9.1Preset Setup

In Figure 4-36, use eight direction arrows to adjust camera to the proper position.

In Figure 4-39, click preset button and input preset number. The interface is shown as in Figure 4-41.

Now you can add this preset to one tour.



Figure 4-41

4.9.2 Activate Preset

In Figure 4-40, please input preset number in the No. blank, and click preset button.

4.9.3 Patrol setup (Tour Setup)

In Figure 4-38, click patrol button. The interface is shown as in Figure 4-42. Input preset number and add this preset to a patrol (tour). For each patrol (tour), you can input max 80 presets.



Figure 4-42

4.9.4 Activate Patrol (tour)

In Figure 4-39, input patrol (tour) number in the No. blank and click patrol button

4.9.5 Pattern Setup

In Figure 4-39, click pattern button and then click "begin" button. The interface is shown as in Figure 4-43. Then you can go to Figure 4-36 X to modify zoom, focus, and iris. Go back to Figure 4-43 and click "end" button. You can memorize all these operations as pattern 1.



Figure 4-43

4.9.6 Activate Pattern Function

In Figure 4-39, input mode value in the No. blank, and click pattern button.

4.9.7 Auto Scan Setup

In Figure 4-38, click border button. The interface is shown as in Figure 4-43. Please go to Figure 4-35, use direction arrows to select camera left limit. Then please go to Figure 4-43 and click left limit button. Repeat the above procedures to set right limit.



Figure 4-44

4.9.8 Activate Auto Scan

In Figure 4-40, click “Auto Scan” button, the system begins auto scan. Correspondingly, the auto scan button becomes Stop button. Click stop button to terminate scan operation.

4.10 Flip

In Figure 4-40, click page switch button, you can see an interface is shown as below. See Figure 4-45. Here you can set auxiliary function. The aux value has relation ship with the Aux button of the decoder.

Click page switch button again, system goes back to Figure 4-36.

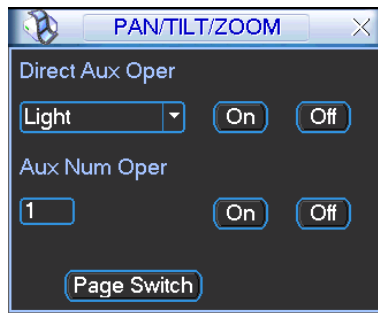
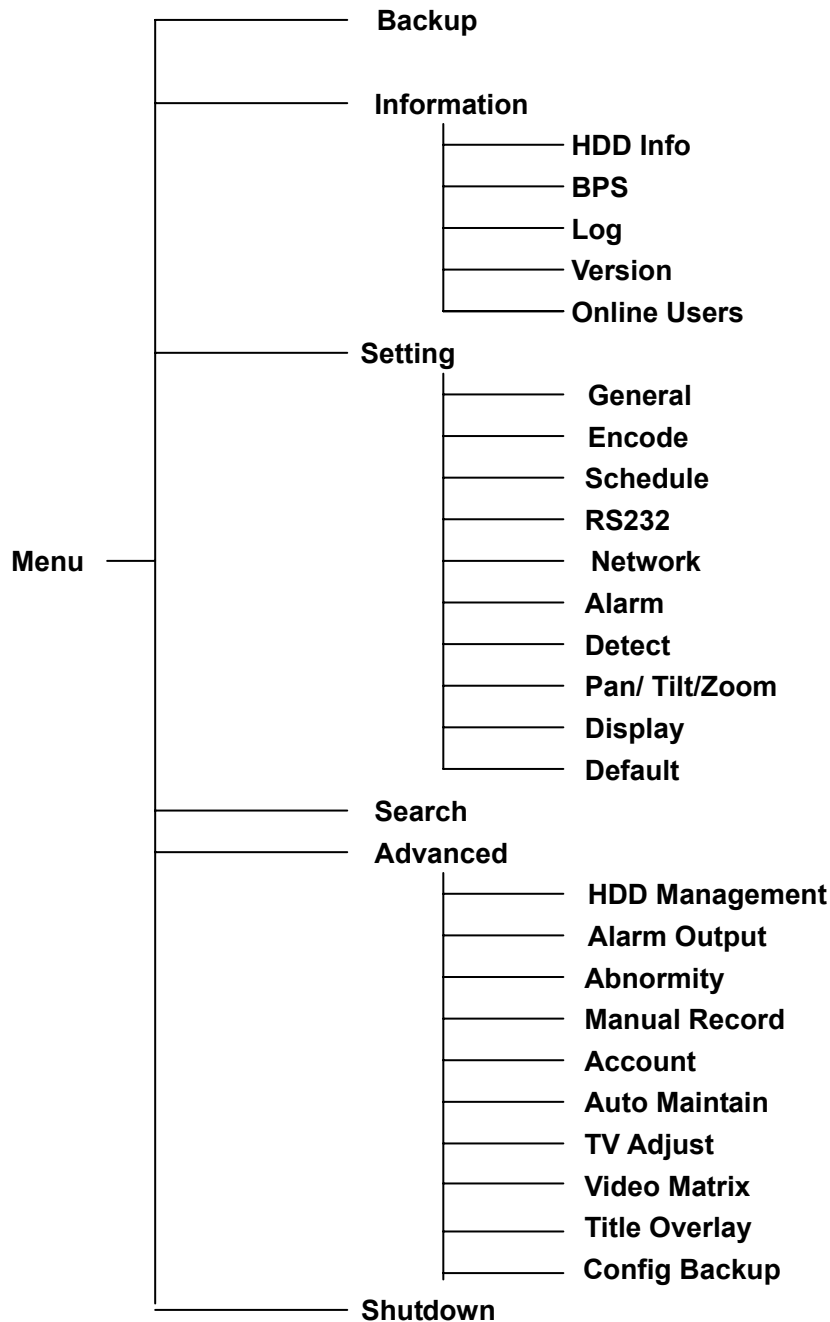

Figure 4-45

5 Understanding of Menu Operations and Controls

5.1 Menu Tree

This series DVR menu tree is shown as below.



5.2 Main Menu

After you logged in, the system main menu is shown as below. See Figure 5-1. There are total six icons: search, Information, setting, backup, advanced and shutdown. Move the cursor to highlight the icon, then double click mouse to enter the sub-menu.

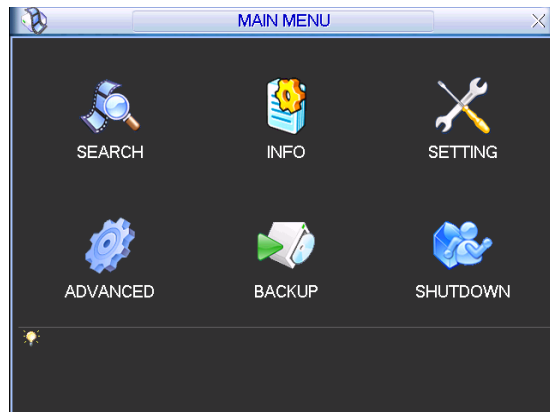

Figure 5-1

5.3 Setting

In main menu, highlight setting icon and double click mouse. System setting interface is shown as below. See Figure 5-2.

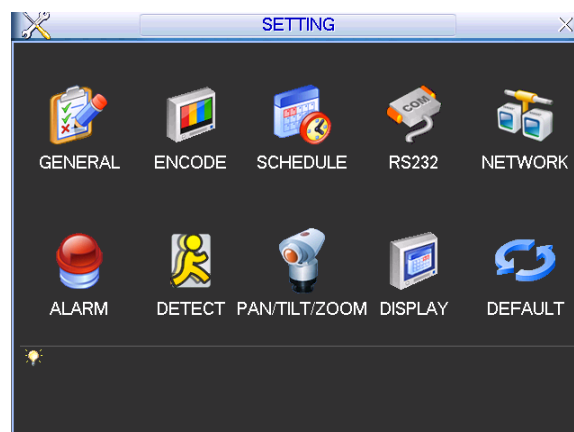

Figure 5-2

5.3.1 General

General setting includes the following items. See Figure 5-3.

- System time: Here is for you to set system time
- Date format: There are three types: YYYY-MM-DD: MM-DD-YYYY or DD-MM-YYYY.
- Date separator: There are three denotations to separate date: dot, beeline and solidus.
- DST: Here you can set DST time and date. Please enable DST function and then click set button. You can see an interface is shown as in Figure 5-4. Here you can set start time and end time by setting corresponding week setup. In Figure 5-4, enable date button, you can see an interface is shown as in Figure 5-5. Here you can set start time and end time by setting corresponding date setup.
- Time format: There are two types: 24-hour mode or 12-hour mode.

- Language: System supports various languages: Chinese (simplified), Chinese (Traditional), English, Italian, Japanese, French, Spanish (All languages listed here are optional. Slight difference maybe found in various series.)
- HDD full: Here is for you to select working mode when hard disk is full. There are two options: stop recording or rewrite. If current working HDD is overwritten or the current HDD is full while the next HDD is no empty, then system stops recording, If the current HDD is full and then next HDD is not empty, then system overwrites the previous files.
- Pack duration: Here is for you to specify record duration. The value ranges from 1 to 120 minutes. Default value is 60 minutes.
- DVR No: When you are using one remote control (not included in the accessory bag) to control several DVRs, you can give a name to each DVR for your management.
- Video standard: There are two formats: NTSC and PAL.
- Auto logout: Here is for you to set auto logout interval once login user remains inactive for a specified time. Value ranges from 0 to 60 minutes.
- Startup wizard: Once you check the box here, system will go to the startup wizard directly when the system restarts the next time. Otherwise, it will go to the login interface.
- Device ID: Please input a corresponding device name here.

Note:

Since system time is very important, do not modify time casually unless there is a must!

Before your time modification, please stop record operation first!

After completing all the setups please click save button, system goes back to the previous menu.

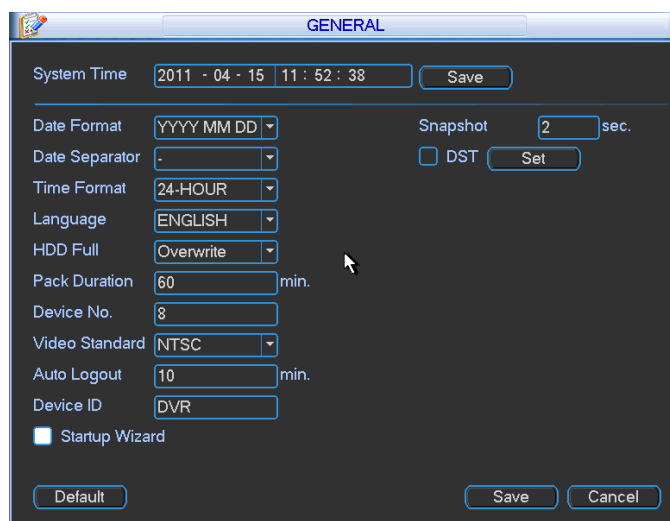

Figure 5-3

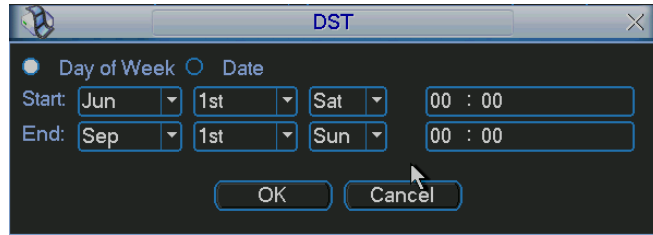

Figure 5-4

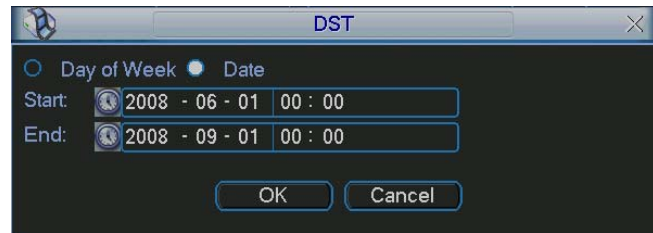

Figure 5-5

5.3.2 Encode

Encode setting includes the following items. See Figure 5-6.

Please note some series do not support extra stream.

- Channel: Select the channel you want.
- Type: Please select from the dropdown list. There are three options: regular/motion detect/alarm. You can set the various encode parameters for different record types.
- Compression: System supports H.264.
- Resolution: System supports various resolutions, you can select from the dropdown list. The main stream supports D1/HD1/2CIF/CIF/QCIF and the 1-16 channel extra stream supports CIF/QCIF. Please note the option may vary due to different series.
- Frame rate: It ranges from 1f/s to 25f/s in NTSC mode and 1f/s to 30f/s in PAL mode.
- Bit rate type: System supports two types: CBR and VBR. In VBR mode, you can set video quality.
- Quality: There are six levels ranging from 1 to 6. The sixth level has the highest image quality.
- Video/audio: You can enable or disable the video/audio.
- Overlay: Click overlay button, you can see an interface is shown in Figure 5-7.
- ✧ Cover area (Privacy mask): Here is for you to set privacy mask section. You can drag you mouse to set proper section size. In one channel video, system max supports 4 zones in one channel.
- ✧ Preview/monitor: privacy mask has two types. Preview and Monitor. Preview means the privacy mask zone can not be viewed by user when system is in preview status. Monitor means the privacy mask zone can not be view by the user when system is in monitor status.
- ✧ Time display: You can select system displays time or not when you playback. Please click set button and then drag the title to the corresponding position in the screen.

- ✧ Channel display: You can select system displays channel number or not when you playback. Please click set button and then drag the title to the corresponding position in the screen.

Please highlight icon  to select the corresponding function.



Figure 5-6

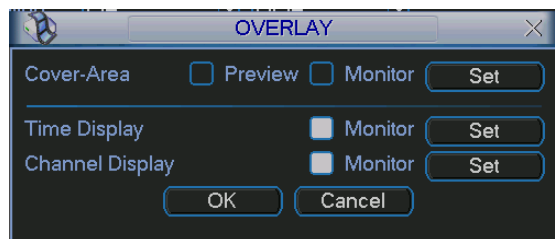

Figure 5-7

5.3.3 Schedule

Please refer to chapter 4.4 schedule.

5.3.4 RS232

RS232 interface is shown as below. There are five items. See Figure 5-8.

- Function: There are various devices for you to select. Console is for you to use the COM or mini-end software to upgrade or debug the program. The control keyboard is for you to control the device via the special keyboard. Transparent COM (adapter) is to connect to the PC to transfer data directly. Protocol COM is for card overlay function. Network keyboard is for you to use the special keyboard to control the device. PTZ matrix is to connect to the peripheral matrix control.
- Baud rate: You can select proper baud rate.

- Data bit: You can select proper data bit. The value ranges from 5 to 8.
- Stop bit: There are three values: 1/1.5/2.
- Parity: there are five choices: none/odd/even/space mark.

System default setup is:

- Function: Console
- Baud rate:115200
- Data bit:8
- Stop bit:1
- Parity: None

After completing all the setups please click save button, system goes back to the previous menu.

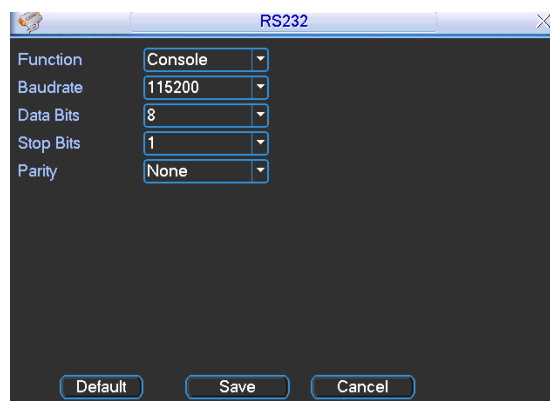

Figure 5-8

5.3.5 Network

Here is for you to input network information. See Figure 5-9.

- IP address: Here you can input IP address.
- DHCP: It is to auto search IP. When enable DHCP function, you can not modify IP/Subnet mask /Gateway. These values are from DHCP function. If you have not enabled DHCP function, IP/Subnet mask/Gateway display as zero. You need to disable DHCP function to view current IP information. Besides, when PPPoE is operating, you can not modify IP/Subnet mask /Gateway.
- TCP port: Default value is 37777.
- UDP port: Default value is 37778.
- HTTP port: Default value is 80.
- RTSP port: Default value is 554.
- Max connection: system support maximal 20 users. 0 means there is no connection limit.
- Preferred DNS server: DNS server IP address.
- Alternate DNS server: DNS server alternate address.
- Transfer mode: Here you can select the priority between fluency/video qualities.
- LAN download: System can process the downloaded data first if you enable this function. The download speed is 1.5X or 2.0X of the normal speed.

After completing all the setups please click save button, system goes back to the previous

menu.

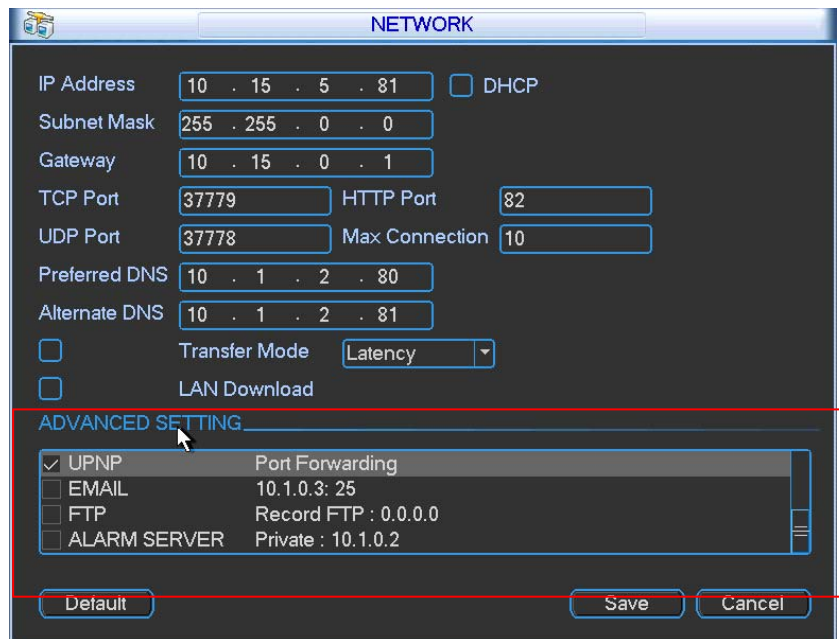

Figure 5-9

5.3.5.1 Advanced Setup

Advanced setup interface is shown as in Figure 5-10. Please draw a circle to enable corresponding function and then double click current item to go to setup interface.

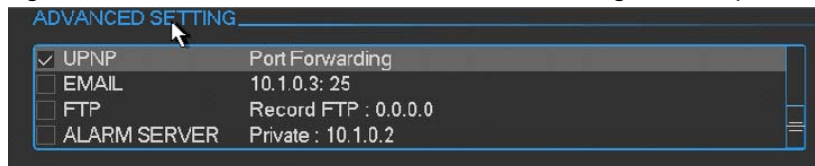

Figure 5-10

5.3.5.2 IP Filter

IP filter interface is shown as in Figure 5-11. You can add IP in the following list. The list supports max 64 IP addresses.

Please note after you enabled this function, only the IP listed below can access current DVR.

If you disable this function, all IP addresses can access current DVR.

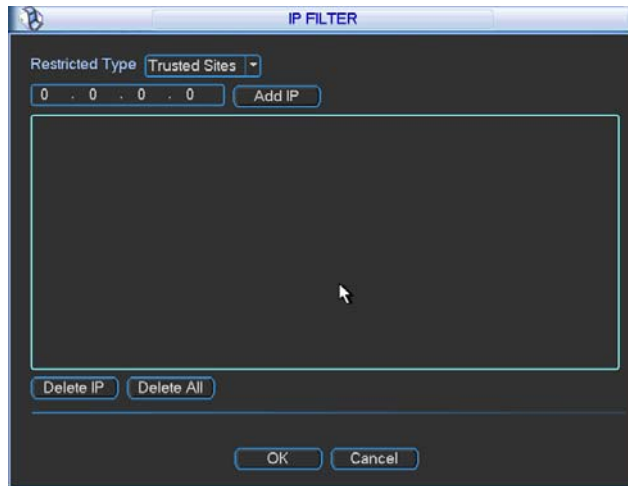

Figure 5-11

5.3.5.3 NTP Setup

You need to install SNTP server (Such as Absolute Time Server) in your PC first. In Windows XP OS, you can use command “net start w32time” to boot up NTP service. NTP setup interface is shown as in Figure 5-12.

- Host IP: Input your PC address.
- Port: This series DVR supports TCP transmission only. Port default value is 123.
- Update interval: minimum value is 1. Max value is 65535. (Unit: minute)
- Time zone: select your corresponding time zone here.

Here is a sheet for your time zone setup.

City /Region Name	Time Zone
London	GMT+0
Berlin	GMT+1
Cairo	GMT+2
Moscow	GMT+3
New Deli	GMT+5
Bangkok	GMT+7
Beijing (Hong Kong)	GMT+8
Tokyo	GMT+9
Sydney	GMT+10
Hawaii	GMT-10
Alaska	GMT-9
Pacific Time(P.T)	GMT-8
American Mountain Time(M.T)	GMT-7
American Central Time(C.T)	GMT-6
American Eastern Time(E.T)	GMT-5
Atlantic Time	GMT-4
Brazil	GMT-3
Middle Atlantic Time	GMT-2

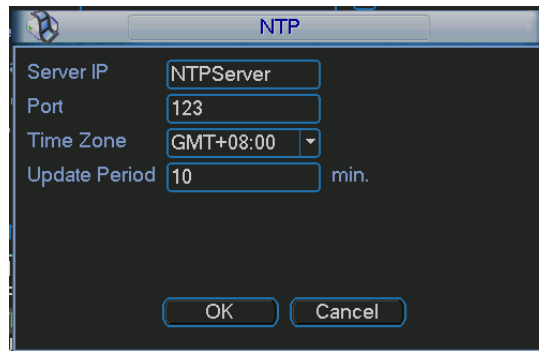

Figure 5-12

5.3.5.4 Multiple Cast Setup

Multiple-cast setup interface is shown as in Figure 5-13.

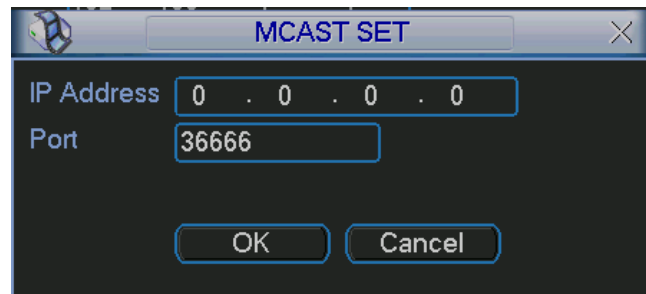

Figure 5-13

Here you can set a multiple cast group. Please refer to the following sheet for detailed information.

- IP multiple cast group address
 - 224.0.0.0-239.255.255.255
 - “D” address space
 - The higher four-bit of the first byte=“1110”
- Reserved local multiple cast group address
 - 224.0.0.0-224.0.0.255
 - TTL=1 When sending out telegraph
 - For example
 - 224.0.0.1 All systems in the sub-net
 - 224.0.0.2 All routers in the sub-net
 - 224.0.0.4 DVMRP router
 - 224.0.0.5 OSPF router
 - 224.0.0.13 PIMv2 router
- Administrative scoped addressees
 - 239.0.0.0-239.255.255.255
 - Private address space
 - Like the single broadcast address of RFC1918
 - Can not be used in Internet transmission

- Used for multiple cast broadcast in limited space.

Except the above mentioned addresses of special meaning, you can use other addresses.
For example:

Multiple cast IP: 235.8.8.36

Multiple cast PORT: 3666.

After you logged in the Web, the Web can automatically get multiple cast address and add it to the multiple cast groups. You can enable real-time monitor function to view the view.
Please note multiple cast function applies to special series only.

5.3.5.5 PPPoE

PPPoE interface is shown as in Figure 5-14.

Input “PPPoE name” and “PPPoE password” you get from your ISP (Internet service provider).

Click save button, you need to restart to activate your configuration.

After rebooting, DVR will connect to internet automatically. The IP in the PPPoE is the DVR dynamic value. You can access this IP to visit the unit.

Figure 5-14

5.3.5.6 DDNS Setup

DDNS setup interface is shown as in Figure 5-15.

You need a PC of fixed IP in the internet and there is the DDNS software running in this PC. In other words, this PC is a DNS (domain name server).

In network DDNS, please select DDNS type and highlight enable item. Then please input your PPPoE name you get from you IPS and server IP (PC with DDNS) . Click save button and then reboot system.

Click save button, system prompts for rebooting to get all setup activated.

After rebooting, open IE and input as below:

http: //(DDNS server IP)/(virtual directory name)/webtest.htm

e.g.: http: //10.6.2.85/DVR _DDNS/webtest.htm.)

Now you can open DDNSServer web search page.

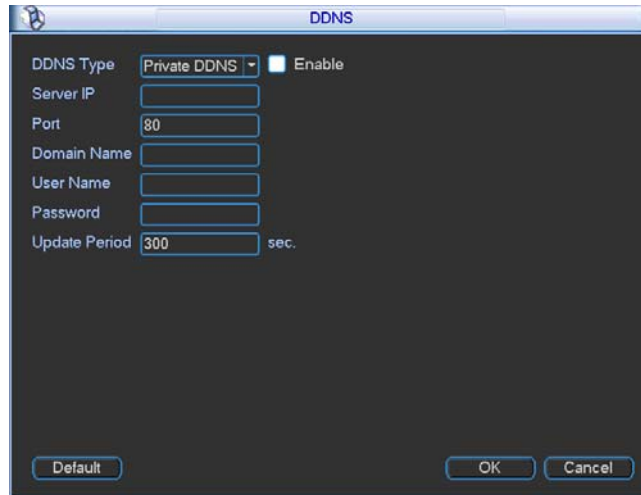

Figure 5-15

Please note NNDS type includes: CN99 DDNS、NO-IP DDNS、Private DDNS、Dyndns DDNS and sysdns DDNS. All the DDNS can be valid at the same time, you can select as you requirement.

Private DDNS function shall work with special DDNS server and special Professional Surveillance Software (PSS).

5.3.5.7 UPNP

The UPNP protocol is to establish a mapping relationship between the LAN and the WAN. Please input the router IP address in the LAN in Figure 5-9. Double click the UPNP item in Figure 5-9, you can see the following interface. See Figure 5-16.

- UPNP on/off : Turn on or off the UPNP function of the device.
- Status: When the UPNP is offline, it shows as “Unknown”. When the UPNP works it shows “Success”
- Router LAN IP: It is the router IP in the LAN.
- WAN IP: It is the router IP in the WAN.
- Port Mapping list: The port mapping list here is the one to one relationship with the router’s port mapping setting.
- Enable Switch : It shows that the function of port mapping is enabled in this port.
- List:
 - ✧ Service name: Defined by user.
 - ✧ Protocol: Protocol type
 - ✧ Internal port: Port that has been mapped in the router.
 - ✧ External port: Port that has been mapped locally.
- Default: UPNP default port setting is the HTTP, TCP and UDP of the DVR.
- Add to the list: Click it to add the mapping relationship.
- Delete: Click it to remove one mapping item.

Double click one item; you can change the corresponding mapping information. See Figure 5-17.

Important:

When you are setting the router external port, please use 1024~5000 port. Do not use well-known port 1~255 and the system port 256~1023 to avoid conflict.

For the TCP and UDP, please make sure the internal port and external port are the same to guarantee the proper data transmission.

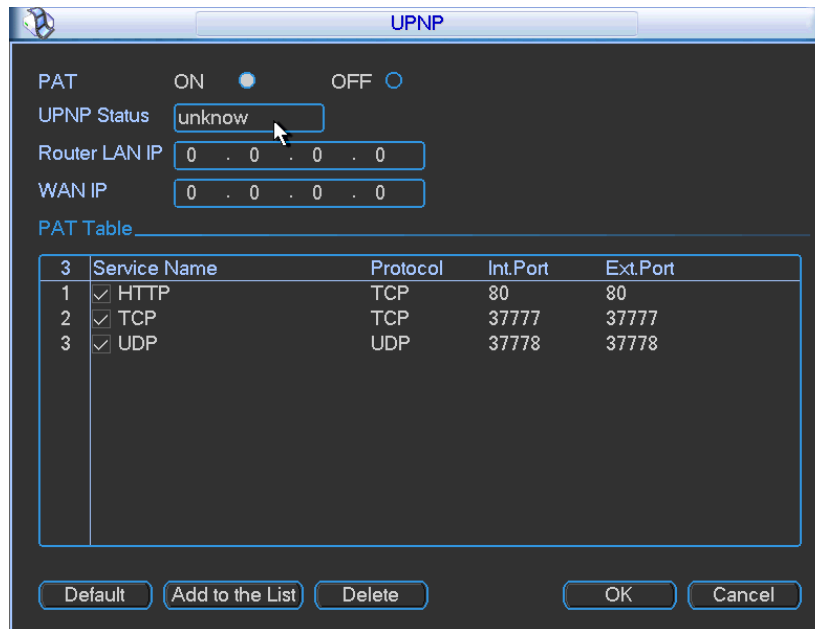

Figure 5-16

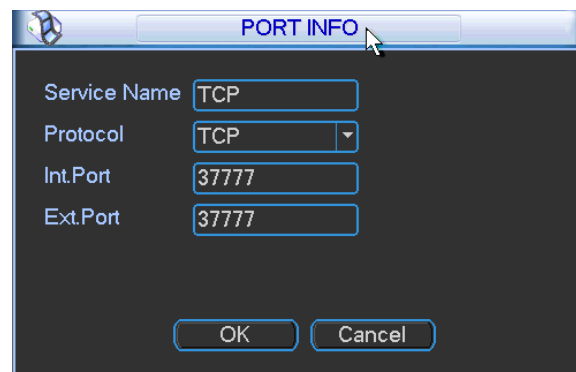

Figure 5-17

5.3.5.8 Email

The email interface is shown as below. See Figure 5-18.

- SMTP server: Please input your email SMTP server IP here.
- Port: Please input corresponding port value here.
- User name: Please input the user name to login the sender email box.
- Password: Please input the corresponding password here.
- Sender: Please input sender email box here.
- Title: Please input email subject here. System support English character and Arabic number. Max 32-digit.

- Receiver: Please input receiver email address here. System max supports 3 email boxes.
- SSL enable: System supports SSL encryption box.
- Interval: The send interval ranges from 0 to 3600 seconds. 0 means there is no interval.
- Health email enable: Please check the box here to enable this function. This function allows the system to send out the test email to check the connection is OK or not.
- Interval: Please check the above box to enable this function and then set the corresponding interval. System can send out the email regularly as you set here. Click the Test button, you can see the corresponding dialogue box to see the email connection is OK or not. See Figure 5-19.

Please note system will not send out the email immediately when the alarm occurs. When the alarm, motion detection or the abnormality event activates the email, system sends out the email according to the interval you specified here. This function is very useful when there are too many emails activated by the abnormality events, which may result in heavy load for the email server.

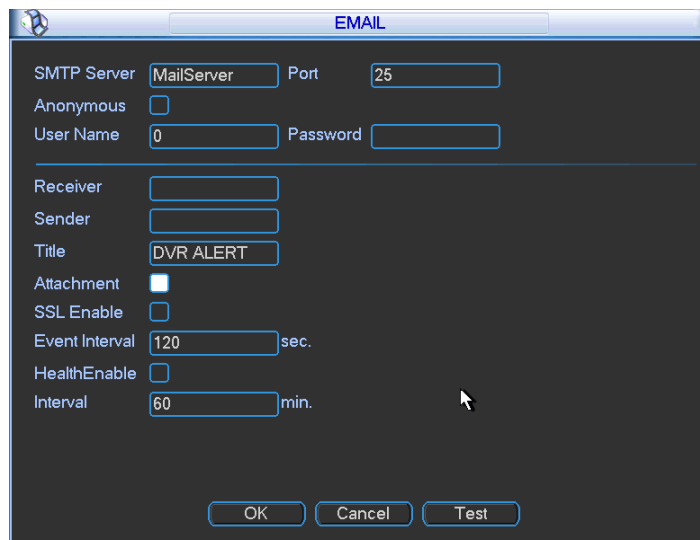

Figure 5-18

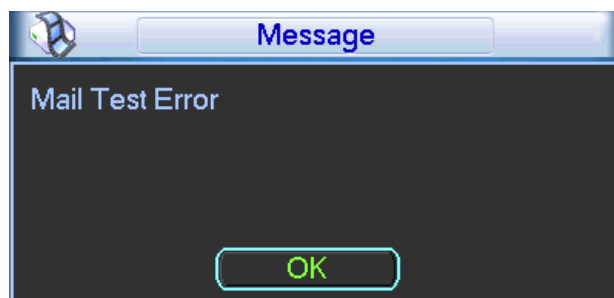

Figure 5-19

5.3.5.9 FTP

You need to download or buy FTP service tool (such as Ser-U FTP SERVER) to establish

FTP service.

Please install Ser-U FTP SERVER first. From “start” -> “program” -> Serv-U FTP Server -> Serv-U Administrator. Now you can set user password and FTP folder. Please note you need to grant write right to FTP upload user. See Figure 5-20.

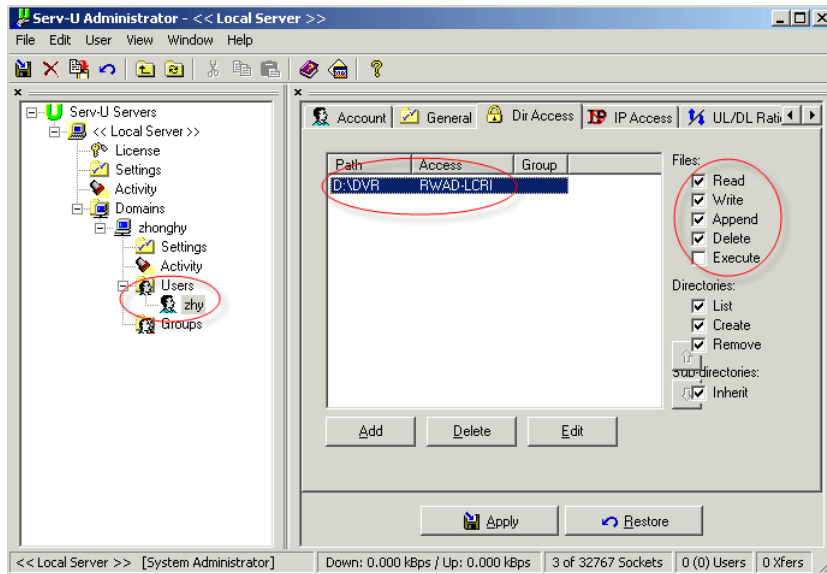

Figure 5-20

You can use a PC or FTP login tool to test setup is right or not.

For example, you can login user ZHY to [FTP://10.10.7.7](ftp://10.10.7.7) and then test it can modify or delete folder or not. See Figure 5-21.

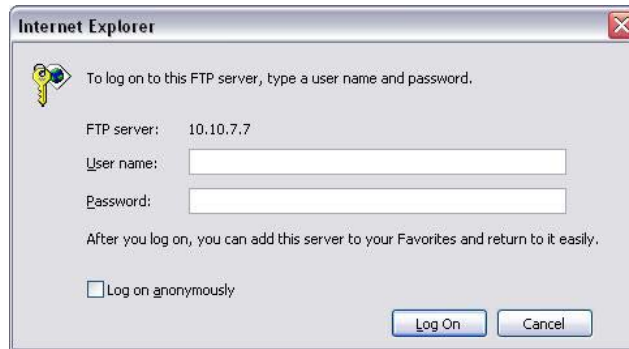

Figure 5-21

System also supports upload multiple DVRs to one FTP server. You can create multiple folders under this FTP.

In Figure 5-9, select FTP and then double click mouse. You can see the following interface. See Figure 5-22.

Please highlight the icon  in front of Enable to activate FTP function.

Here you can input FTP server address, port and remote directory. When remote directory is null, system automatically create folders according to the IP, time and channel.

User name and password is the account information for you to login the FTP.

File length is upload file length. When setup is larger than the actual file length, system will

upload the whole file. When setup here is smaller than the actual file length, system only uploads the set length and auto ignore the left section. When interval value is 0, system uploads all corresponding files.

After completed channel and weekday setup, you can set two periods for one each channel.

Click the Test button, you can see the corresponding dialogue box to see the FTP connection is OK or not. See Figure 5-23.

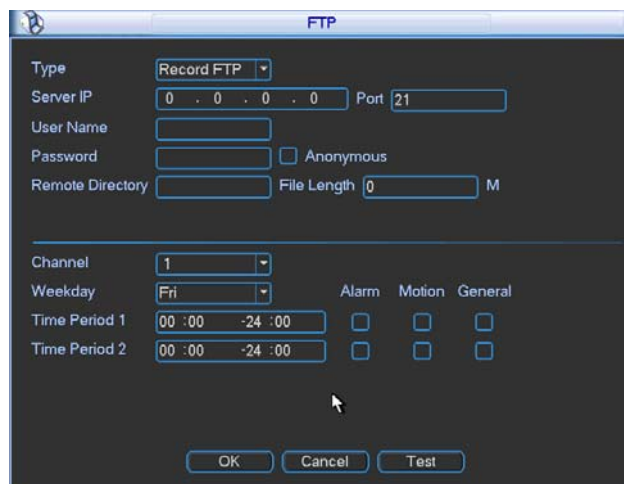

Figure 5-22

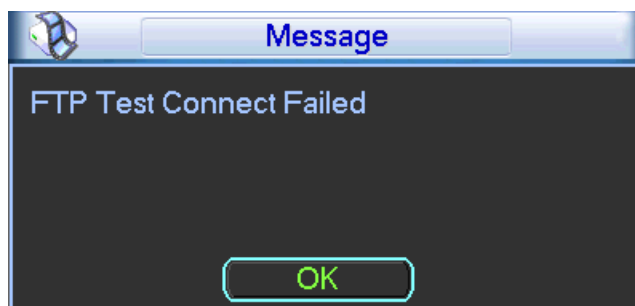

Figure 5-23

5.3.5.10 Alarm Centre

This interface is reserved for you to develop.

5.3.6 Alarm

Please refer to chapter 4.6 Alarm Setup and Activation.

5.3.7 Detect

Please refer to chapter 4.5 Detect.

5.3.8 Pan/Tilt/Zoom

The pan/tilt/zoom setup includes the following items. Please select channel first. See Figure 5-24.

- Protocol: Select corresponding PTZ protocol such as PELCOD.
- Address: input corresponding PTZ address.
- Baud rate: Select baud rate.
- Data bit: Select data bit.
- Stop bit: Select stop bit.
- Parity: There are three choices: none/odd/even.

After completed all the setups please click save button, system goes back to the previous menu.

For detailed setup, please refer to chapter 4.9 preset/patrol/pattern/scan.

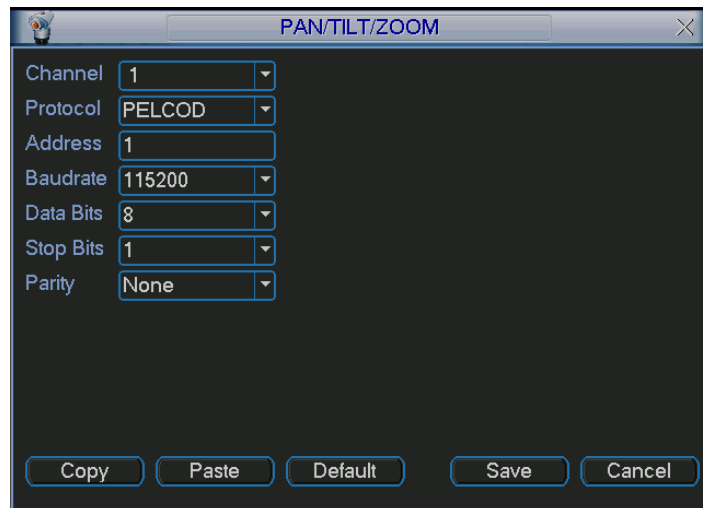





Figure 5-24

5.3.9 Display

Display setup interface is shown as below. See Figure 5-25.

- Transparency: Here is for you to adjust transparency. The value ranges from 128 to 255.
- Channel name: Here is for you to modify channel name. System max support 25-digit (The value may vary due to different series). Please note all your modification here only applies to DVR local end. You need to open web or client end to refresh channel name.
- Time display: You can select to display time or not when system is playback.
- Channel display: You can select to channel name or not when system is playback.
- Resolution: There are four options: 1280×1024(default), 1280×720, 1024×768, 800×600. Please note the system needs to reboot to activate current setup.
- Enable tour: Activate tour function.
- Interval: System supports 1/4/8/9/16-window tour. Input proper interval value here. The value ranges from 5-120 seconds. In tour process, you can use mouse or click Shift to turn on window switch function.  Stands for opening switch function,  stands for closing switch function.
- Monitor tour type: System support 1/8-window tour.
- Alarm tour type: System support 1/8-window tour.

Please highlight icon  to select the corresponding function.

After completing all the setups please click save button, system goes back to the previous menu.

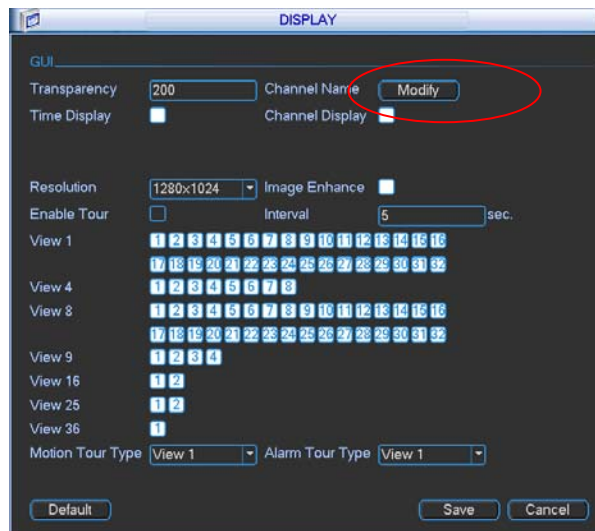

Figure 5-25

In Figure 5-25, click modify button after channel. You can see an interface is shown as in Figure 5-26. Please note all your modification here applies to local end only. You need to refresh web or client-end to get the latest channel name. System max support 25-digital character.



Figure 5-26



In tour mode, you can see the following interface. On the right corner, right click mouse or click shift button, you can control the tour. There are two icons:  stands for enabling window switch and  stands for disabling window function. See Figure 5-27.



Figure 5-27

5.3.10 Default

Click default icon, system pops up a dialogue box. You can highlight  to restore default factory setup. See Figure 5-26.

- Select all
- General
- Encode
- Schedule
- RS232
- Network
- Alarm
- Detect
- Pan/tilt/zoom
- Display
- Channel name

Please highlight icon  to select the corresponding function.

After all the setups please click save button, system goes back to the previous menu.

Warning!

System menu color, language, time display mode, video format, IP address, user account will not maintain previous setup after default operation!

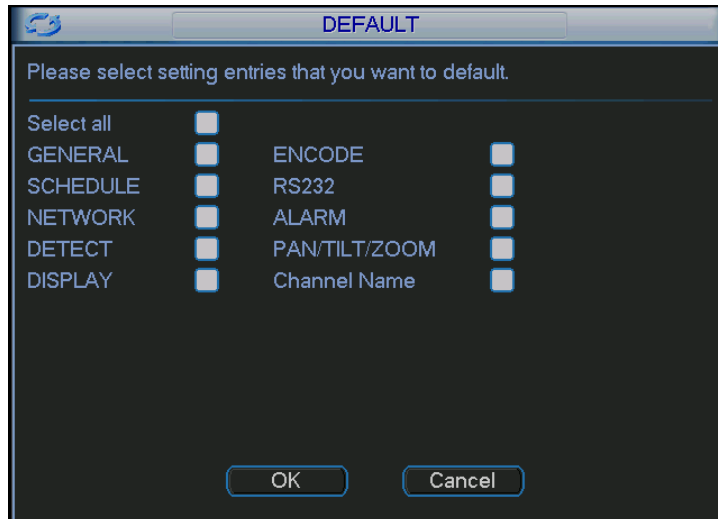

Figure 5-28

5.4 Search

Please refer to chapter 4.3 Search.

5.5 Advanced

Double click advanced icon in the main window, the interface is shown as below. See Figure 5-29. There are total eight function keys: HDD management, alarm output, abnormality, manual record, account, auto maintenance, TV adjust and video matrix.

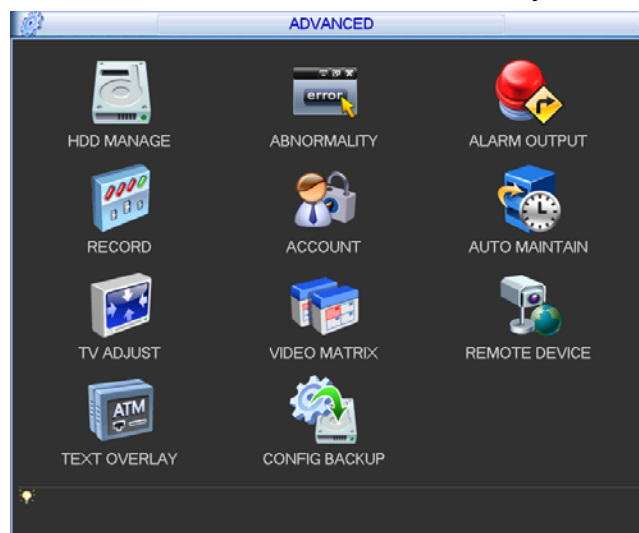

Figure 5-29

5.5.1 HDD Management

Here is for you to view and implement hard disk management. See Figure 5-30. You can see current HDD type, status, capacity and record time. When HDD is working properly, system is shown as O. When HDD error occurred, system is shown as X.

- Alarm set: Click alarm set button, the interface is shown as below. See Figure 5-31. (This interface is just like the abnormality setup). Please refer to chapter 5.5.2 for detailed information.
- HDD operation: You can select HDD mode from the dropdown list such as read-only or you can erase all data in the HDD. Please note system needs to reboot to get all the modification activated.

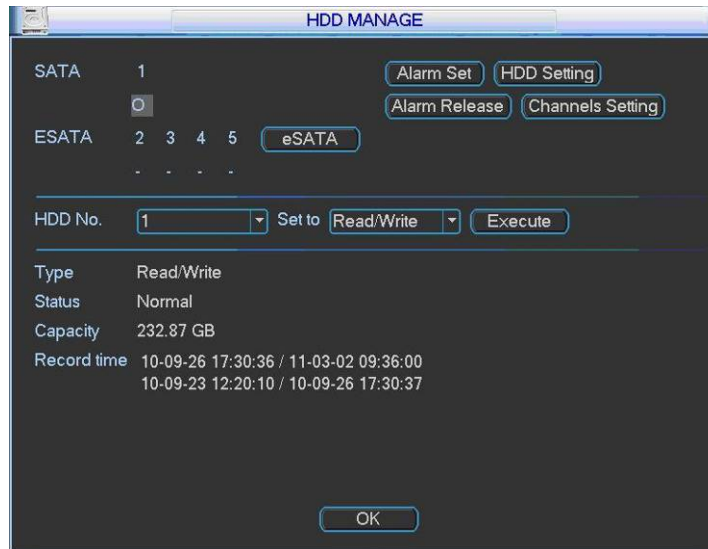



Figure 5-30

Please highlight icon  to select the corresponding function.

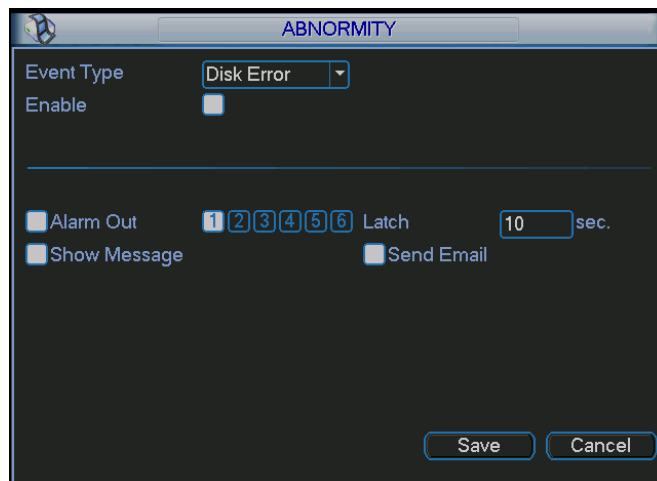

Figure 5-31

For the HDD group setup operation, please note:

- Each channel's records can be stored into the specified HDD Group.
- Each HDD Group is corresponding to several hard disks, while one hard disk is only included in one HDD Group.
- Each channel is only corresponding with one HDD Group, while one HDD Group can store records from several channels.

- HDD Group is only available for read-write HDD and self-defined disks, other types of hard disks cannot be set as HDD Group.

Important:

- e-SATA also supports this function, you can manage e-SATA hard disk as local hard disk.
- Current series software version can only set the HDD group operation of the read-write HDDs. It is not for the redundancy HDD.

HDD Setting

Click the button “HDD Settings” at the top right corner of the Figure 5-30, system will pop up an interface as below. See Figure 5-32.

The number of hard disk from 1 to 12 is shown in the “HDD No.” column. If there is a mark  in the front of the number, it means this interface have access to the hard disk, otherwise it does not have access to the hard disk.

The “HDD Group” column lists the HDD Group number of current hard disk. When you are setting the HDD Group, please check the box of the hard disk, and then choose the corresponding HDD Group number and save the settings.

In Figure 5-32, you can see the system has two working hard disks at the 6th and 7th position, and the 6th position hard disk belongs to HDD Group 1, the 7th position hard disk belongs to HDD Group 2.

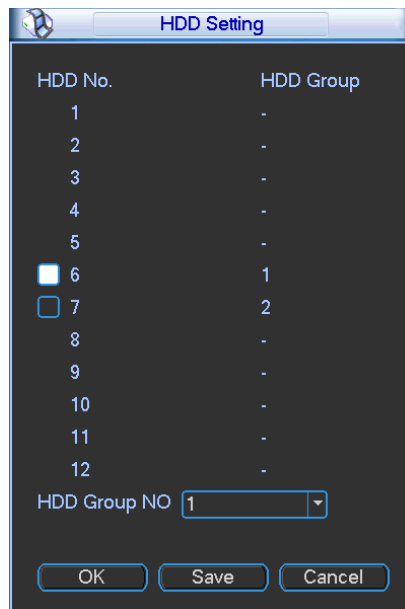

Figure 5-32

In Figure 5-33, you can see the 6th and 7th position hard disks both belong to HDD Group 2.

Important

Once you change the HDD Group settings, system will pack the records and snapshots,

and then reboot.

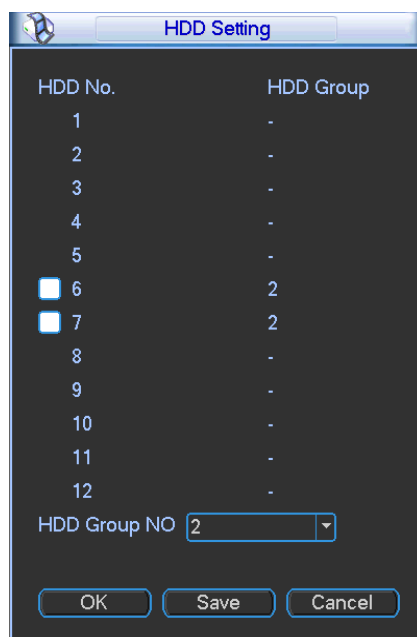

Figure 5-33

Channels Setting

Click the button named with “Channels Settings” at the top right corner of the Figure 5-30, system will pop up an interface shown as in Figure 5-34.

When you are setting the configurations of the channels setting, please select relevant channels first (such as channel 1 to 16), and then select the HDD Group NO. Please click the Save button to save current setup.

The Figure 5-34 and Figure 5-35 show that channels 1 to 16 are associated to HDD Group NO 1, and channels 17 to 32 are associated to HDD Group NO 2. Therefore the records of channels 1 to 16 are stored into the hard disk(s) which belong to HDD Group NO 1, and the records of channels 17 to 32 are stored into the hard disk(s) which belong to HDD Group NO 2.

Important

Once you change the HDD Group settings, system will pack the records and snapshots, and then reboot.

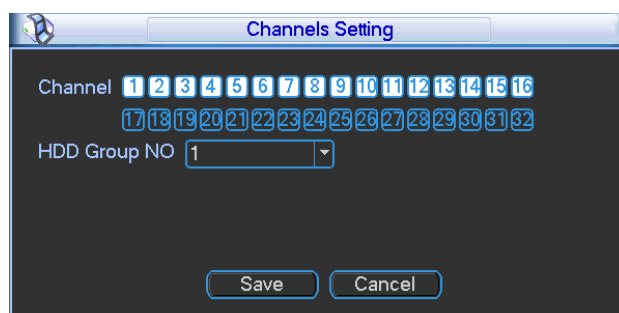

Figure 5-34

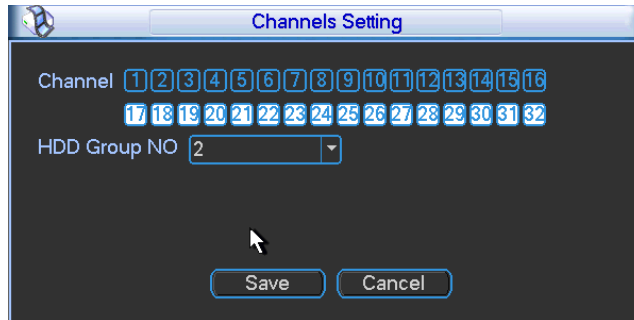

Figure 5-35

5.5.2 Abnormity

Abnormity interface is shown as in Figure 5-36.

- Event type: There are several options for you such as disk error, no disk, disconnection, IP conflict and etc.
- Alarm output: Please select alarm activation output port (multiple choices).
- Latch: Here you can set corresponding delaying time. The value ranges from 10s-300s. System automatically delays specified seconds in turning off alarm and activated output after external alarm cancelled.
- Show message: system can pop up the message in the local screen to alert you when alarm occurs.
- Alarm upload: System can upload the alarm signal to the network (including alarm centre) if you enabled current function.
- Send email: System can send out email to alert you when alarm occurs.
- Buzzer: Highlight the icon to enable this function. The buzzer beeps when alarm occurs.

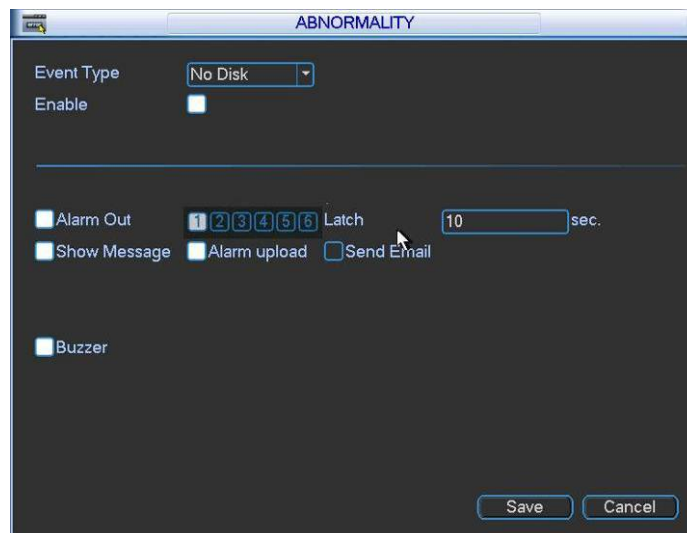



Figure 5-36

5.5.3 Alarm Output

Here is for you to set proper alarm output.

Please highlight icon  to select the corresponding alarm output. After all the setups please click OK button, system goes back to the previous menu. See Figure 5-37.

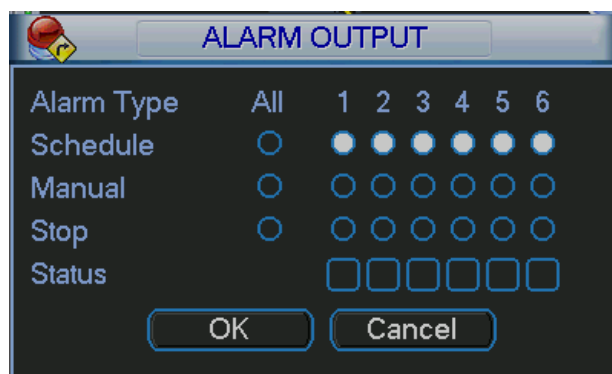

Figure 5-37

5.5.4 Manual Record

Please refer to chapter 4.2.2 manual record.

5.5.5 Account

Here is for you to implement account management. See Figure 5-38. Here you can:

- Add new user
- Modify user
- Add group
- Modify group
- Modify password.

For account management please note:

- For the user account name and the user group, the string max length is 6-byte. The backspace in front of or at the back of the string is invalid. There can be backspace in the middle. The string includes the valid character, letter, number, underline, subtraction sign, and dot.
- System account adopts two-level management: group and user. No limit to group or user amount.
- For group or user management, there are two levels: admin and user.
- The user name and group name can consist of eight bytes. One name can only be used once. There are four default users: admin/888888/666666 and hidden user "default". Except user 6666, other users have administrator right.
- Hidden user "default" is for system interior use only and can not be deleted. When there is no login user, hidden user "default" automatically login. You can set some rights such as monitor for this user so that you can view some channel view without login.
- One user should belong to one group. User right can not exceed group right.
- About reusable function: this function allows multiple users use the same account to login.

After all the setups please click save button, system goes back to the previous menu.

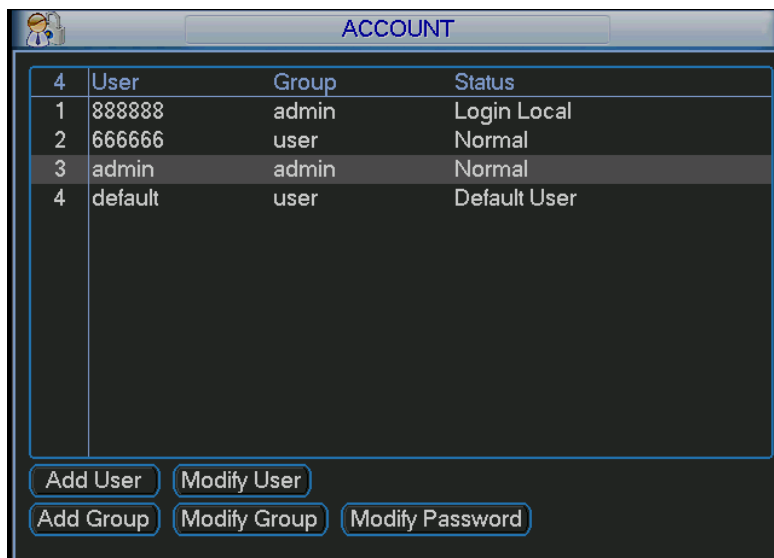

Figure 5-38

5.5.5.1 Modify Password

Click password button, the interface is shown as in Figure 5-39.

Here you can modify account password.

Please select the account from the dropdown list, input the old password and then input the new password twice. Click the Save button to confirm current modification.

For the users of user account right, it can modify password of other users.

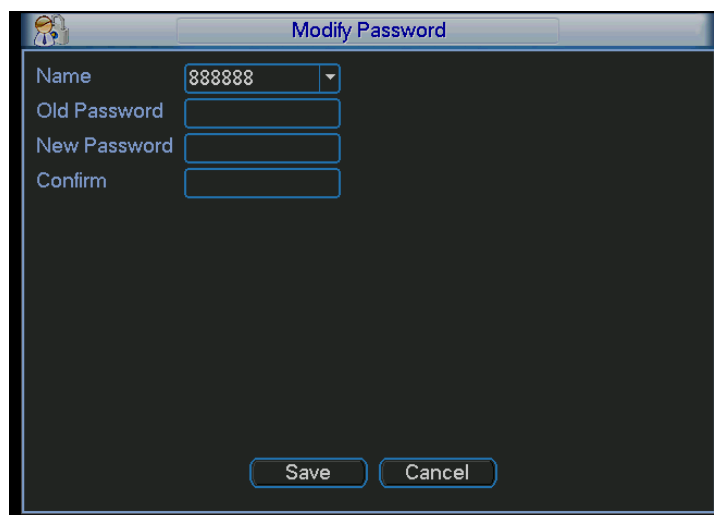

Figure 5-39

5.5.5.2 Add/Modify Group

Click add group button, the interface is shown as below. See Figure 5-40.

Here you can input group name and then input some memo information if necessary.

There are total 60 rights such as control panel, shut down, real-time monitor, playback,

record, record file backup, PTZ, user account, system information view, alarm input/output setup, system setup, log view, clear log, upgrade system, control device and etc.
 The modify group interface is similar to the Figure 5-40.

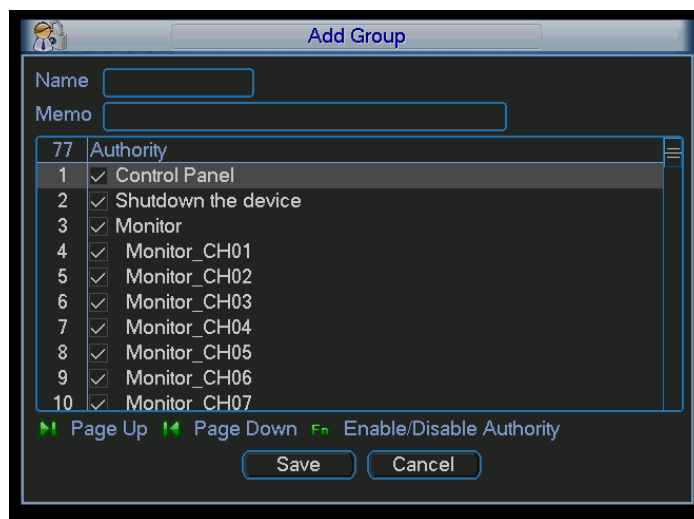

Figure 5-40

5.5.5.3 Add/Modify User

Click add user button, the interface is shown as in Figure 5-41.

Please input the user name, password, select the group it belongs to from the dropdown list.

Then you can check the corresponding rights for current user.

For convenient user management, usually we recommend the general user right is lower than the admin account.

The modify user interface is similar to Figure 5-41.

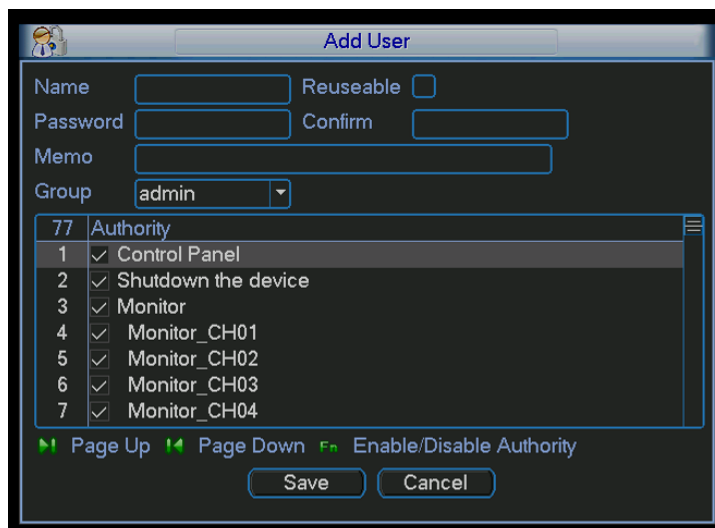

Figure 5-41

5.5.6 Auto Maintain

Here you can set auto-reboot time and auto-delete old files setup. You can set to delete the files for the specified days. See Figure 5-42.

You can select proper setup from dropdown list.

After all the setups please click save button, system goes back to the previous menu.

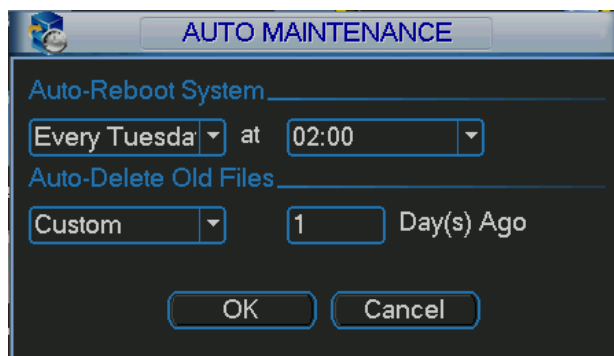

Figure 5-42

5.5.7 TV Adjust

Here is for you to adjust TV output setup. See Figure 5-43.

Please drag slide bar to adjust each item.

After all the setups please click OK button, system goes back to the previous menu.



Figure 5-43

5.5.8 Video Matrix

Here you can set matrix output channel and its interval. See Figure 5-44.

It can support the 1/4/9/16-window sport tour and you can specify the interval.

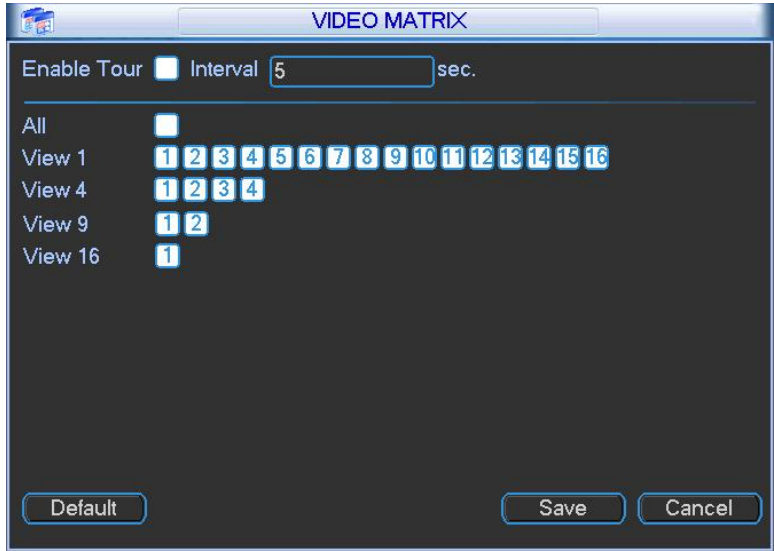

Figure 5-44

5.5.9 Remote Device

The remote device interface is shown as in Figure 5-45. Here you can set IPC IP address, port, remote device channel number, user name and its password.

IPC port number is 37777; remote device channel number is 1 by default. IPC user name is admin and password is admin.

The 4-ch device max. supports 4-ch D1 IPC or 2-ch 720P IPC or 1-ch 1080P IPC.

The 8-ch device max. supports 8-ch D1 IPC or 4-ch 720P IPC or 2-ch 1080P IPC.

The 16-ch device max. supports 16-ch D1 IPC or 8-ch 720P IPC or 4-ch 1080P IPC.

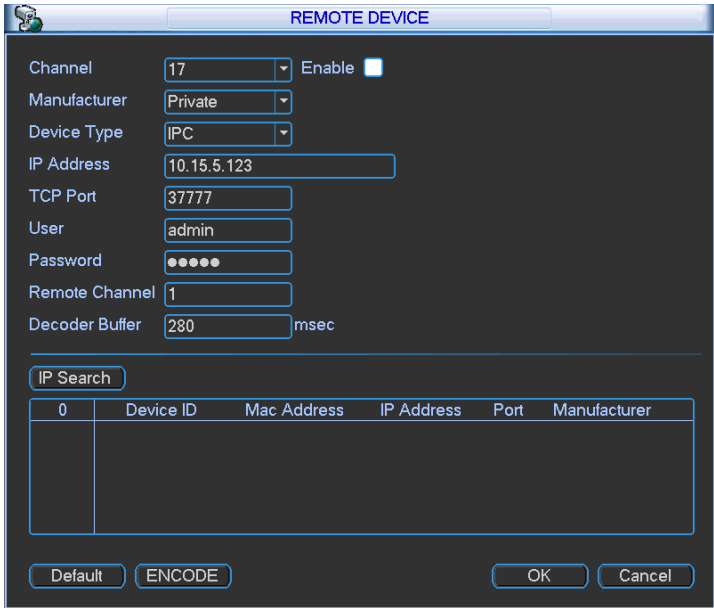

Figure 5-45

Note: this device also supports IPCs from the third parties (i.e. Sony, AXIS, Samsung, Panasonic and etc.)

5.5.10 Text Overlay

The card overlay function is for financial areas. It includes Sniffer, information analysis and title overlay function. The Sniffer mode includes COM and network.

5.5.10.1 COM Type

The COM interface is shown as below. See Figure 5-46.

- Protocol: Please select from the dropdown list.
- Setting: Click COM setting button, the interface is shown as in RS232 interface. Please refer to Chapter 5.3.4 RS232.
- Overlay channel: Please select the channel you want to overlay the card number.
- Overlay mode: There are two options: preview and encode. Preview means overlay the card number in the local monitor video. Encode means overlay the card number in the record file.
- Overlay Position: Here you can select the proper overlay position from the dropdown list.

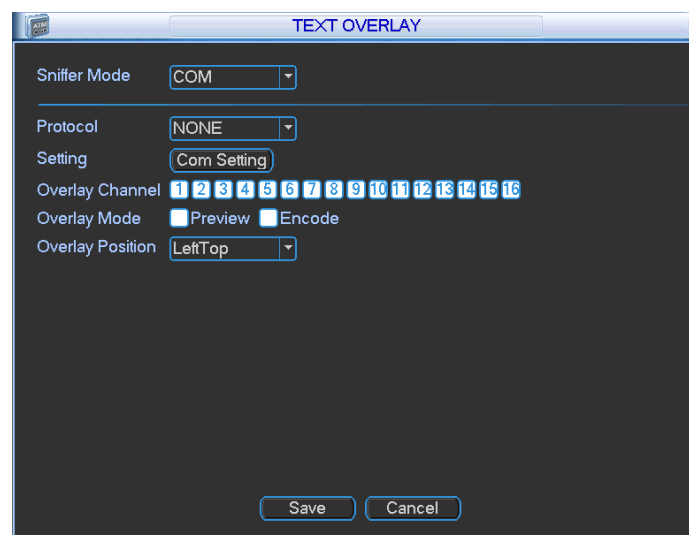

Figure 5-46

5.5.10.2 Network Type

The network type interface is shown as below. See Figure 5-47.

Here we take the ATM/POS protocol to continue.

There are two types: with or without the protocol according to client's requirements.

With the protocol

For ATM/POS with the protocol, you just need to set the source IP, destination IP (sometimes you need to input corresponding port number).

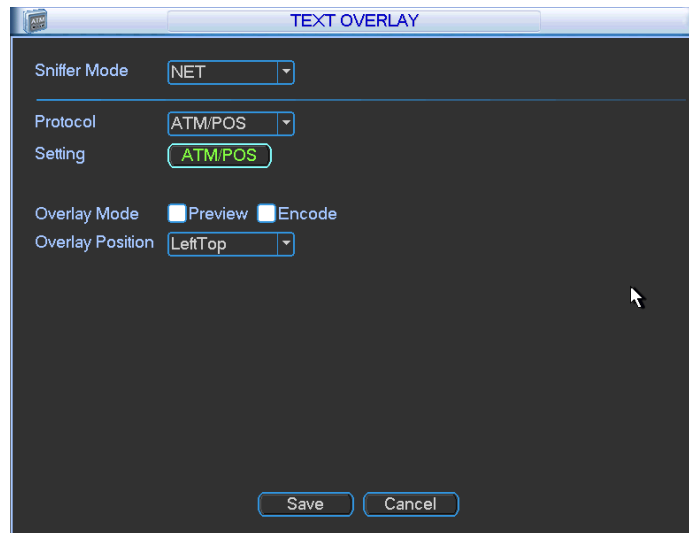

Figure 5-47

Without the protocol

For the ATM/POS without the protocol, the interface is shown as in Figure 5-48.

Source IP refers to host IP address that sends out information (usually it is the device host.)

Destination IP refers to other systems that receive information.

Usually you do not need to set source port and target port.

There are total four groups IP. The record channel applies to one group (optional) only.

Six frame ID groups verification can guarantee information validity and legal.

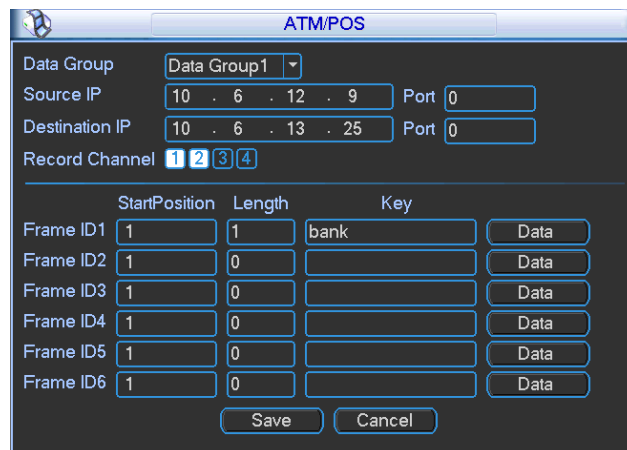

Figure 5-48

Click Data button you can see an interface is shown as in Figure 5-49.

Here you can set offset value, length, title according to your communication protocol and data package. .

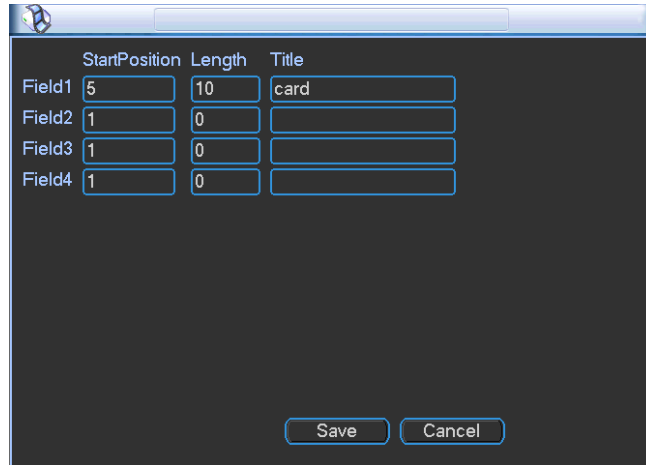

Figure 5-49

5.5.11 Config File Backup

The configuration file backup interface is shown as below. See Figure 5-50. This function allows you to copy current system configuration to other devices.

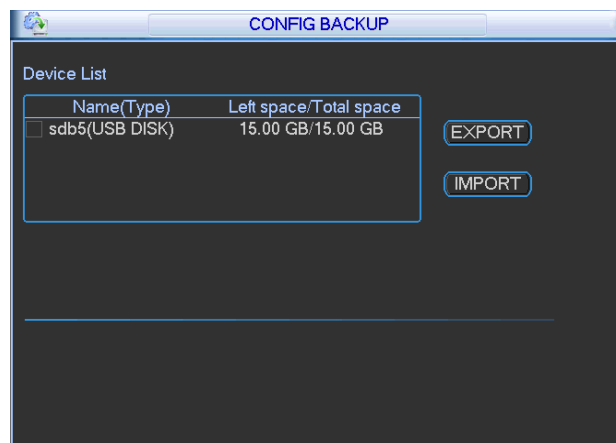

Figure 5-50

5.6 Information

Here is for you to view system information. There are total five items: HDD (hard disk information), BPS (data stream statistics), Log and version, and online user. See Figure 5-51.

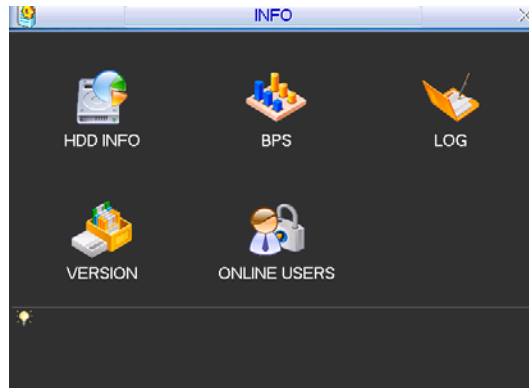

Figure 5-51

5.6.1 HDD Information

Here is to list hard disk type, total space, free space, video start time and status. See See Figure 5-52. ○ means current HDD is normal. X means there is error. - means there is no HDD.

If disk is damaged, system shows as “?”. Please remove the broken hard disk before you add a new one.

Once there is a hard disk conflict, please check hard disk time and system time is the same or not. Please go to setting then general to modify system time. At last, reboot the system to solve this problem.

After system booted up, if there is any conflict, system goes to HDD information interface directly. Please note, system does not ask you to deal with it forcedly.

When HDD conflict occurs, you can check system time and HDD time are identical or not. If they are not identical, please go to General (Chapter 5.3.1) to adjust system time or go to HDD Management (Chapter 5.5.1) to format HDD and then reboot the DVR.

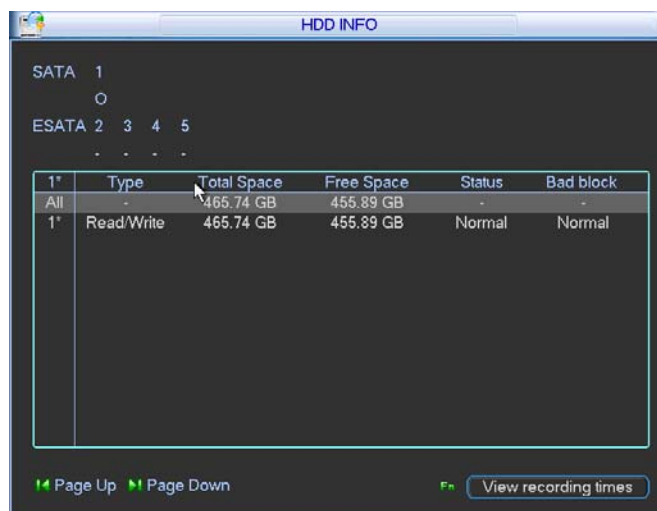

Figure 5-52

Tips:

Please click Fn button or left click mouse to view HDD record time and HDD type and time.

5.6.2 BPS

Here is for you to view current video data stream (KB/s) and occupied hard disk storage (MB/h). See Figure 5-53.

Channel	Kb/S	MB/H	Wave	Channel	Kb/S	MB/H	Wave
1	67	28	[Green Bar]	17	0	0	[Green Bar]
2	35	13	[Green Bar]	18	0	0	[Green Bar]
3	35	13	[Green Bar]	19	0	0	[Green Bar]
4	34	13	[Green Bar]	20	0	0	[Green Bar]
5	35	13	[Green Bar]	21	0	0	[Green Bar]
6	35	13	[Green Bar]	22	0	0	[Green Bar]
7	35	13	[Green Bar]	23	0	0	[Green Bar]
8	35	13	[Green Bar]	24	0	0	[Green Bar]
9	36	13	[Green Bar]	25	0	0	[Green Bar]
10	36	13	[Green Bar]	26	0	0	[Green Bar]
11	36	13	[Green Bar]	27	0	0	[Green Bar]
12	36	13	[Green Bar]	28	0	0	[Green Bar]
13	36	13	[Green Bar]	29	0	0	[Green Bar]
14	36	13	[Green Bar]	30	0	0	[Green Bar]
15	36	13	[Green Bar]	31	0	0	[Green Bar]
16	36	13	[Green Bar]	32	0	0	[Green Bar]

Figure 5-53

5.6.3 Log

Here is for you to view system log file. System lists the following information. See Figure 5-54.

Log types include system operation, configuration operation, data management, alarm event, record operation, log clear and etc.

Please select start time and end time, then click search button. You can view the log files.

System max displays 100 logs in one page. It can max save 1024 log files.

Please page up/down button to view if there are more than ten files.

System also supports the backup function; you can click the backup button to save the log files in the USB devices.

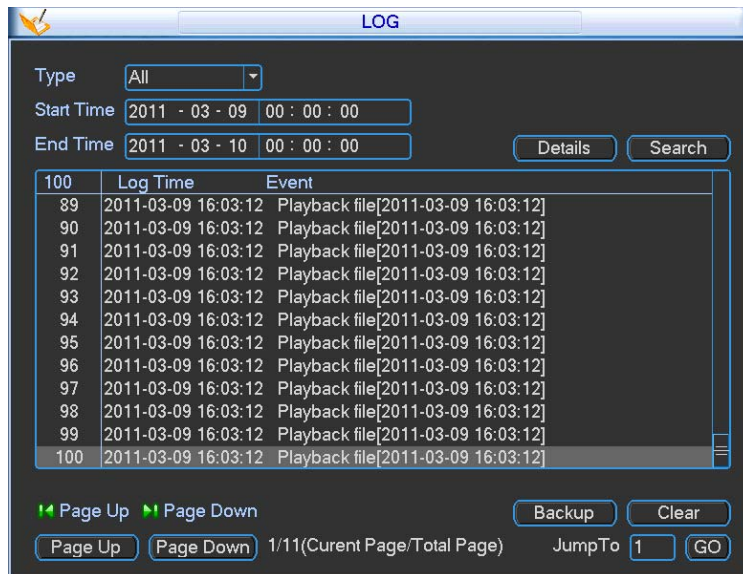

Figure 5-54

Click the Details button or double click the log item, you can view the detailed information. See Figure 5-55.

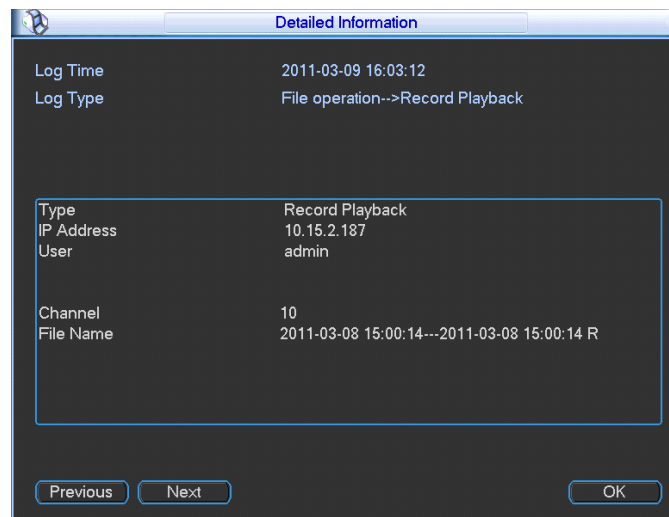

Figure 5-55

5.6.4 Version

Here is for you to view some version information. See Figure 5-56.

- Channel
- Alarm in
- Alarm out
- System version:
- Build Date

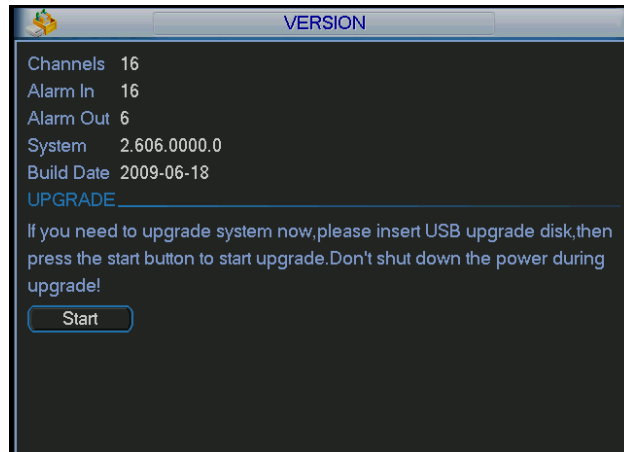

Figure 5-56

5.6.5 Online Users

Here is for you manage online users. See Figure 5-57.

You can disconnect one user or block one user if you have proper system right. Max disconnection setup is 65535 seconds.

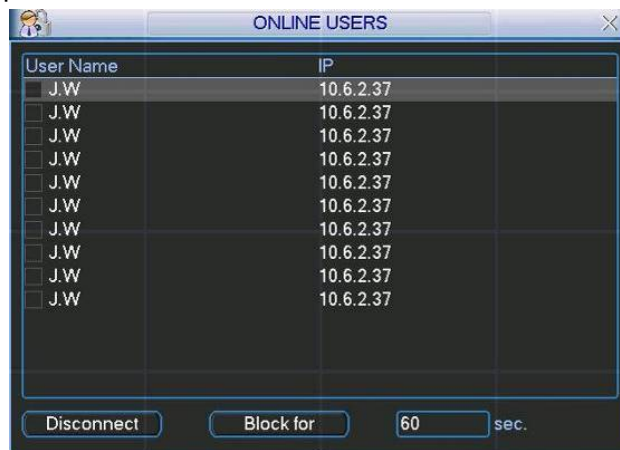

Figure 5-57

5.7 Shutdown

Double click shutdown button, system pops up a dialogue box for you to select. See Figure 5-58

- Logout menu user: log out menu. You need to input password when you login the next time.
- Restart application: reboot DVR.
- Shutdown: system shuts down and turns off power.
- Restart system: system begins rebooting.
- Switch user: you can use another account to log in.

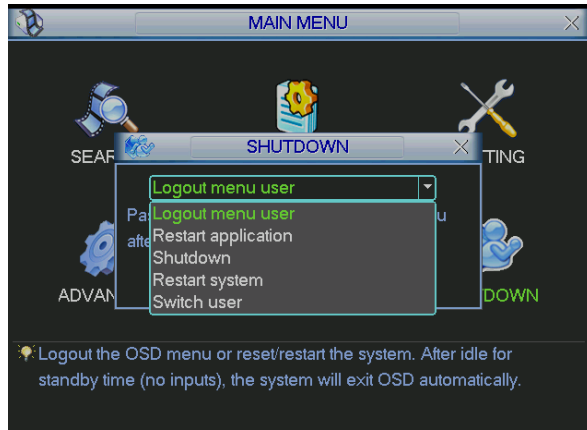

Figure 5-58

6 About Auxiliary Menu

6.1 Go to Pan/Tilt/Zoom Menu

In the one-window surveillance mode, right click mouse (click “fn” Button in the front panel or click AUX key in the remote control). The interface is shown as below: See Figure 6-1.

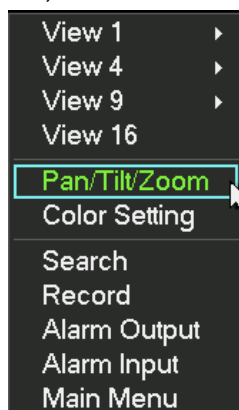

Figure 6-1

Click Pan/Tilt/Zoom, the interface is shown as in Figure 6-2.

Here you can set the following items:

- Zoom
- Focus
- Iris

Please click icon  and  to adjust zoom, focus and Iris.



Figure 6-2

In Figure 6-2, please click direction arrows (See Figure 6-3) to adjust PTZ position. There are totally eight direction arrows. (Please note there are only four direction arrows in DVR front panel.)



Figure 6-3

6.1.1 3D Intelligent Positioning Key

In the middle of the eight direction arrows, there is a 3D intelligent positioning key. See

Figure 6-4 . Please make sure your protocol supports this function and you need to use mouse to control.

Click this button, system goes back to the single screen mode. Drag the mouse in the screen to adjust section size.



Figure 6-4

Here is a sheet for you reference.

Name	Function key	function	Shortcut key	Function key	function	Shortcut key
Zoom		Near			Far	
Focus		Near			Far	
Iris		close			Open	

6.2 Preset /Patrol / Pattern /Border Function

In Figure 6-2 click the set button. The interface is shown as below:

Here you can set the following items:

- Preset
- Patrol
- Pattern
- Border



Figure 6-5

In Figure 6-2, click page switch button, you can see an interface as in Figure 6-6.

Here you can activate the following functions:

- Preset
- Tour(Patrol)
- Pattern
- Auto scan
- Auto pan
- Flip
- Page Switch

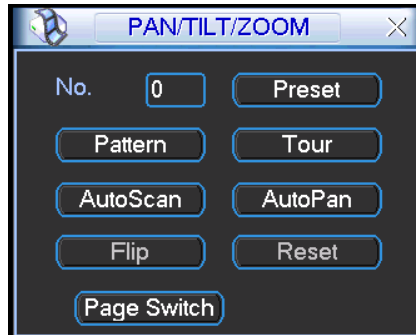

Figure 6-6

6.2.1 Preset Setup

Note: The following setups are usually operated in the Figure 6-2, Figure 6-5 and Figure 6-6.

In Figure 6-2, use eight direction arrows to adjust camera to the proper position.

In Figure 6-5, click preset button and input preset number. The interface is shown as in Figure 6-7.

Add this preset to one patrol number



Figure 6-7

6.2.2 Activate Preset

In Figure 6-6 please input preset number in the No. blank, and click preset button.

6.2.3 Patrol Setup

In Figure 6-5, click patrol button. The interface is shown as in Figure 6-8.

Input preset number and then add this preset to one patrol.



Figure 6-8

6.2.4 Activate Patrol

In Figure 6-6, input patrol number in the No. blank and click patrol button

6.2.5 Pattern Setup

In Figure 6-5, click pattern button and then click begin button. The interface shows like Figure 6-9.

Please go to Figure 6-2 to modify zoom, focus, and iris. Go back to Figure 6-9 and click end button.

You can memorize all these setups as pattern 1.



Figure 6-9

6.2.6 Activate Pattern Function

In Figure 6-6 input mode value in the No. blank, and click pattern button.

6.2.7 Border Setup

In Figure 6-5, click border button. The interface is shown as in Figure 6-10.

Please go to Figure 6-2, use direction arrows to select camera left limit, and then please go to Figure 6-10 and click left limit button

Repeat the above procedures to set right limit.



Figure 6-10

6.2.8 Activate Border Function

In Figure 6-6, click auto scan button, the system begins auto scan. Correspondingly, the auto scan button changes to stop button.

Click stop button to terminate scan operation.

6.2.9 Flip

In Figure 6-6, click page switch button, you can see an interface is shown as below. See Figure 6-11. Here you can set auxiliary function.

Click page switch button again, system goes back to Figure 6-2.

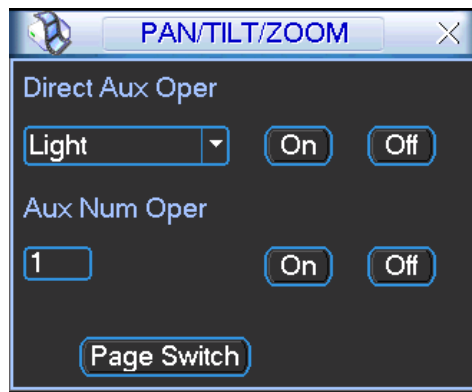

Figure 6-11

7 WEB CLIENT OPERATION

There might be slightly difference in the interface due to different series.

7.1 Network Connection

Before web client operation, please check the following items:

- Network connection is right
- DVR and PC network setup is right. Please refer to network setup(main menu->setting->network)
- Use order ping `***.***.***.***`(* DVR IP address) to check connection is OK or not. Usually the return TTL value should be less than 255.
- Open the IE and then input DVR IP address.
- System can automatically download latest web control and the new version can overwrite the previous one.
- If you want to un-install the web control, please run `uninstall webrec2.0.bat`. Or you can go to `C:\Program Files\webrec` to remove single folder. Please note, before you un-install, please close all web pages, otherwise the un-installation might result in error.

7.2 Login

Open IE and input DVR address in the address column. For example, if your DVR IP is 10.10.3.16, then please input `http:// 10.10.3.16` in IE address column. See Figure 7-1

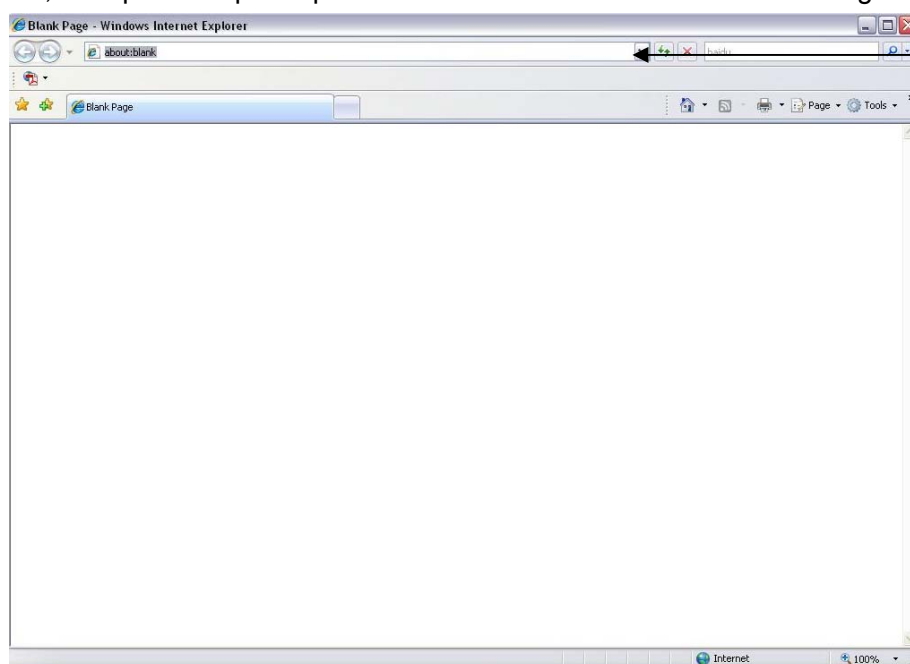

Figure 7-1

System pops up warning information to ask you whether install webrec.cab control or not. Please click yes button.

If you can't download the ActiveX file, please modify your settings as follows. See Figure 7-2.

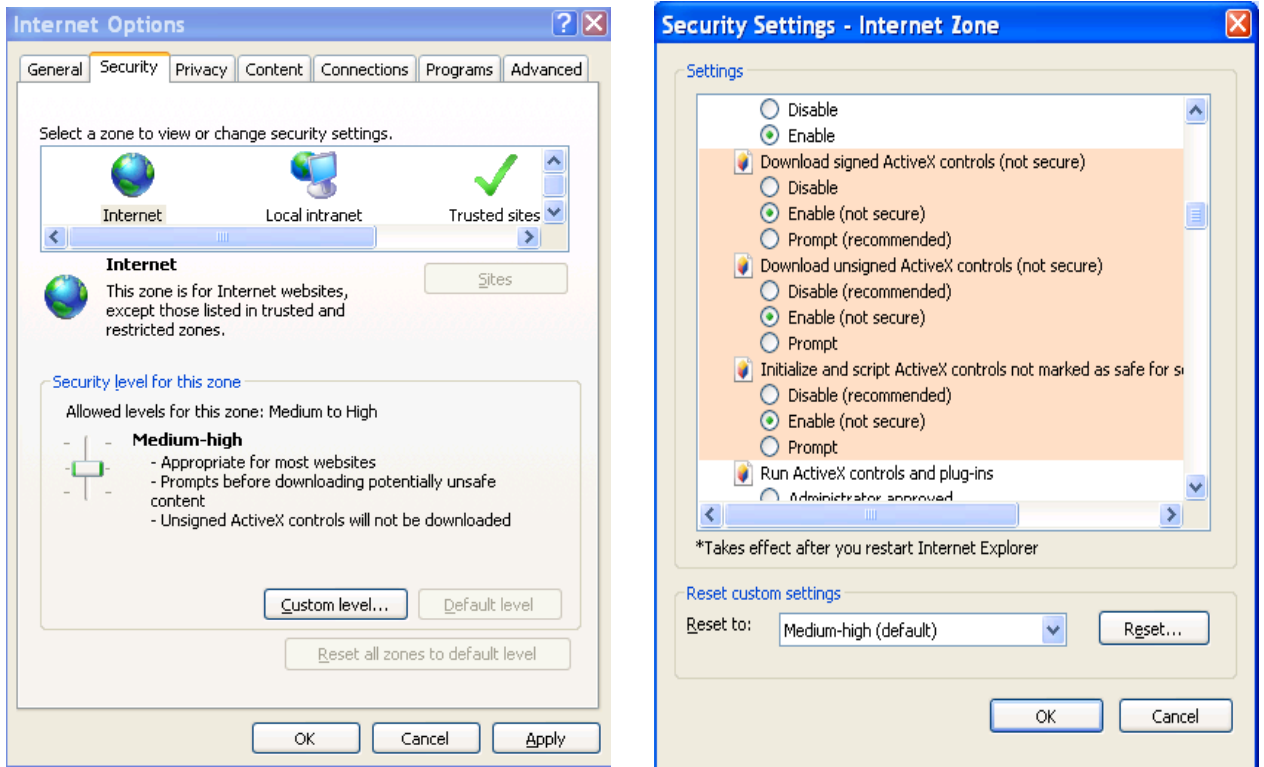

Figure 7-2

After installation, the interface is shown as below. See Figure 7-3.

Please input your user name and password.

Default factory name is admin and password is admin.

Note: For security reasons, please modify your password after you first login.

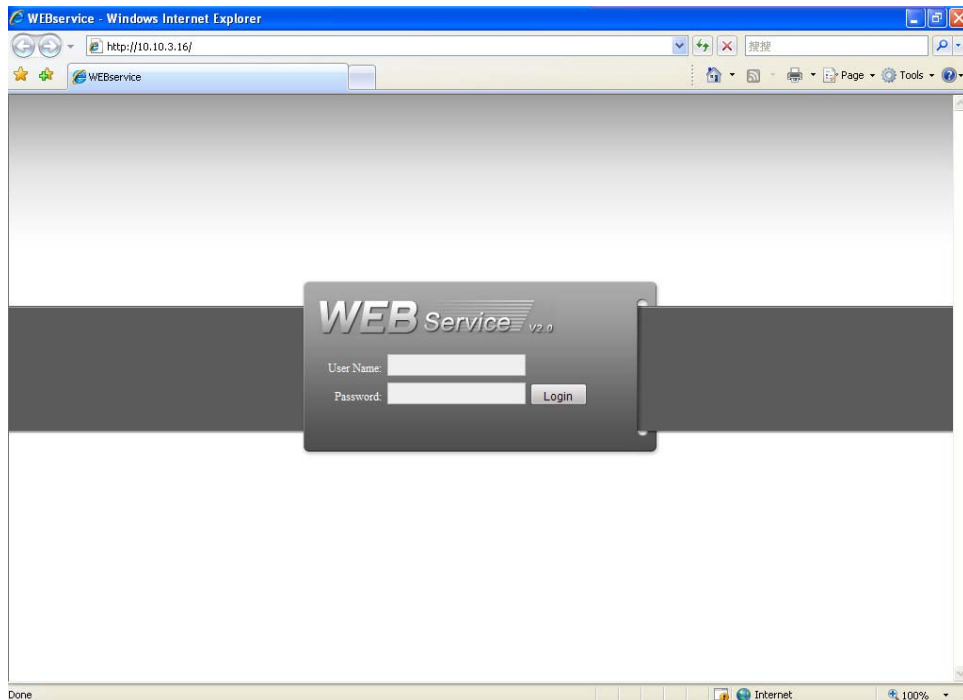

Figure 7-3

After you logged in, you can see the main window. See Figure 7-6.

This main window can be divided into the following sections.

- Section 1: there are five function buttons: configuration (chapter 7.3), search (chapter 7.4), alarm (chapter 7.5), about (chapter 7.6), log out (chapter 7.7).
- Section 2: there are channel number and three function buttons: start dialog and local play, refresh.
- Section 3: there are PTZ (chapter 7.2.2), color (chapter 7.2.3) button and you can also select picture path and record path.
- Section 4: real-time monitor window. Please note current preview window is circled by a green rectangle zone.
- Section 5: Here you can view window switch button. You can also select video priority between fluency or real-time.
 - ✧ System monitor window switch supports full screen/1-window/4-window/6-window/8-window/9-window/13-window/16-window/20-window/25-window/36-window. See Figure 7-4.



Figure 7-4

- ✧ Preview window switch. System support 1/4/8/9/16-window real-time preview. Please you need to have the proper rights to implement preview operation. You can not preview if you have no right to preview the either channel. See Figure 7-5. Please note this series device does not support this function.



Figure 7-5

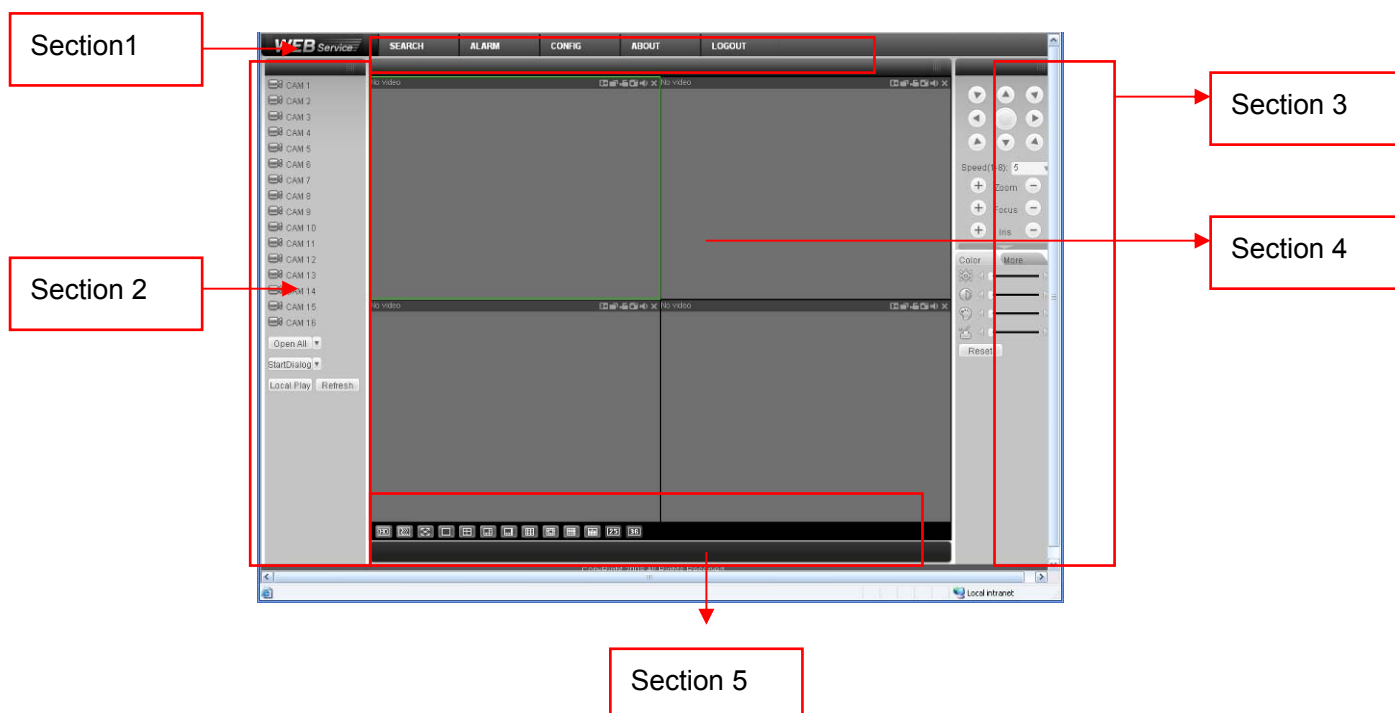

Figure 7-6

7.2.1 Real-time Monitor

In section 2, left click the channel name you want to view, you can see the corresponding video in current window.

On the top left corner, you can view device IP, channel number, network monitor bit stream.

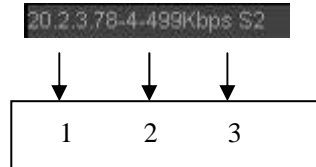

Figure 7-7

On the top right corner, there are six function buttons. See Figure 7-8.

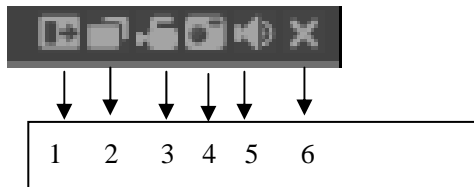

Figure 7-8

- 1: Digital zoom: Click this button and then left drag the mouse in the zone to zoom in. right click mouse system restores original status.
- 2: Change show mode: resize or switch to full screen mode.
- 3: Local record. When you click local record button, the system begins recording and this button becomes highlighted. You can go to system folder RecordDownload to view the recorded file.
- 4: Capture picture. You can snapshot important video. All images are memorized in system client folder \download\picture (default).
- 5: Audio :Turn on or off audio.(It has no relationship with system audio setup)
- 6: Close video.

Please refer to Figure 7-9 for main stream and extra stream switch information.



Figure 7-9

Open All

You can click it to open all channels.

Refresh

You can use button to refresh camera list.

Start Dialogue

You can click this button to enable audio talk. Click 【▼】 to select bidirectional talk mode. There are two options: DEFAULT/G711a.

Please note, the audio input port from the device to the client-end is using the first channel audio input port. During the bidirectional talk process, system will not encode the audio data from the 1-channel.

Local Play

The Web can playback the saved (Extension name is dav) files in the PC-end. Click local play button, system pops up the following interface for you to select local play

file. See Figure 7-10.



Figure 7-10

7.2.2 PTZ

Before PTZ operation, please make sure you have properly set PTZ protocol. (Please refer to chapter 7.3.2 Setting-> Pan/Tilt/Zoom).

Click PTZ button, the interface is shown as in Figure 7-11.

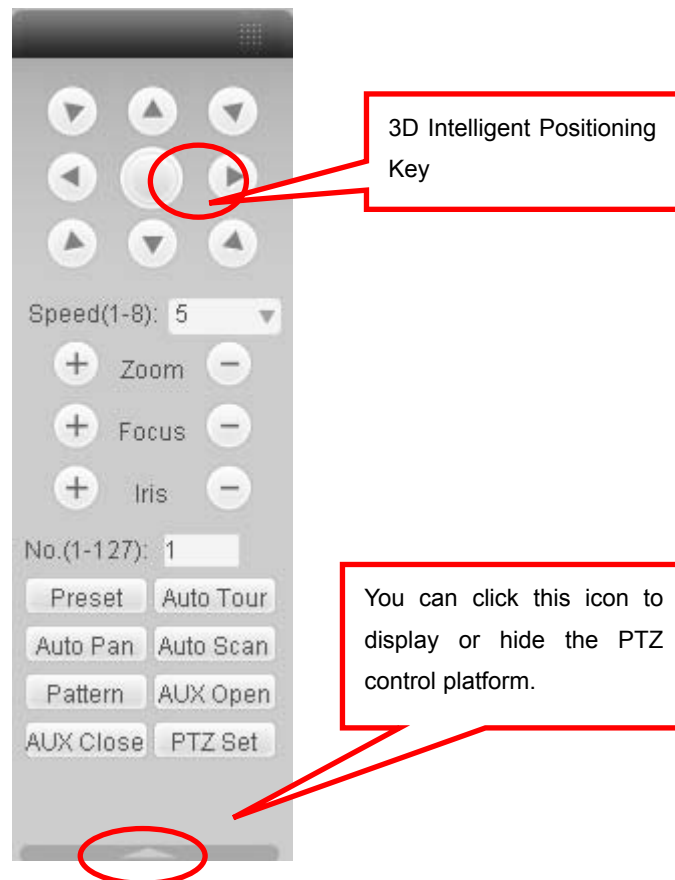

Figure 7-11

7.2.2.1 Direction key and 3D positioning key

In Figure 7-10, there are eight direction keys.

In the middle of the eight direction keys, there is a 3D intelligent positioning key.







Click 3D intelligent positioning key, system goes back to the single screen mode. Drag the mouse in the screen to adjust section size. It can realize PTZ automatically.

7.2.2.2 Speed

System supports eight-level speed. You can select from the dropdown list. Speed 2 is faster than speed 1.

7.2.2.3 Zoom/Focus/Iris

Here is a sheet for you reference.

Name	Function key	Function	Function key	Function
Zoom		Near		Far
Focus		Near		Far
Iris		close		Open

In Figure 7-11, click PTZ setup button you can see the following interface. See Figure 7-12.

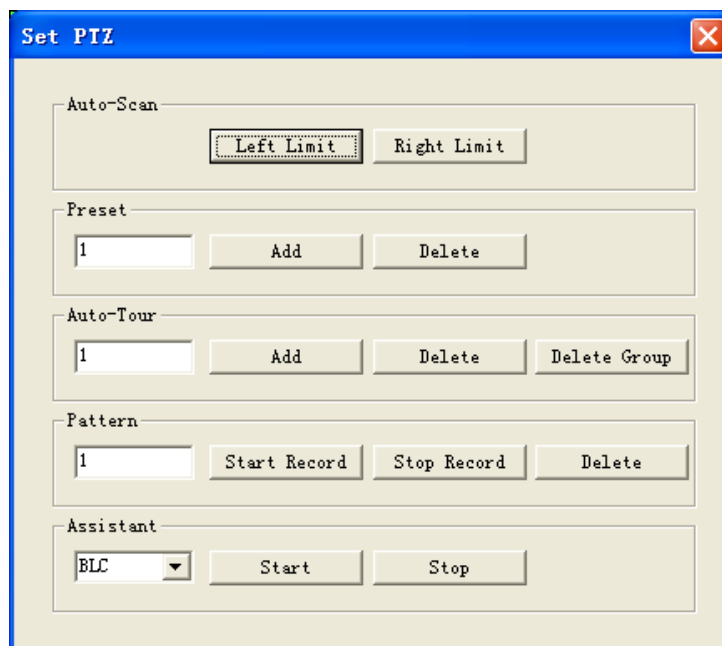

Figure 7-12

7.2.2.4 Auto Scan

In Figure 7-12, move the camera to you desired location and then click left limit button.

Then move the camera again and then click right limit button to set a right limit.

7.2.2.5 Pattern

In Figure 7-12, you can input pattern value and then click start record button to begin PTZ movement. Please go back to Figure 7-11 to implement camera operation. Then you can

click stop record button. Now you have set one pattern.

7.2.2.6 Preset

In Figure 7-12, move the camera to your desired location and then input preset value. Click add button, you have set one preset.

7.2.2.7 Auto tour

In Figure 7-12, input auto tour value and preset value. Click add button, you have added one preset in the tour.

Repeat the above procedures you can add more presets in one tour.

7.2.2.8 Assistant

You can select the assistant item from the dropdown list. See Figure 7-13.

7.2.2.9 Matrix

This series product supports matrix extension function. You can control the video input and output switch

7.2.2.10 Light and wiper

If your PTZ protocol supports the light and wiper control function. You can enable/disable the light or the wiper.

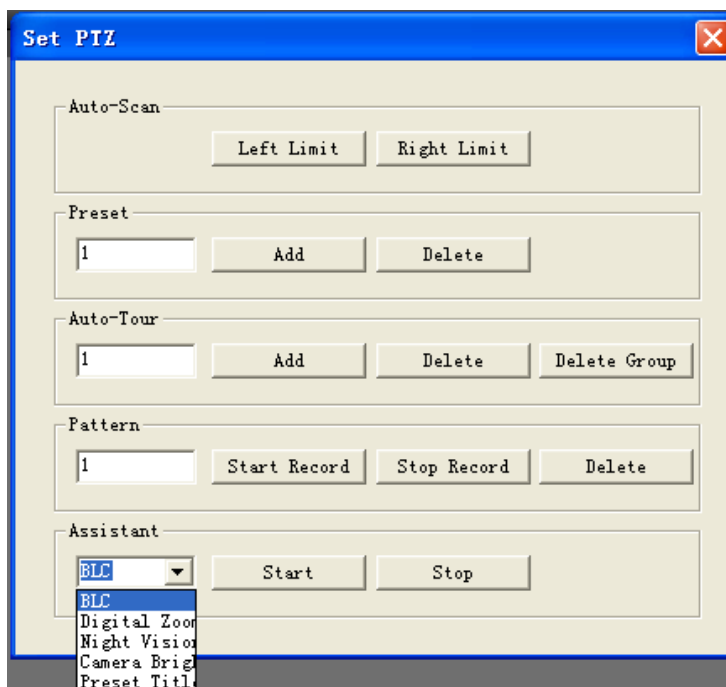

Figure 7-13

7.2.3 Color

Click color button in section 3, the interface is shown as Figure 7-14.

Here you can select one channel and then adjust its brightness, contrast, hue and saturation. (Current channel border becomes green).

Or you can click default button to use system default setup.

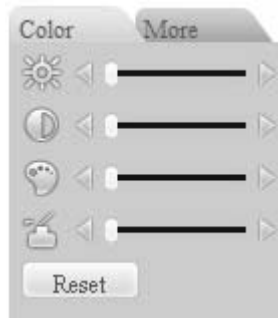

Figure 7-14

7.2.4 Picture Path and Record Path

Click more button in Figure 7-14, you can see an interface is shown as in Figure 7-15.

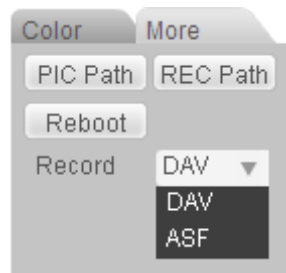

Figure 7-15

Click the record item; you can see there are two options: DAV/ASF.

Click picture path button, you can see an interface is shown as in Figure 7-16.

Please click choose button to modify path.

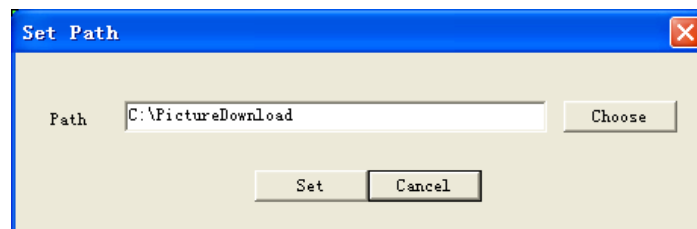

Figure 7-16

Click record path button, you can see an interface is shown as in Figure 7-17.

Please click choose button to modify path.

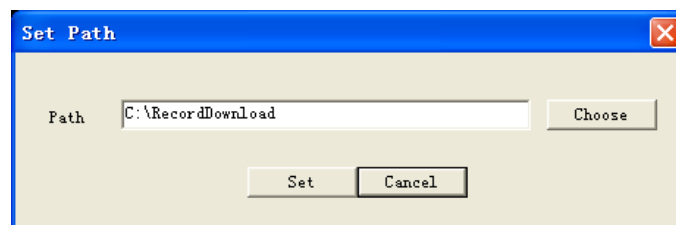

Figure 7-17

Click reboot button, system pops up the following dialogue box. See Figure 7-18,

Please click OK to reboot.

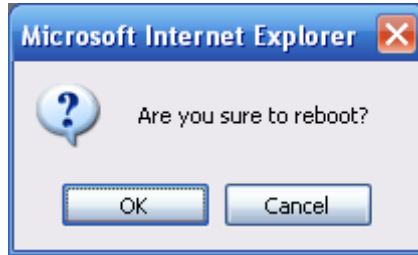

Figure 7-18

If there is local use logged in the system menu, or the Web logged in user has no right to reboot the device system pops up a dialogue box to alert you.

7.3 Configure

7.3.1 System Information

7.3.1.1 Version Information

Here you can view device hardware feature and software version information. See Figure 7-19.

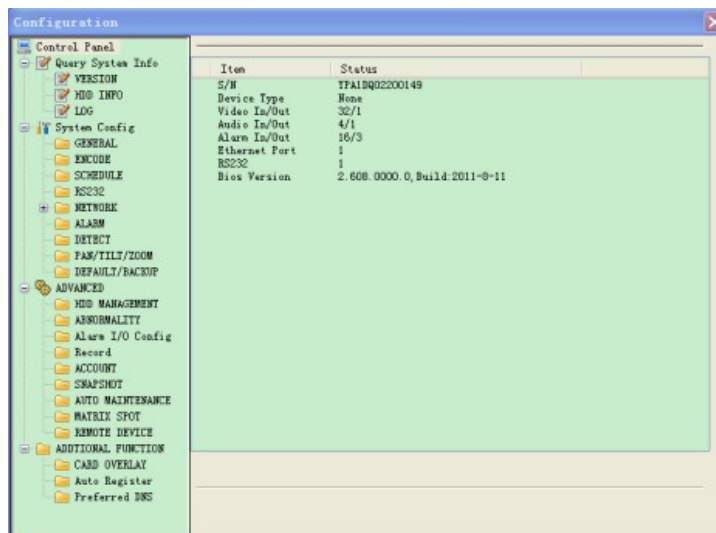

Figure 7-19

7.3.1.2 HDD information

Here you can view local storage status and network status including, free capacity and total capacity. See Figure 7-20.

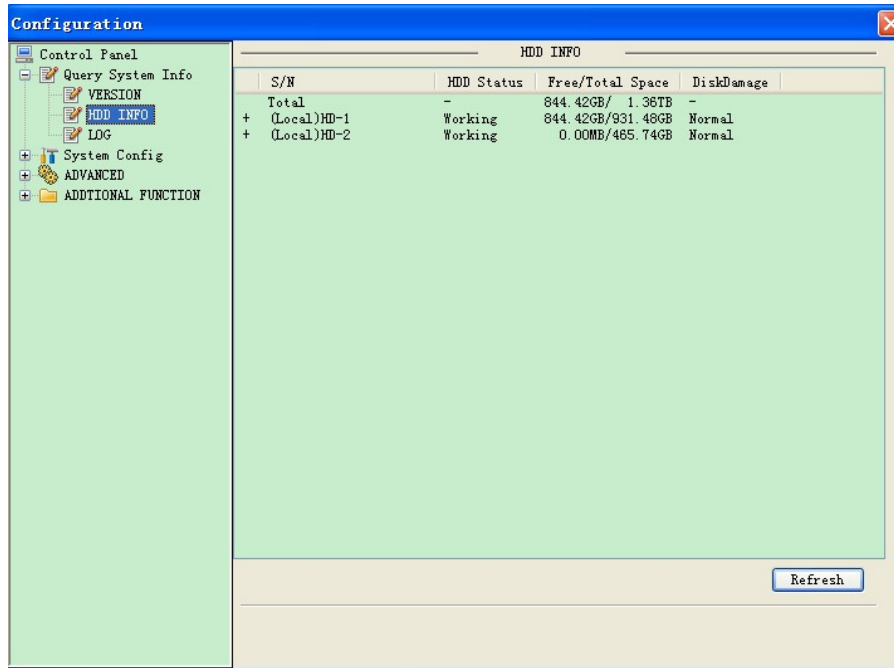

Figure 7-20

7.3.1.3 Log

Here you can view system log. See Figure 7-21.

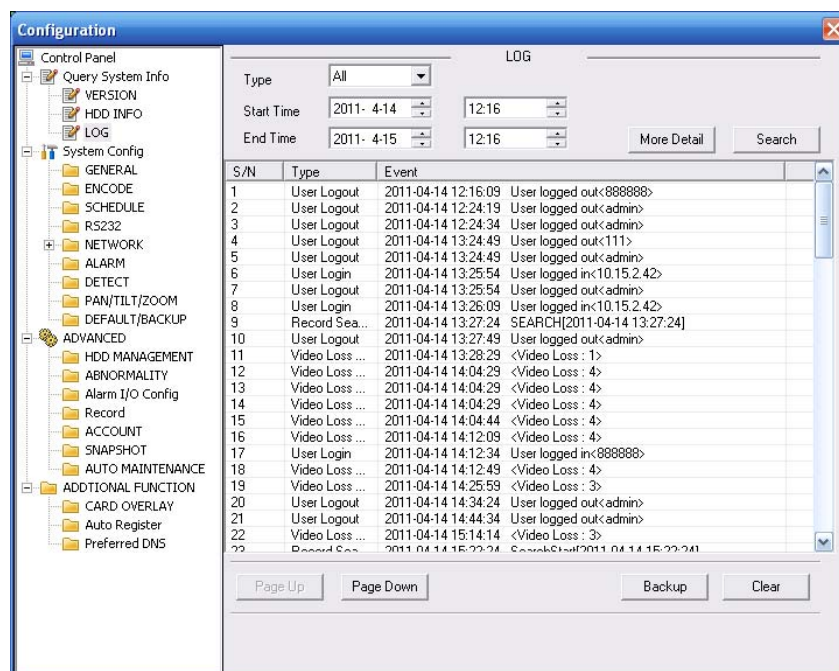

Figure 7-21

Click backup button, the interface is shown as in Figure 7-22.

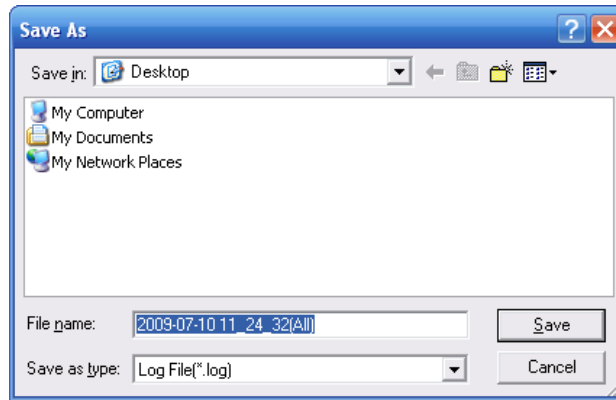

Figure 7-22

Please refer to the following sheet for log parameter information.

Parameter	Function
Type	Log types include: system operation, configuration operation, data management, alarm event, record operation, user management, log clear and file operation.
Search	You can select log type from the drop down list and then click search button to view the list.
Start time	Please input start time here.
End time	Please input the end time here.
Clear	You can click this button to delete all displayed log files. Please note system does not support clear by type.
More details	Select one item and click this button, you can view the detailed log information.
Backup	You can click this button to backup log files to current PC.

7.3.2 System Configuration

Please click save button to save your current setup.

7.3.2.1 General Setup

Here you can set system time, record length, video format and etc. See Figure 7-23

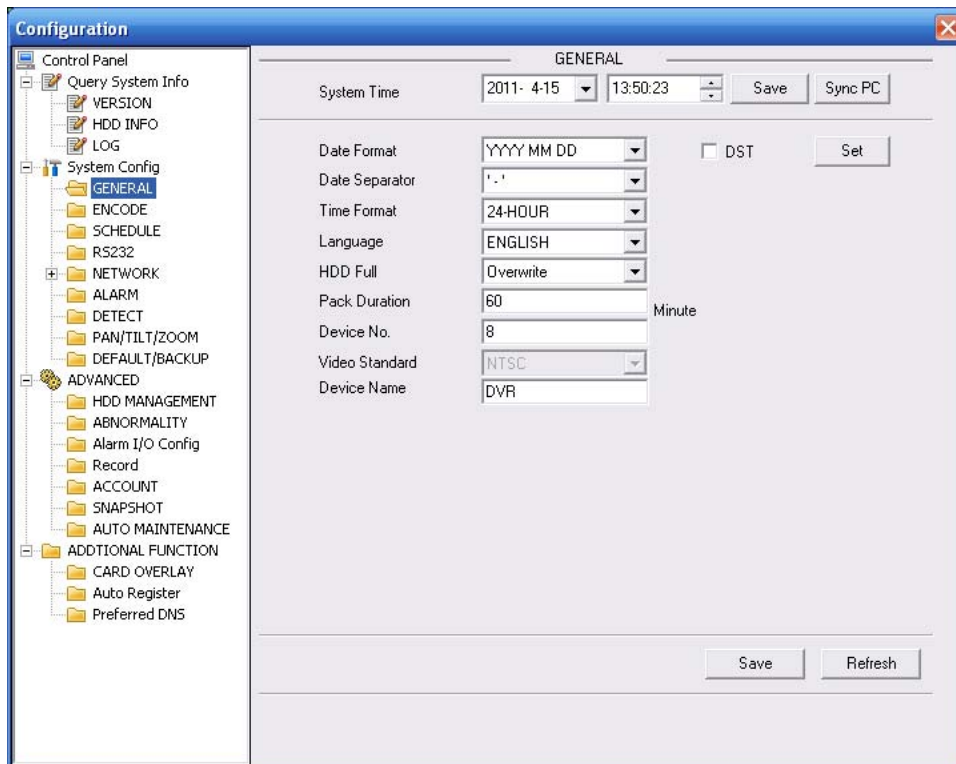

Figure 7-23

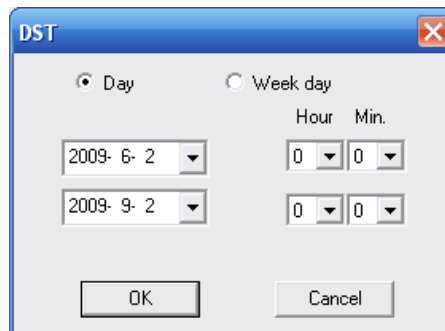

Figure 7-24

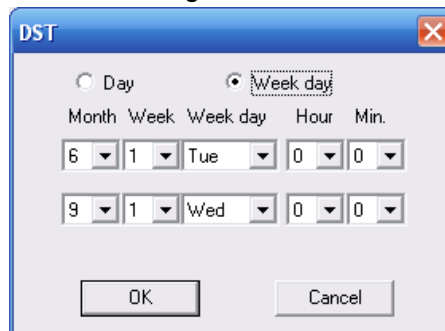

Figure 7-25

Please refer to the following sheet for detailed information.

Parameter	Function
System Time	Here is for you to modify system time. Please click Save button after your completed modification

Sync PC	You can click this button to save the system time as your PC current time.
Data Format	Here you can select data format from the dropdown list.
Data Separator	Please select separator such as – or /.
Time Format	There are two options: 24-H and 12-H.
<hr/>	
DST	Here you can set day night save time begin time and end time. See Figure 7-24 and Figure 7-25.
Language	You can select the language from the dropdown list. Device needs to reboot to get the modification activated.
HDD Full	There are two options: stop recording or overwrite the previous files when HDD is full. When current working HDD is overwriting or it is full now, system stops record. If current working HDD is full now, system goes to overwrite the previous file.
Pack Duration	Here you can select file size. The value ranges from 1 to 120. Default setup is 60 minutes.
Device No	When you are using one remote control (not included in the accessory bag) to manage multiple devices, you can give a serial numbers to the device.
Video Standard	There are two options: PAL/NTSC. Please note, for the Web user, this information is for reference only. You can not modify.
<hr/>	
Device Name	Please input the corresponding device name here.

7.3.2.2 Encode

Encode interface is shown as in Figure 7-26.



Figure 7-26

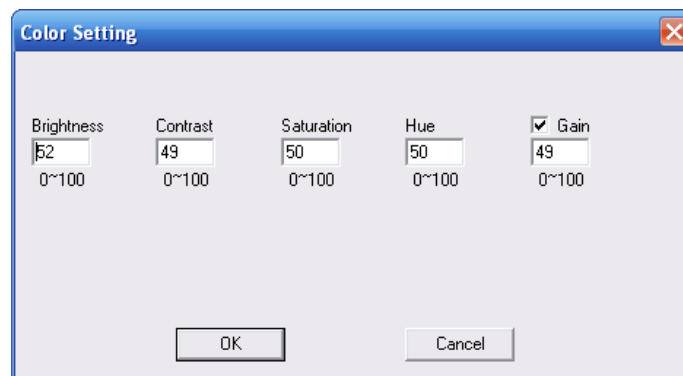

Figure 7-27

Please refer to the following sheet for detailed information.

Parameter	Function
Channel	Here is for you to select a monitor channel.
Channel Name	Here is to display current channel name. You can modify it.
Compression	H.264
Main Stream	It includes main stream, motion stream and alarm stream. You can select different encode frame rates form different recorded events. System supports active control frame function (ACF). It allows you to record in different frame rates. For example, you can use high frame rate to record important events, record scheduled event in lower frame rate and it allows you to set different frame rates for motion detection record and alarm record.
Extra Stream	Select extra stream if you enabled the extension stream to monitor.
Audio/Video	For the main stream, recorded file only contains video by default. You

Parameter	Function
	<p>need to draw a circle here to enable audio function.</p> <p>For extra stream, you need to draw a circle to select the video first and then select the audio if necessary.</p>
Resolution	<p>System supports various resolutions, you can select from the dropdown list.</p> <p>The main stream supports D1/HD1/2CIF/CIF/QCIF and the 1-16 channel extra stream supports CIF/QCIF.</p> <p>Please note the option may vary due to different series.</p>
Frame Rate	PAL: 1~25f/s; NTSC: 1~30f/s.
Bit Rate Type	<p>There are two options: VBR and CBR.</p> <p>Please note, you can set video quality in VBR mode only.</p>
Quality	The value ranges from 1 to 6. The level 6 is the best video quality.
Bit Rate	<ul style="list-style-type: none"> ✦ In CBR, the bit rate here is the max value. In dynamic video, system needs to low frame rate or video quality to guarantee the value. ✦ The value is null in VBR mode. ✦ Please refer to recommend bit rate for the detailed information.
Recommended Bit	Recommended bit rate value according to the resolution and frame rate you have set.
Color Setting	<p>Here you can set video brightness, contrast ness, hue, saturation and gain.</p> <p>The value ranges from 0 to 100.Default value is 50. See Figure 7-27.</p> <p>Please note, some series devices do not support OSD transparent setup function.</p>
Cover area (privacy mask)	<ul style="list-style-type: none"> ✦ Here you can privacy mask the specified video in the monitor video. ✦ One channel max supports 4 privacy mask zones. ✦ The privacy mask includes two options: Never/monitor. Never: It means do not enable privacy mask function. Monitor: the privacy mask zone can not be viewed in monitor mode.
Time Title	<ul style="list-style-type: none"> ✦ You can enable this function so that system overlays time information in video window. ✦ OSD transparent value ranges from 0 to 255. 0 means complete transparent. Please note OSD transparent setup is form special series only. ✦ You can use the mouse to drag the time tile position.
Channel Title	<ul style="list-style-type: none"> ✦ You can enable this function so that system overlays channel information in video window. ✦ OSD transparent value ranges from 0 to 255. 0 means complete transparent. ✦ You can use the mouse to drag the channel tile position.
Copy	It is a shortcut menu button. You can copy current channel setup to one or more channels. The interface is shown as in Figure 7-28.

Parameter	Function
Save	You can click save button after you complete setup for one channel, or you can complete the whole setups and then click save button.
Refresh	Click this button to get device latest configuration information.

Click copy interface, the interface is shown as in Figure 7-28.

If you have completed the setup for channel 1, you can click 3 to copy current setup to channel 3. Or you can click 2, 3, and 4 to copy current setup to channel 2, channel 3 and channel 4.

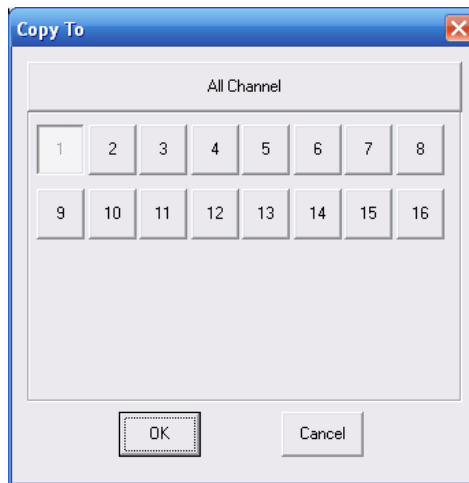

Figure 7-28

7.3.2.3 Schedule

Here you can set different periods for various days. There are max six periods in one day. See Figure 7-29

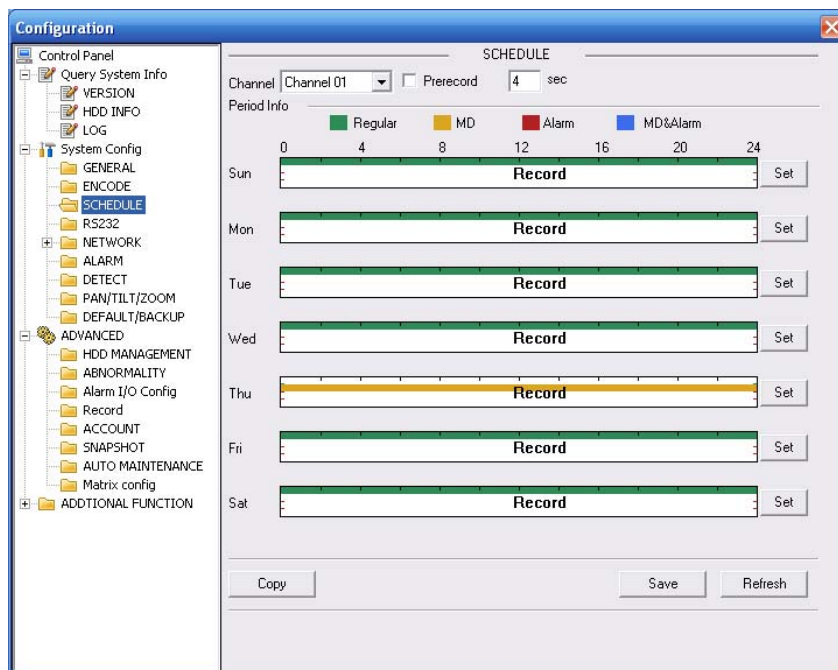

Figure 7-29

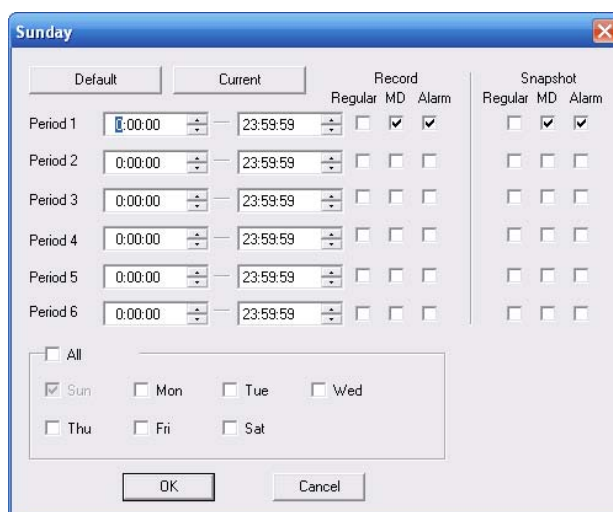

Figure 7-30

Please refer to the following sheet for detailed information.

Parameter	Function
Channel	Please select a channel first.
Pre-record	Please input pre-record value here. System can record the three to five seconds video before activating the record operation into the file. (Depends on data size).

Setup	<ul style="list-style-type: none"> ✦ In Figure 7-29, click set button, you can go to the corresponding setup interface. ✦ Please set schedule period and then select corresponding record or snapshot type: schedule/snapshot, motion detection/snapshot, and alarm/snapshot. ✦ Please select date (Current setup applies to current day by default. You can draw a circle before the week to apply the setup to the whole week.) ✦ After complete setup, please go back to Figure 7-29 and then click save to save current time period setup.
Copy	It is a shortcut menu button. You can copy current channel setup to one or more (all) channels. The interface is shown as in Figure 7-28.
Save	You can click save button after you complete setup for one channel, or you can complete the whole setups and then click save button.
Refresh	Click this button to get device latest configuration information.

7.3.2.4 RS232

The RS232 interface is shown as in Figure 7-31.

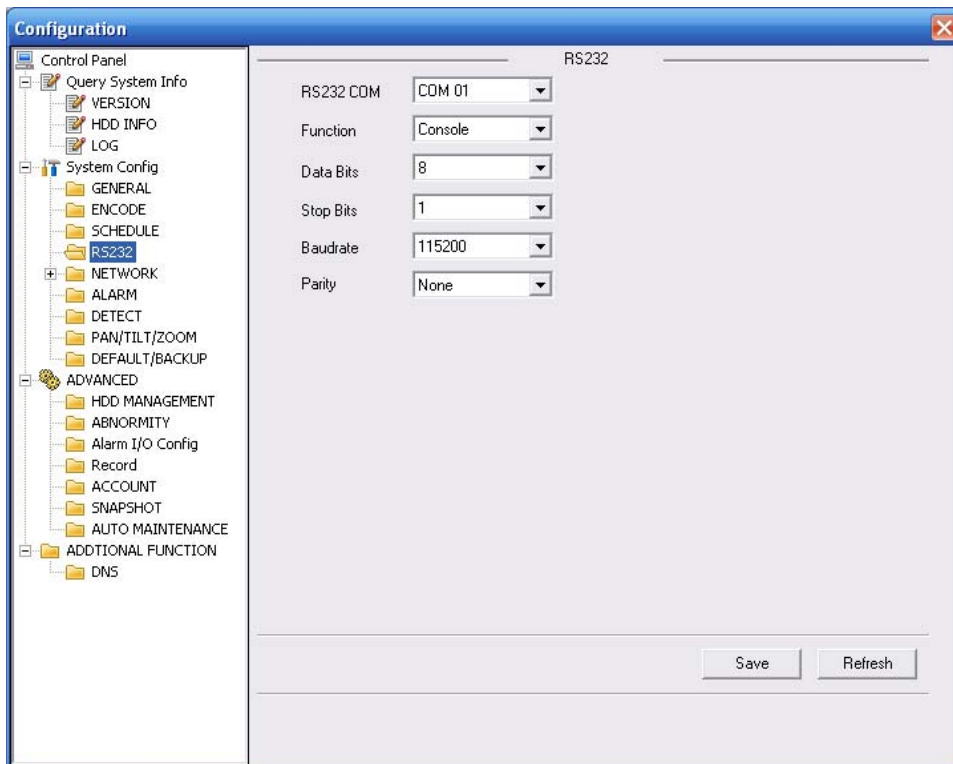

Figure 7-31

Please refer to the following sheet for detailed information.

Parameter	Function
RS232	There are two options: COM 01 and keyboard.
Function	Console is to upgrade the program or debug via COM or mini terminal software. Keyboard: COM control protocol. You can use keyboard to control DVR via COM.
Data Bit	The value ranges from 5 to 8.
Stop Bit	There are three options: 1/2.
Baud Bit	You can select corresponding baud bit here.
Parity	There are five options: none/odd/even/space/mark.

System default setup is:

- Function: Console.
- Data bit: 8
- Stop bit: 1
- Baud bit: 115200
- Parity: None.

7.3.2.5 Network

Network interface is shown as in Figure 7-32.

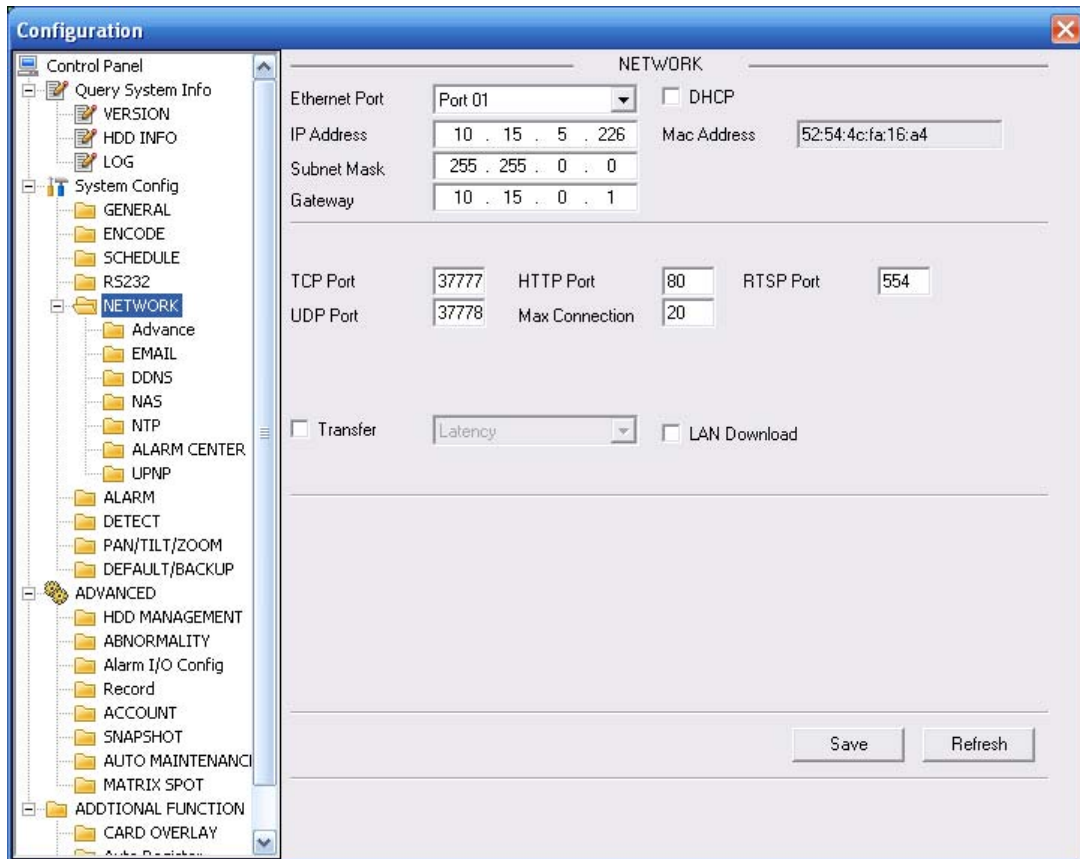

Figure 7-32

Please refer to the following sheet for detailed information.

Parameter	Function
Ethernet	Please select the network card first.
DHCP	Dynamically get IP address. You can get the device IP from the DHCP server if you enabled this function.
TCP Port	Default value is 37777.
HTTP Port	Default value is 80.
UDP Port	Default value is 37778.
RTSP Port	Default value is 554.
Max Connection	Network user max amount. The value ranges from 0 to 20. 0 means there is no user can access current device.
Remote Host	<ul style="list-style-type: none"> ✦ Multiple cast group ✦ Set MULCAST address and port. ✦ Enable MULCAST function.
PPPOE	<ul style="list-style-type: none"> ✦ Input the PPPoE user name and password you get from the IPS (internet service provider) and enable PPPoE function. Please save current setup and then reboot the device to get the setup activated. ✦ Device connects to the internet via PPPoE after reboot. You can get the IP address in the WAN from the IP address

Parameter Function

column.

- ✧ Please note if you want to reboot the device please make sure you have proper reboot right and there is no login user in current device.

Email

The email interface is shown as in Figure 7-33.

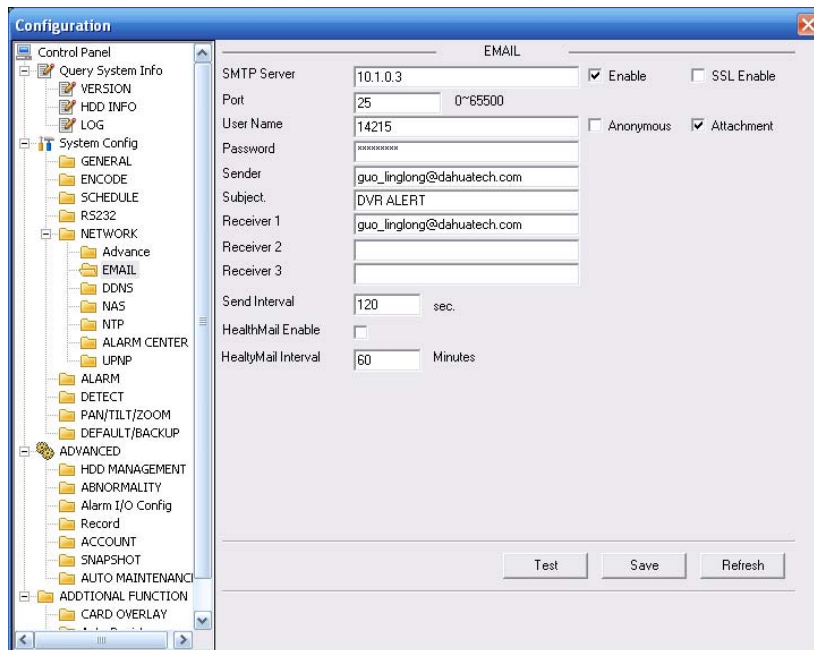

Figure 7-33

Please refer to the following sheet for detailed information.

Parameter	Function
SMTP Server	Input server address and then enable this function.
Port	Input port value here.
User Name	The sender email account user name.
Password	The sender email account password.
Sender	Sender email address.
Subject	Input email subject here. Max 32-digit.
Address	Input receiver email address here. Max input three addresses. Support SSL encryption mailbox.
Health mail enable	Please check the box here to enable this function. This function allows the system to send out the test email to check the connection is OK or not.
Health mail interval	Please check the above box to enable this function and then set the corresponding interval. System can send out the email regularly as you set here.

DDNS

The DDNS interface is shown as in Figure 7-34.

Please make sure your DVR support this function.

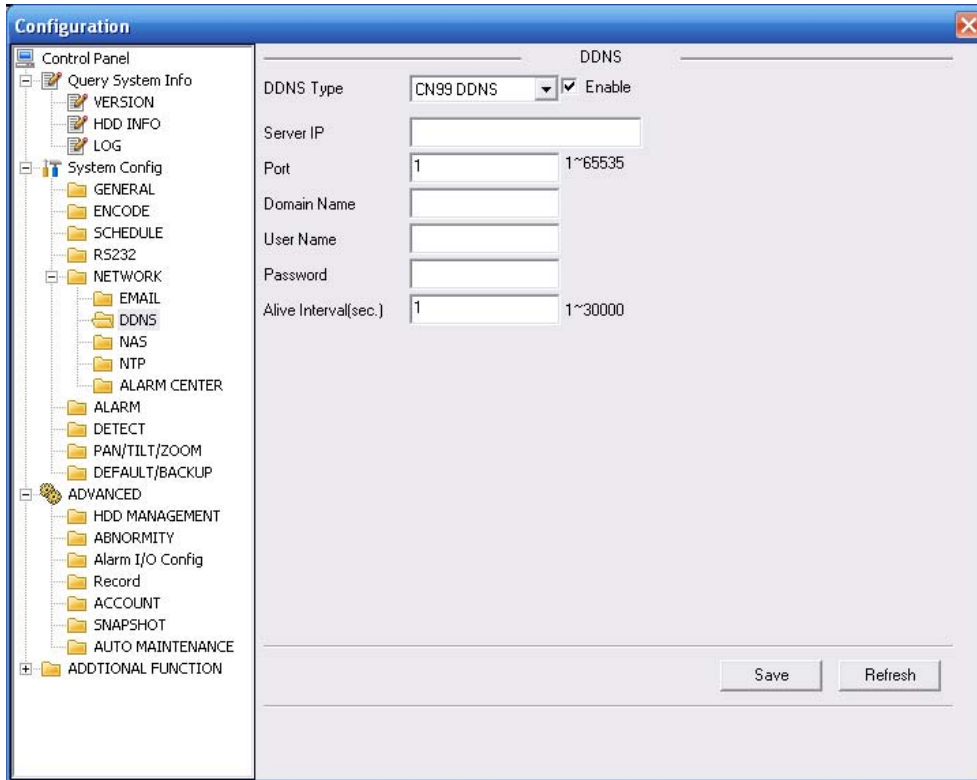

Figure 7-34

Please refer to the following sheet for detailed information.

Parameter	Function
Server Type	You can select DDNS protocol from the dropdown list and then enable DDNS function. The private DDNS protocol means you use your self-defined private protocol to realize DDNS function.
Server IP	DDNS server IP address
Server Port	DDNS server port.
Domain Name	Your self-defined domain name.
User	The user name you input to log in the server.
Password	The password you input to log in the server.
Interval	◇ Device sends out alive signal to the server regularly. ◇ You can set interval value between the device and DDNS server here.

NAS

NAS interface is shown as in Figure 7-35.

Please make sure your DVR support this function.

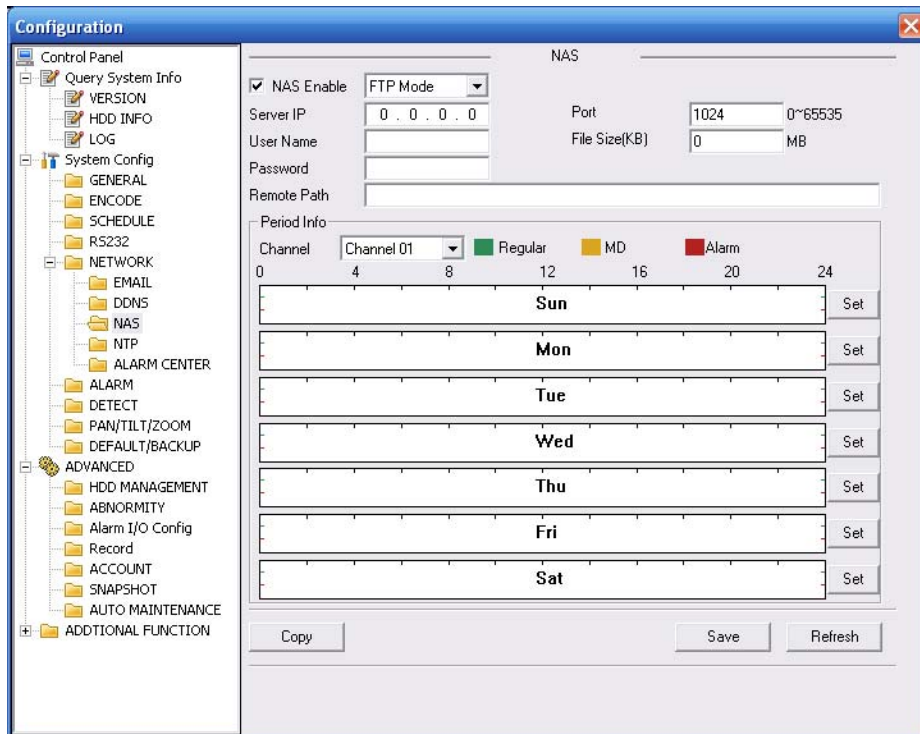

Figure 7-35

Please refer to the following sheet for detailed information.

Parameter	Function
NAS enable	Please select network storage protocol and then enable NAS function.
Server IP	Input remote storage server IP address.
Port	Input Remote storage server port number.
User Name	Log in user account.
File length	The file length you upload to the FTP. When setup is larger than the actual file length, system will upload the whole file. When setup here is smaller than the actual file length, system only uploads the set length and auto ignore the left section. When interval value is 0, system uploads all corresponding files.
Password	The password you need to log in the server.
Remote Path	Remote storage file path.
Save	You can click save button after you complete setup for one channel, or you can complete the whole setups and then click save button.
Refresh	Click this button to get device latest configuration information.

NTP

The NTP interface is shown as in Figure 7-36.

Here you can realize network time synchronization. Please enable current function and

then input server IP, port number, time zone and update interval. Please note the SNTP supports TCP transmission only and its port shall be 123. The update interval ranges from 1 to 65535. Default value is 10 minutes.

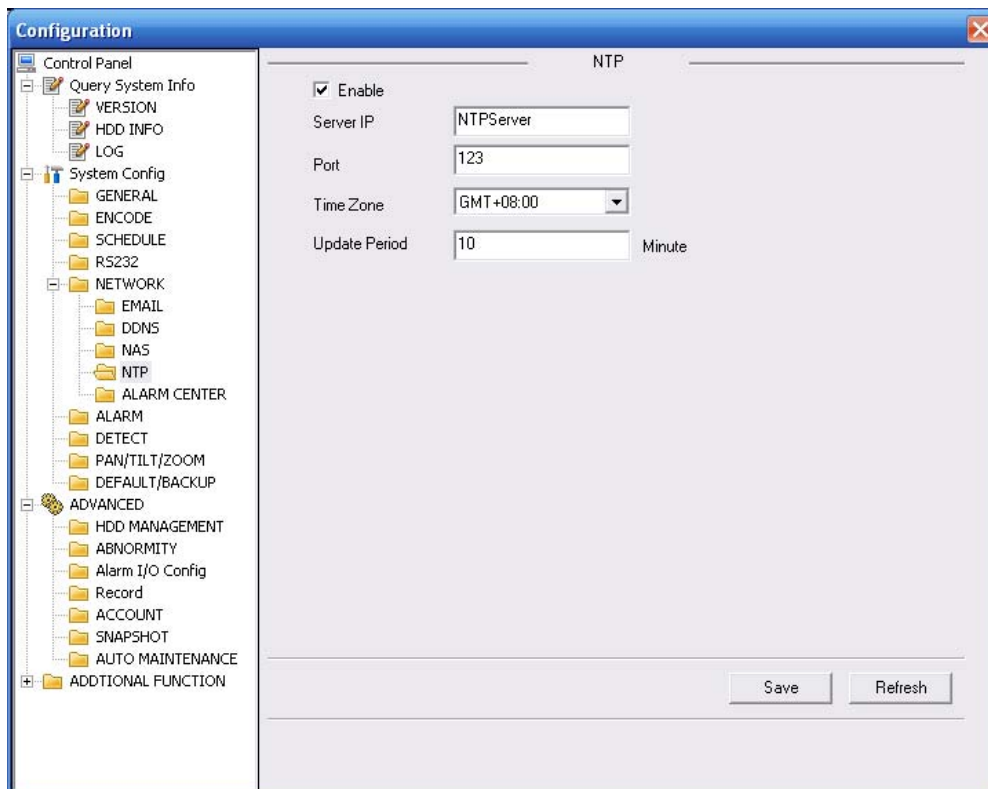

Figure 7-36

You can refer to the following sheet for time zone information.

City /Region Name	Time Zone
London	GMT+0
Berlin	GMT+1
Cairo	GMT+2
Moscow	GMT+3
New Deli	GMT+5
Bangkok	GMT+7
Beijing (Hong Kong)	GMT+8
Tokyo	GMT+9
Sydney	GMT+10
Hawaii	GMT-10
Alaska	GMT-9
Pacific Time(P.T)	GMT-8
American Mountain Time(M.T)	GMT-7
American Central Time(C.T)	GMT-6
American Eastern Time(E.T)	GMT-5
Atlantic Time	GMT-4
Brazil	GMT-3
Middle Atlantic Time	GMT-2

Alarm Centre

Alarm centre interface is shown as below. See Figure 7-37.

This interface is for you to develop. The alarm signal can be uploaded to the alarm centre when there is local alarm.

Please set the corresponding parameters such as server IP, port and etc.

The system can send out the data as the protocol defined to the client-end.

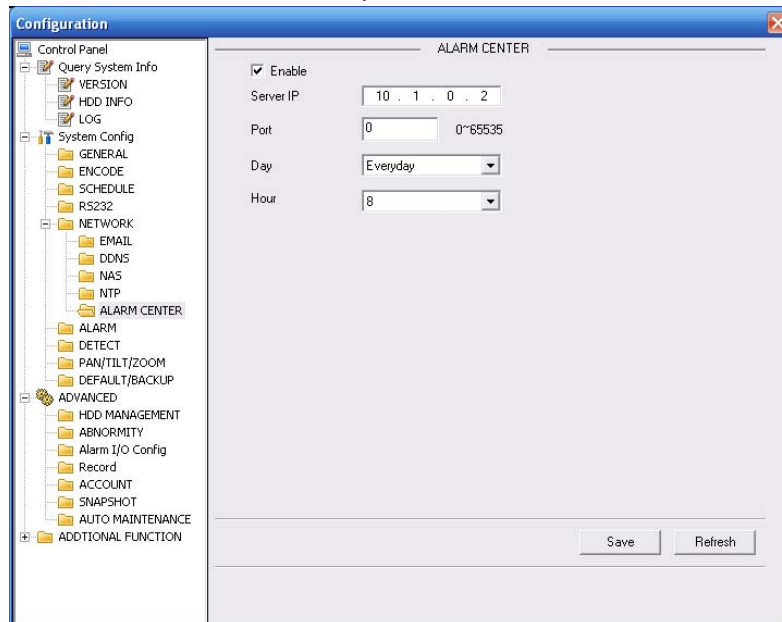

Figure 7-37

Advanced

The advanced interface is shown as in Figure 7-38.

◆ Multiple cast

Please refer to chapter 5.3.5.3 for detailed multiple cast setup information.

◆ PPPoE

Please input the PPPoE user name and password you get from the IPS (internet service provider) and enable PPPoE function. Please save current setup and then reboot the device to get the setup activated.

Device connects to the internet via PPPoE after reboot. You can get the IP address in the WAN from the IP address column.

Note:

After PPPoE successful dial, you need to go to the device local end to get device current IP address and then use the client-end to access this IP address.

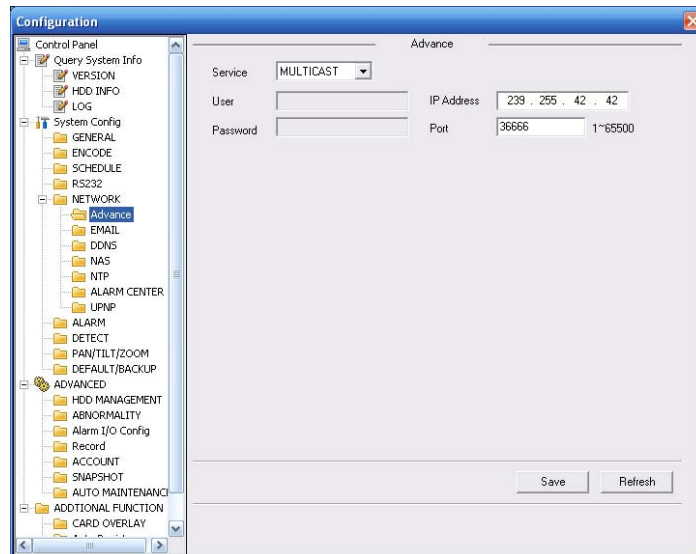

Figure 7-38

UNPN

Go to the UPnP interface, you can see an image is shown as in Figure 3-39.

It allows you to establish the mapping relationship between the LAN and the public network.

Here you can also add, modify or remove UPnP item.

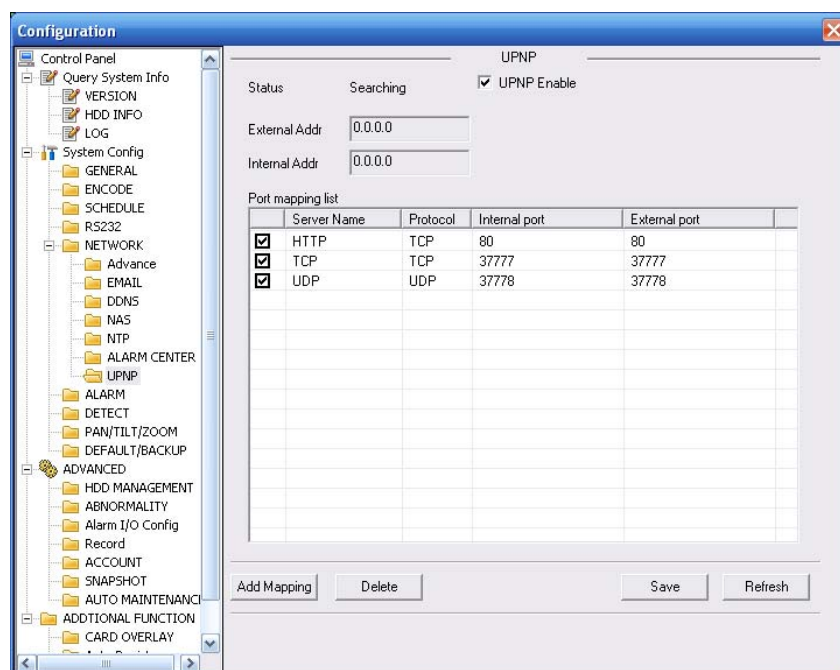

Figure 7-39 UNPN

7.3.2.6 Alarm

Alarm setup interface is shown as in Figure 7-40.

Please make sure you have connected the corresponding alarm output device such as the light, buzzer and etc.

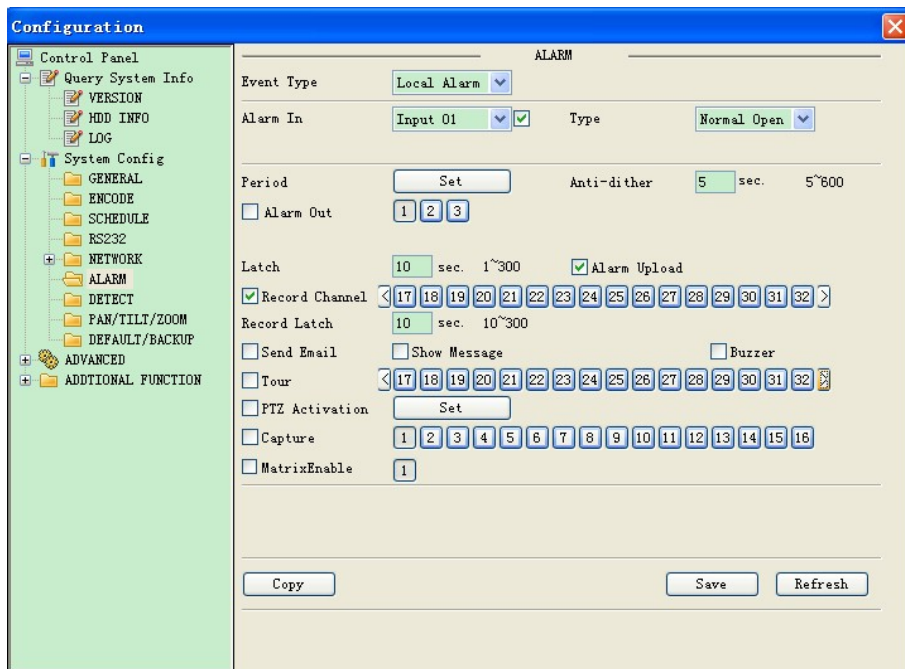

Figure 7-40

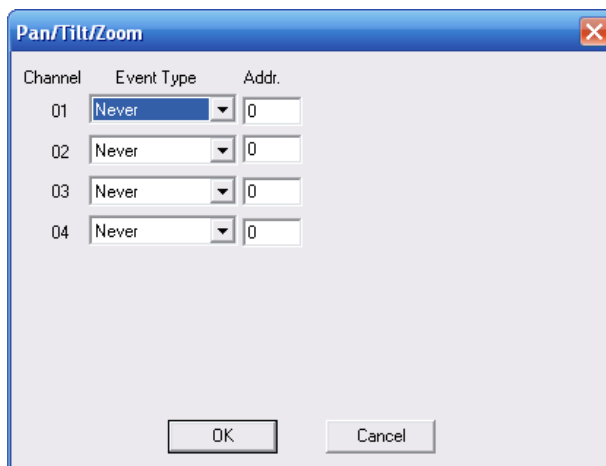

Figure 7-41

Please refer to the following sheet for detailed information.

Parameter	Function
Event Type	It includes local alarm/network alarm.
Type	Local alarm: Device detects alarm from input port. Network: Device detects alarm from network.
Alarm in	Select corresponding alarm channel.
Enable	You need to draw a circle here so that system can detect the alarm signal.
Type	There are two options: normal open and normal close. NO becomes activated in low voltage, NC becomes activated in high voltage.
Period	Alarm record function becomes activated in the specified periods.

Parameter	Function
	<p>There are six periods in one day. Please draw a circle to enable corresponding period.</p> <p>Select date. If you do not select, current setup applies to today only. You can select all week column to apply to the whole week.</p> <p>Click OK button, system goes back to alarm setup interface, please click save button to exit.</p>
Anti-dither	System only memorizes one event during the anti-dither period. The value ranges from 3 to 600s.
Normal Out	Enable alarm activation function. You need to select alarm output port so that system can activate corresponding alarm device when alarm occurred.
Alarm Latch	System can delay the alarm output for specified time after alarm ended. The value ranges from 1 second to 300 seconds.
Show message	System pops up the alarm messages in the monitor interface.
Buzzer	Once you check the box here, the buzzer beeps when an alarm occurred.
Alarm upload	System can upload the alarm signal to the centre (Including alarm centre).
Record Channel	System auto activates current channel to record once alarm occurs (working with alarm activation function). Please note current device shall be in auto record mode (Chapter 4.4 Schedule).
Record Latch	System can delay the record for specified time after alarm ended. The value ranges from 10s to 300s.
Email	Please draw a circle to enable email function. System can send out email to alert you when alarm occurs and ends.
Tour	<p>Display the selected video in local monitor window.</p> <p>Tour interval and tour mode are set in DVR local menu (chapter 5.3.9 Display)</p>
PTZ activation	<p>Here you can set PTZ movement when alarm occurs. Such as go to preset x when there is an alarm.</p> <p>The PTZ configuration events include preset, tour, and pattern.</p>
Capture	You need to input capture channel number so that system can backup snapshot file when alarm occurs.
Copy	It is a shortcut menu button. You can copy current channel setup to one or more (all) channels.
Save	You can click save button after you complete setup for one channel, or you can complete the whole setups and then click save button.
Refresh	Click this button to get device latest configuration information.

7.3.2.7 Detect

Analysis the video, system enable motion detection alarm when it detects the motion

signal reached the specified sensitivity.
 The detection interface is shown as in Figure 7-42.

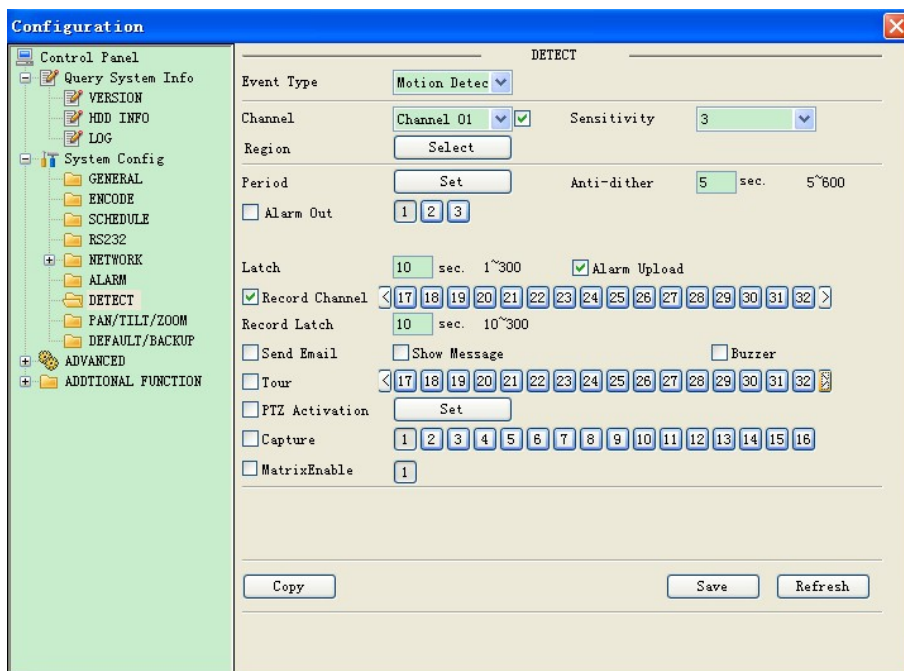

Figure 7-42

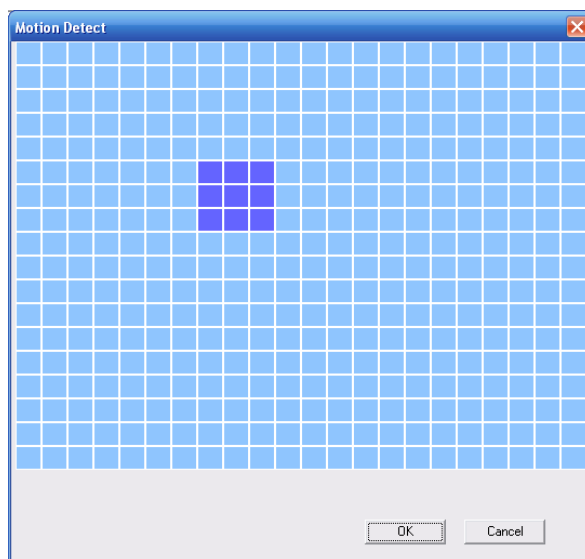

Figure 7-43

Please refer to the following sheet for detailed information.

Parameter	Function
Event Type	There are three types: Motion detection/video loss/Camera Masking.
Channel	Select channel name from the dropdown list.
Enable	You need to draw a circle to enable motion detection function.

Parameter	Function
Sensitivity	There are six levels. The sixth level has the highest sensitivity.
Region	<ul style="list-style-type: none"> ✧ There are six levels. The sixth level has the highest sensitivity. ✧ Region: If you select motion detection type, you can click this button to set motion detection zone. The interface is shown as in Figure 7-43. There are PAL 22X18/NTSC 22X15 zones. Right click mouse you can go to full-screen display mode. Do remember clicking OK button to save your motion detection zone setup.
Period	<ul style="list-style-type: none"> ✧ Motion detection function becomes activated in the specified periods. ✧ There are six periods in one day. Please draw a circle to enable corresponding period. ✧ Select date. If you do not select, current setup applies to today only. You can select all week column to apply to the whole week. ✧ Click OK button, system goes back to motion detection interface; please click save button to exit.
Anti-dither	System only memorizes one event during the anti-dither period. The value ranges from 3s to 600s.
Normal out	<ul style="list-style-type: none"> ✧ There is 2-channel alarm output. ✧ Corresponding to motion detection alarm output port(multiple choices) ✧ Enable alarm activation function. You need to select alarm output port so that system can activate corresponding alarm device when alarm occurs.
Alarm latch	System can delay the alarm output for specified time after alarm end. The value ranges from 1s to 300s.
Show message	System pops up the alarm messages in the monitor interface.
Buzzer	Once you check the box here, the buzzer beeps when an alarm occurred.
Alarm upload	System can upload the alarm signal to the centre (Including alarm centre).
Record channel	System auto activates motion detection channel (multiple choices) to record once alarm occurs (working with motion detection function). Please note you need to go to Chapter 4.4 Schedule to set motion detection record period and go to chapter 4.2 Manual Record to set current period as auto record.
Record latch	System can delay the record for specified time after alarm ended. The value ranges from 10s to 300s.
Email	If you enabled this function, System can send out email to alert you when alarm occurs and ends.
Tour	<ul style="list-style-type: none"> ✧ Display the selected video in local monitor window. ✧ Tour interval and tour mode are set in DVR local menu (chapter 5.3.9 Display)
PTZ	✧ Here you can set PTZ movement when alarm occurs. Such as go to

Parameter	Function
Activation	preset x when there is an alarm.
Capture	You need to input capture channel number so that system can backup motion detection snapshot file.
Matrix Enable	Please note this function is valid in motion detect mode. Check the box here to enable video matrix function. Right now system supports one-channel tour function. System takes “first come and first serve” principle to deal with the activated tour. System will process the new tour when a new alarm occurs after previous alarm ended. Otherwise it restores the previous output status before the alarm activation.
Copy	It is a shortcut menu button. You can copy current channel setup to one or more (all) channels.
Save	You can click save button after you complete setup for one channel, or you can complete the whole setups and then click save button.
Refresh	Click this button to get device latest configuration information.

7.3.2.8 PTZ

PTZ interface is shown as in Figure 7-44.

Please note, before operation please make sure you have set speed dome address. And DVR and speed dome connection is OK.

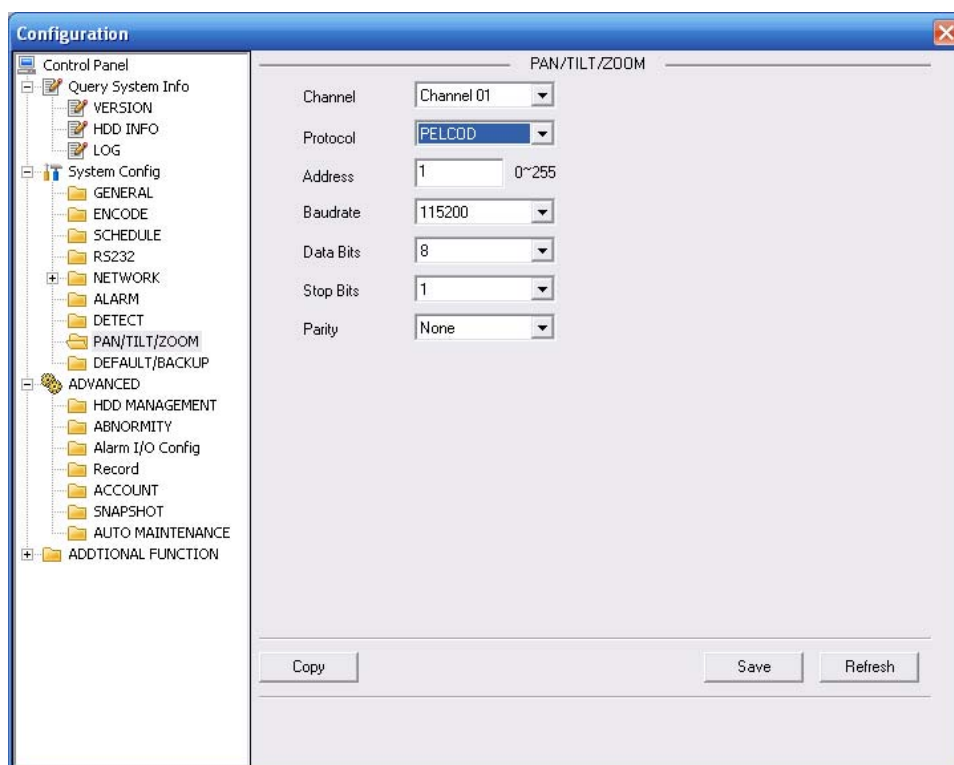

Figure 7-44

Please refer to the following sheet for detailed information.

Parameter	Function
Channel	You can select monitor channel from the dropdown list. .

Parameter	Function
Protocol	Select the corresponding dome protocol.(such as PELCOD)
Address	Set corresponding dome address. Default value is 1. Please note your setup here shall comply with your dome address; otherwise you can not control the speed dome.
Baud Rate	Select the dome baud rate. Default setup is 9600.
Data Bit	Default setup is 8. Please set according to the speed dome dial switch setup.
Stop bit	Default setup is 1. Please set according to the speed dome dial switch setup.
Parity	Default setup is none. Please set according to the speed dome dial switch setup.
Save	You can click save button after you complete setup for one channel, or you can complete the whole setups and then click save button.
Refresh	Click this button to get device latest configuration information.

7.3.2.9 Default & Backup

Default: Restore factory default setup. You can select corresponding items.

Backup: Export current configuration to local PC or import configuration from current PC.

Please refer to Figure 7-45.

Please note system can not restore some information such as network IP address.

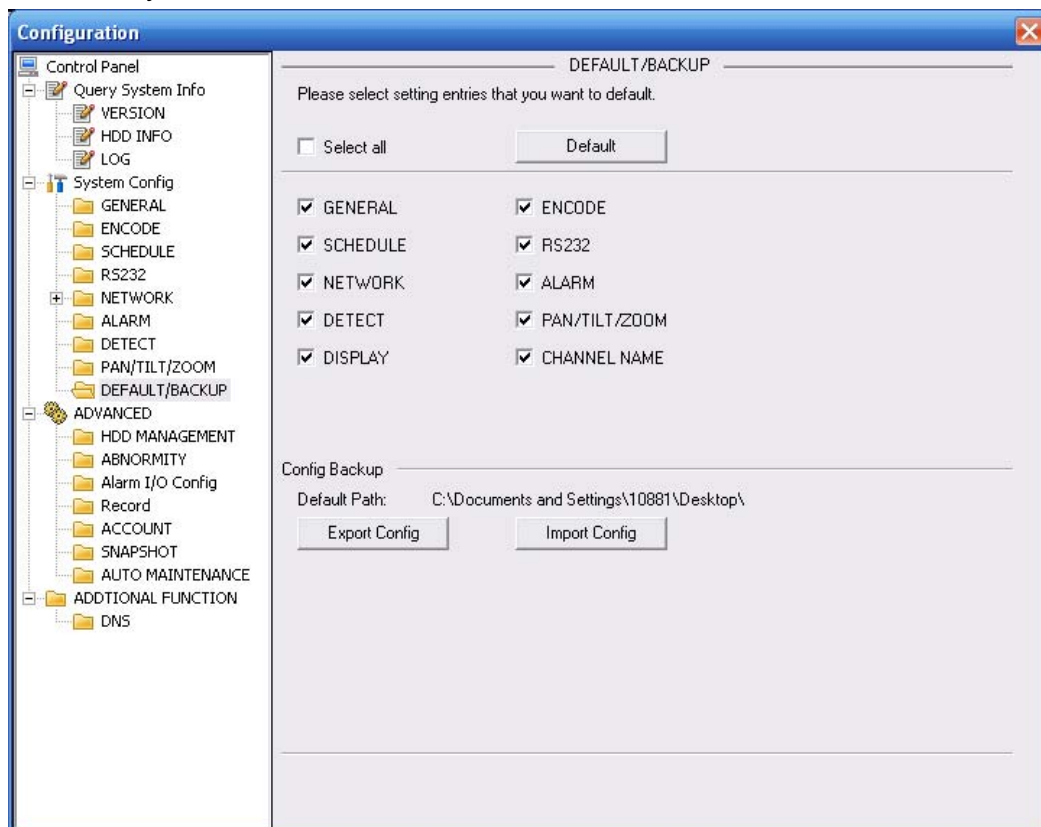

Figure 7-45

Please refer to the following sheet for detailed information.

Parameter	Function
Select All	Restore factory default setup.
Export Configuration	Export system configuration to local PC.
Import Configuration	Import configuration from PC to the system.

7.3.3 Advanced

7.3.3.1 HDD Management

HDD management includes net storage management and local storage management.

Please note, if you want to use local storage function, your storage device need to support current function.

Please select the storage device first and then you can see the items on your right become valid. You can check the corresponding item here. See Figure 7-46.

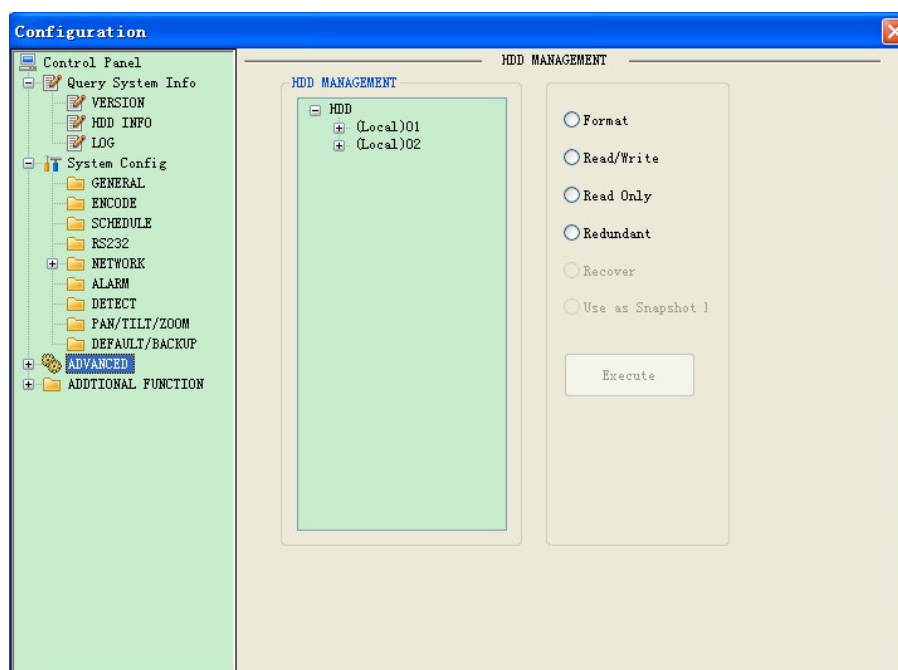

Figure 7-46

Please refer to the following sheet for detailed information.

Parameter	Function
Format	Clear data in the disk.
Read/write	Set current disk as read/write
Read only	Set current disk as read.
Redundant	Set current disk as redundant disk.
Recover	Recover dada after error occurs.

Parameter	Function
Use as snapshot	Set current disk as snapshot disk.

Please note system needs to reboot to activate current setup.

7.3.3.2 Alarm I/O

Here you can search alarm output status. See Figure 7-47.

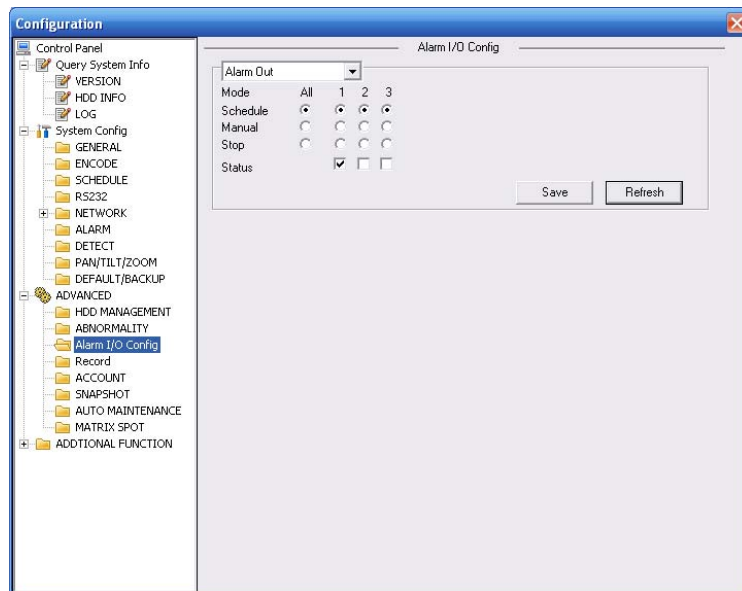

Figure 7-47

Important

The alarm output port should not be connected to high power load directly (It shall be less than 1A) to avoid high current which may result in relay damage. Please use the contactor to realize the connection between the alarm output port and the load.

Please refer to the following sheet for detailed information.

Parameter	Function
Alarm output	There are three output channels (Multiple choices). Please note the displayed alarm output channel amount here may vary due to the different series.
Activate	Enable/disable alarm output device. After the Web activated the alarm, you need to cancel the channel and then click the activation button to cancel the alarm, or you need to cancel the alarm in the pop-up dialogue box in local-end.
Refresh	Search alarm output status.

7.3.3.3 Record

Record control interface is shown as in Figure 7-48.

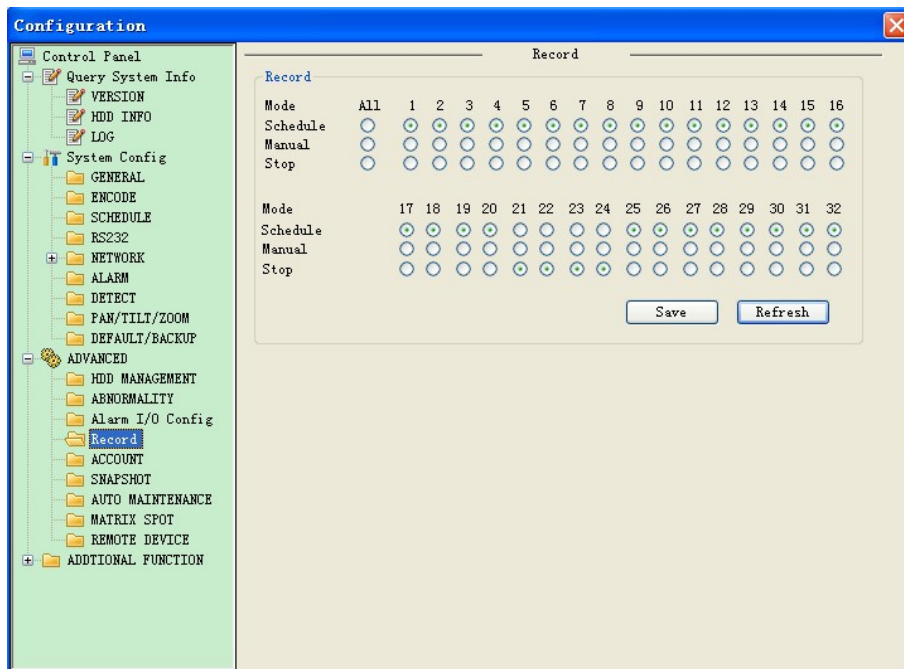

Figure 7-48

Please refer to the following sheet for detailed information.

Parameter	Function
Auto	System enables auto record function as you set in record schedule setup.
Manual	Enable corresponding channel to record no matter what period applied in the record setup.
Stop	Stop current channel record no matter what period applied in the record setup.

Operation here is the same to chapter 4.2 Manual Record. Please refer to chapter 4.2 for detailed information.

7.3.3.4 Account

Here you can add, remove user or modify password. See Figure 7-49.

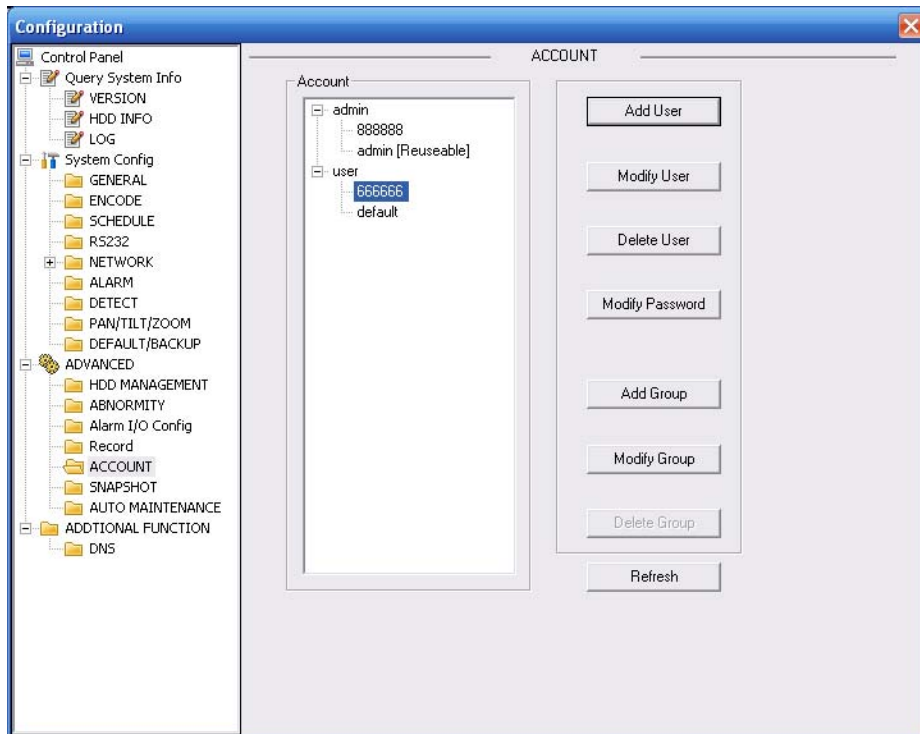

Figure 7-49

7.3.3.5 Auto Maintenance

Here you can select auto reboot and auto delete old files interval from the dropdown list. See Figure 7-50.

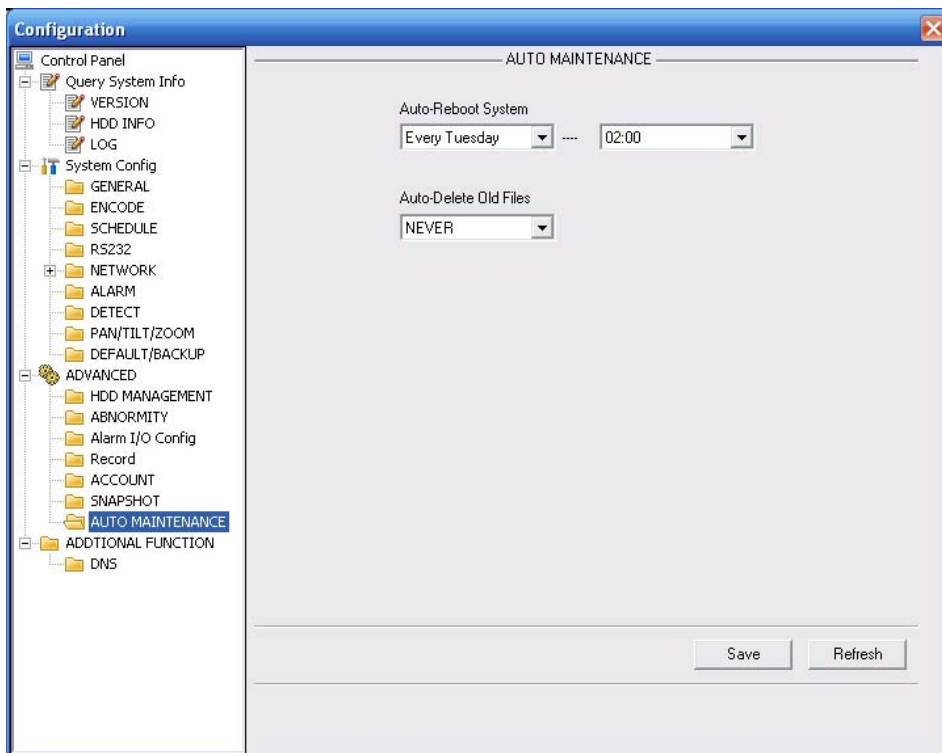

Figure 7-50

7.3.3.6 Snapshot

Snapshot interface is shown as in Figure 7-51.

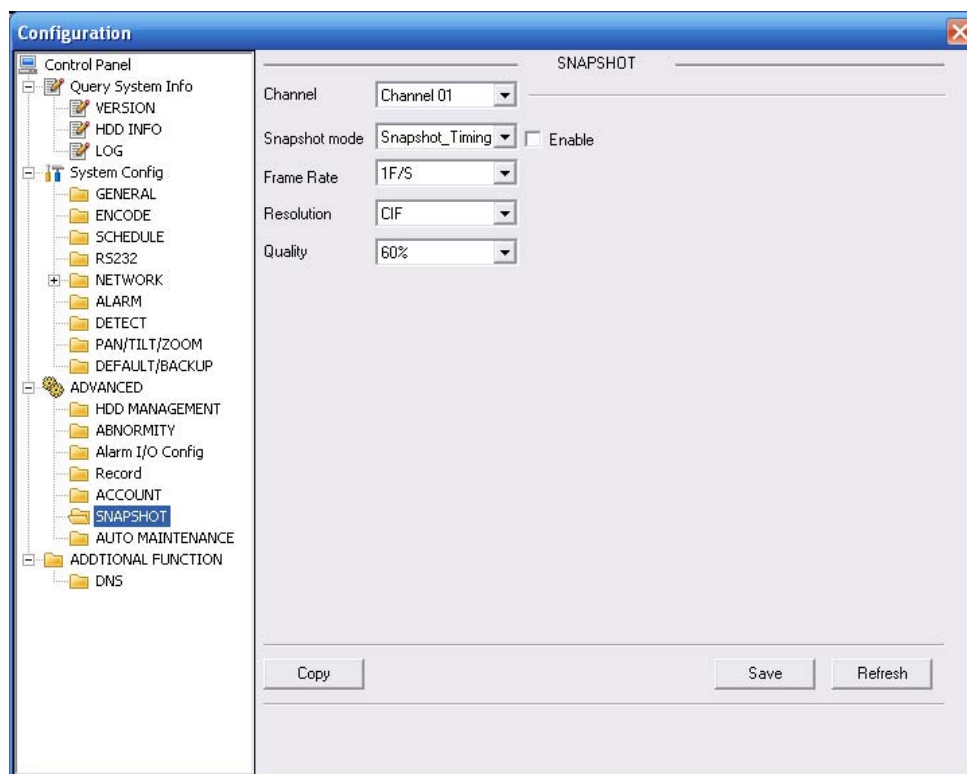

Figure 7-51

Please refer to the following sheet for detailed information.

Parameter	Function
Channel	It is the monitor channel.
Snapshot mode	There are two modes: Timing and activation.
Frame rate	You can select from the dropdown list. The value ranges from 1f/s to 7f/s.
Resolution	different choices for different models.
Quality	You can select from the dropdown list. Here is for you to set video quality. There are six options: 10%, 30%, 50%, 60%, 80%, 100%. 100% is the best quality.

7.3.3.7 Abnormity

The abnormity interface is shown as below. See Figure 7-52.

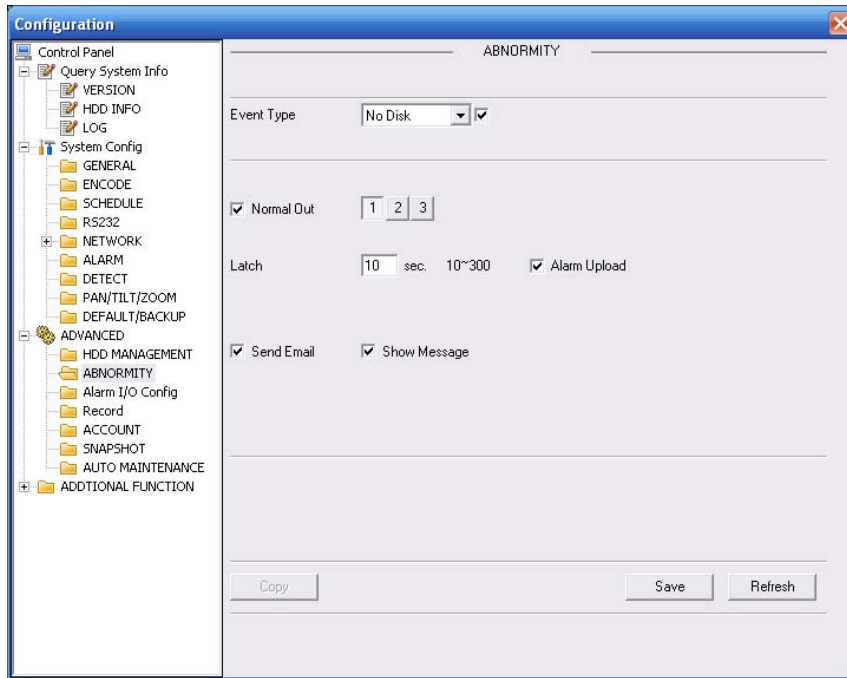

Figure 7-52

Please refer to the following sheet for detailed information.

Parameter	Function
Event Type	<ul style="list-style-type: none"> ✧ The abnormal events include: no disk, no space, disk error, net error. ✧ You need to draw a circle to enable this function.
Normal Out	The corresponding alarm activation output channel when alarm occurs, There are six channels.
Latch	<p>The alarm output can delay for the specified time after alarm stops. Then system disables alarm and corresponding activation output.</p> <p>The value ranges from 10s to 300s.</p>
Send email	If you enable this function, system can send out email to alarm the specified user.
Alarm upload	System can upload the alarm signal to the network (includes the alarm centre.)
Show message	System pops up the alarm messages in the monitor interface.
Buzzer	Once you check the box here, the buzzer beeps when an alarm occurred.

7.3.3.8 Video Matrix

Here you can set video matrix output four channel and corresponding interval. It supports 1/4/9/16-window mode and you can input the interval here. See Figure 7-53.

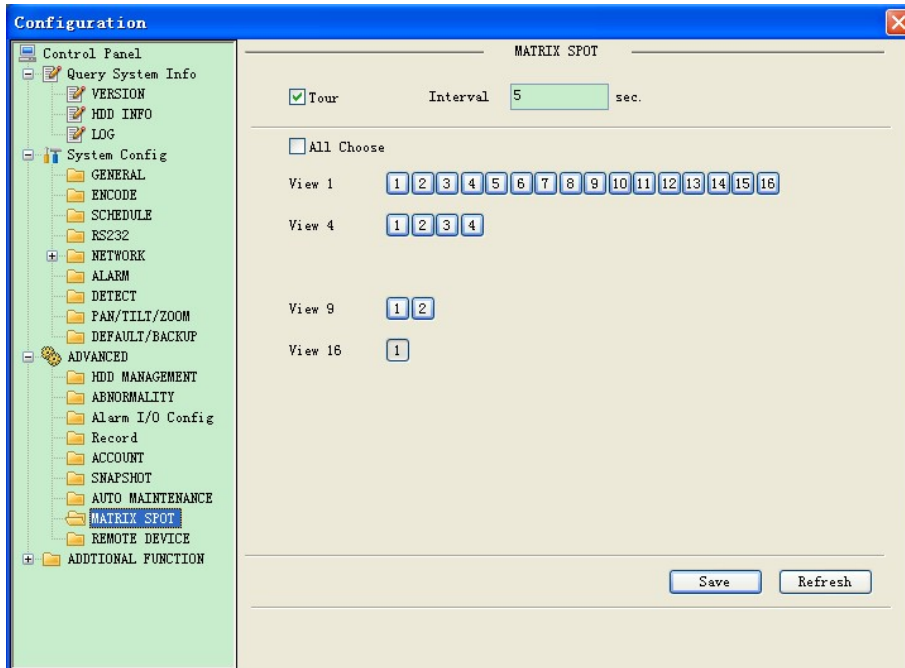

Figure 7-53

7.3.3.9 Remote Device

Here you can set IPC address, port, remote device channel number, login user name and its password. Now system supports 4 channel IPC connections (channel 17 to channel 20). See Figure 7-52.

Please refer to chapter 5.5.9 Remote Device for detailed information.

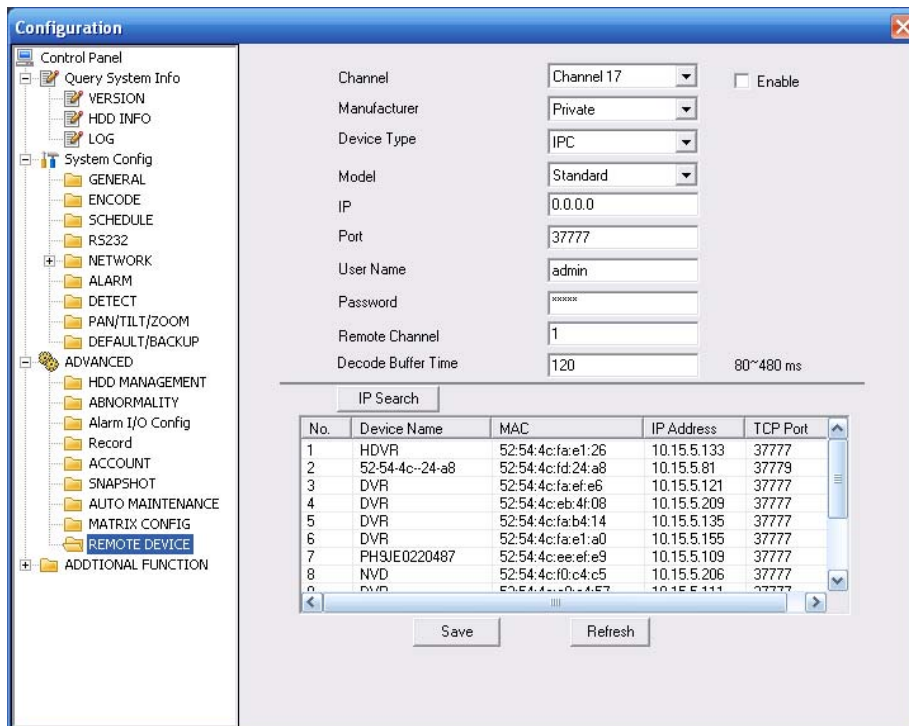

Figure 7-54

7.3.4 Additional Function

7.3.4.1 Preferred DNS

Here you can set server or local operator DNS address. See Figure 7-54.

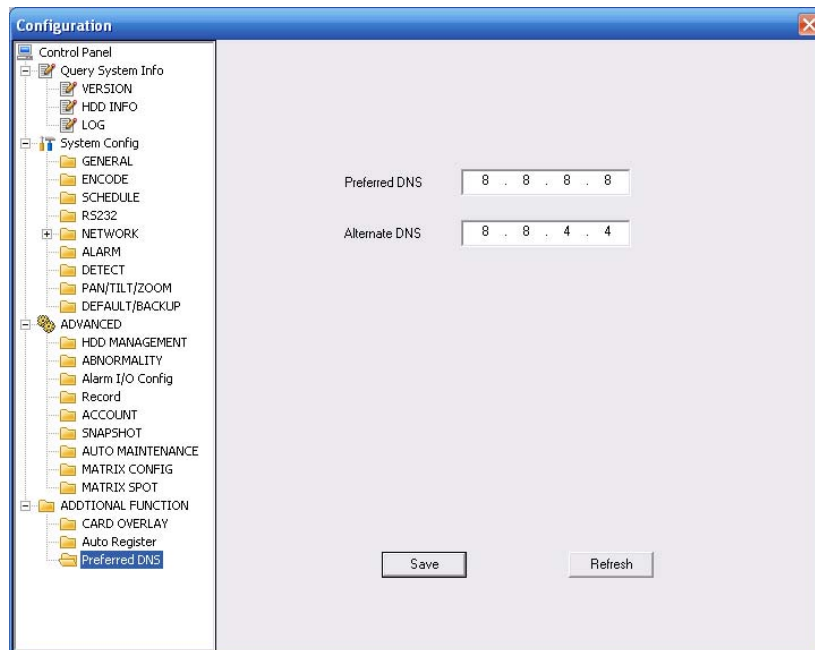

Figure 7-55

7.3.4.2 Card Overlay

Tit is the same with the card overlay function (chapter 5.5.9). It is mainly for financial areas to Sniffer, information parse and character overlay. The ATM/POS interface is shown as in Figure 7-55.

Source IP refers to host IP address that sends out information (usually it is the device host connected to the DVR.)

Destination IP refers to other systems that receive information.

There are total four groups IP. The record channel applies to one group (optional) only.

Six frame ID groups verification can guarantee information validity and legal.

The start position, length and data can be set according to your protocol and data packet.

There are total four fields.

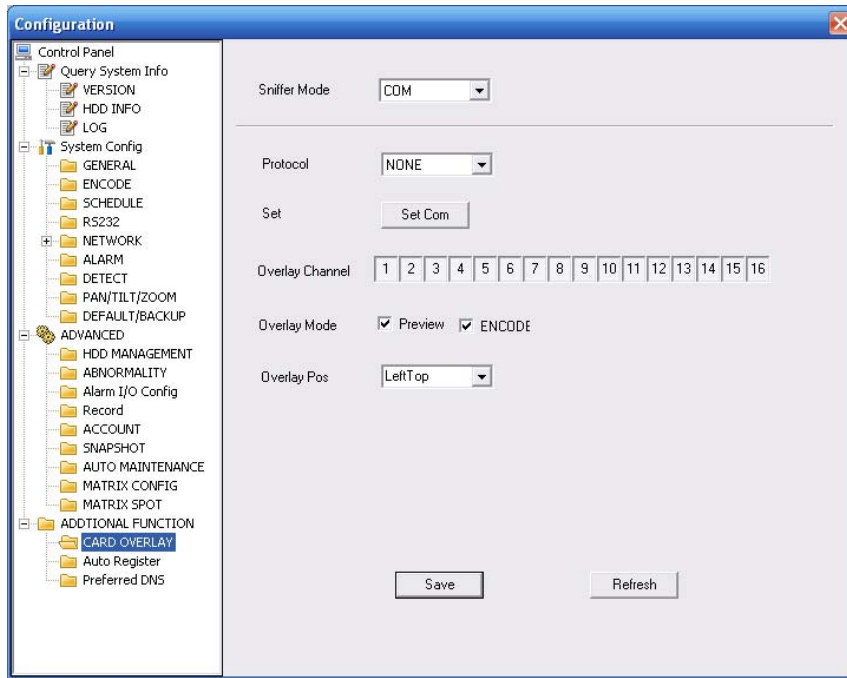

Figure 7-56

7.3.4.3 Auto Register

Auto register interface is shown as below. See Figure 7-56.

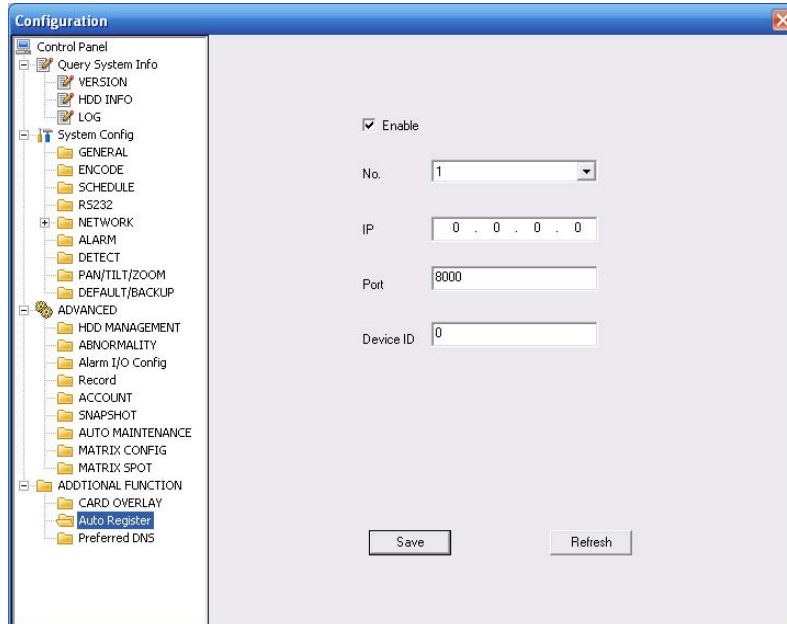

Figure 7-57 Auto Register

Please refer to the following sheet for detailed information.

Parameter	Function
Enable	Enable auto register function.

No.	Device management server number.
IP	Device management server IP address.
Port	Server port number.
Device ID	Device ID in the device management server.

7.4 Search

Click search button, you can see an interface is shown as in Figure 7-57.

The record type includes the general record, alarm record, motion detect record, local record, picture, card number record.

Please select record playback mode, and then select start time, end time and channel.

Then please click search button, you can see the corresponding files in the list.

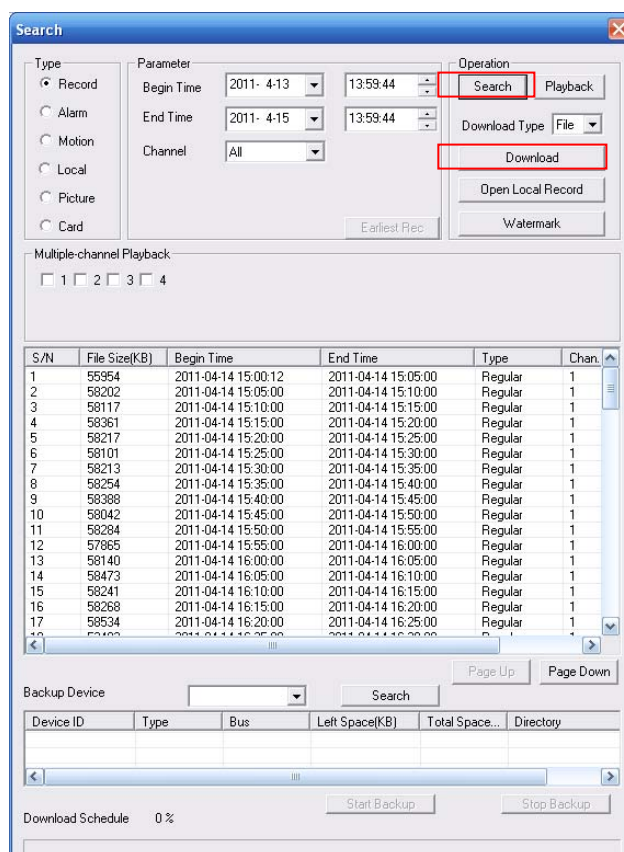

Figure 7-58

Select the file(s) you want to download and then click download button, system pops up a dialogue box shown as in Figure 7-58, then you can specify file name and path to download the file(s) to your local pc.

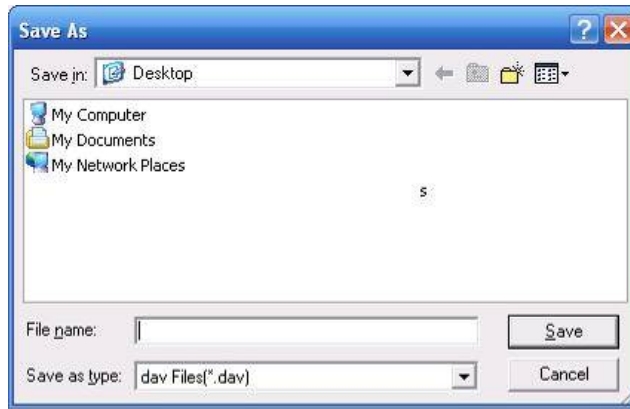

Figure 7-59

Now you can see system begins download and the download button becomes stop button. You can click it to terminate current operation.

At the bottom of the interface, there is a process bar for your reference. See Figure 7-59.

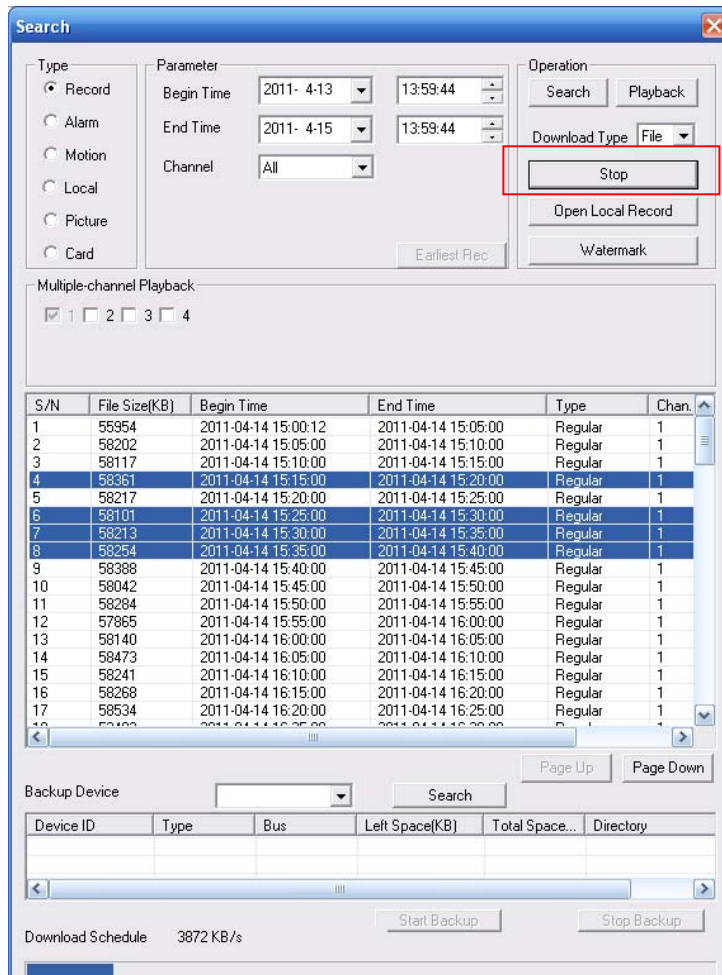

Figure 7-60

When download completed, you can see a dialogue box shown as in Figure 7-60. Please click OK to exit.



Figure 7-61

Please refer to the following sheet for detailed information.

Type	Parameter	Function
Type	Record	Search general record, alarm record and motion detection record.
	Alarm	Search alarm record.
	Motion Detection	Search motion detection record.
	Local	Search local record.
	Snapshot	Search snapshot file.
	Card	Search card file.
Item	Begin time	Set the file start time. You can select from the dropdown list.
	End time	Set the file end time. You can select from the dropdown list
	Channel	Select the channel from the dropdown list.
Operation	Search	Click this button you can view the recorded file matched your requirements. There are 100 files in one screen. You can use pg up/down button to view more files.
	Playback	Select the file first and then click playback button to view the video.
	Download type	Download by file: Select the file(s) and then click download button. Download by time: Download the recorded file(s) within your specified period.
	Download	Select the file you need (multiple choices) and then click download button, you can see system pops up a dialogue box. See Figure 7-55. Input the downloaded file name, specify the path and then click OK button. You can see system begins download and the download becomes stop button. There is a progress bar for your reference.
	Open local record	Select local record to play.

Type	Parameter	Function
	Earliest record	Select a channel first and then click the earliest record button; you can view the earliest record of the current channel in the HDD.
Multiple-channel playback		System supports playback one file in several monitor channels.

During the playback process, you can see there are control buttons such as play, pause, stop, slow play and fast play in the play process bar. You can view current playback file channel name, time and data statistics.

In the search result interface, you can select one or more files to download to your local PC.

The playback control bar is shown as below. See Figure 7-61.

- 1: Play
- 2: Pause
- 3: Stop
- 4: Slow play
- 5: Fast play



Figure 7-62

7.5 Alarm

Click alarm function, you can see an interface is shown as in Figure 7-62.

Here you can set device alarm type and alarm sound setup.

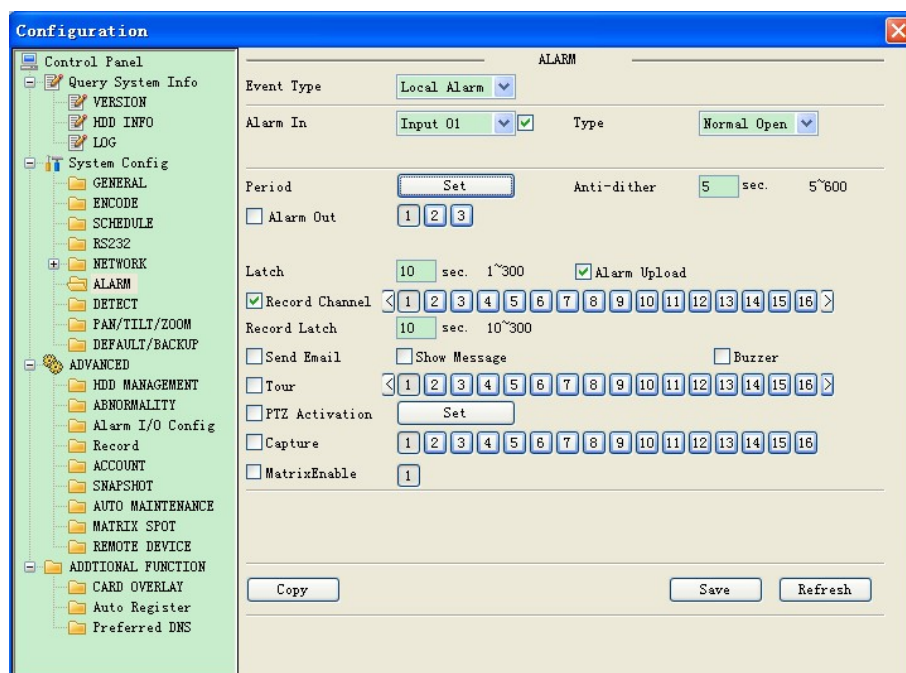

Figure 7-63

Please refer to the following sheet for detailed information.

Please make sure current device can upload the alarm.

Type	Parameter	Function
Alarm Type	Video loss	System alarms when video loss occurs.
	Motion detection	System alarms when motion detection alarm occurs,
	Disk full	System alarms when disk is full.
	Disk error	System alarms when disk error occurs.
	Camera masking	System alarms when camera is viciously masking.
Operation	Encode alarm	System alarms when peripheral device alarms.
	External alarm	Alarm input device sends out alarm.
	Listen alarm	System notifies web when alarm occurs (you select from the above event type), and then web can notify user.
	Video	When alarm occurs, system auto enables video monitor. This function only applies to video detection alarm (motion detection, video loss and camera masking).
	Prompt	Automatically pops up alarm dialogue box.

Type	Parameter	Function
	Sound pop up	System sends out alarm sound when alarm occurs. You can specify as you wish.
	Path	Here you can specify alarm sound file.

7.6 About

Click about button, you can view current web client information. See Figure 7-63.



Figure 7-64

7.7 Log out

Click log out button, system goes back to log in interface. See Figure 7-64.

You need to input user name and password to login again.

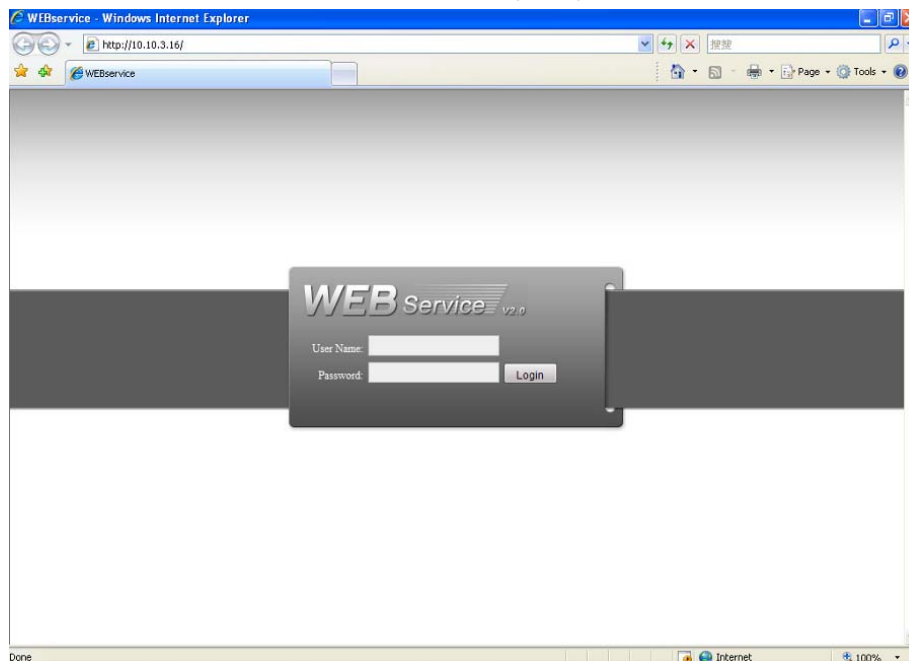

Figure 7-65

7.8 Un-install Web Control

You can use web un-install tool “uninstall web.bat” to un-install web control.

Please note, before you un-installation, please close all web pages, otherwise the un-installation might result in error.

8 Professional Surveillance System

Besides Web, you can use our Professional Surveillance Software (PSS) to login the device.

For detailed information, please refer to *PSS user's manual*.

9 FAQ

1. DVR can not boot up properly.

There are following possibilities:

- Input power is not correct.
- Power connection is not correct.
- Power switch button is damaged.
- Program upgrade is wrong.
- HDD malfunction or something wrong with HDD ribbon.
- Seagate DB35.1, DB35.2, SV35 or Maxtor 17-g has compatibility problem.
Please upgrade to the latest version to solve this problem.
- Front panel error.
- Main board is damaged.

2. DVR often automatically shuts down or stops running.

There are following possibilities:

- Input voltage is not stable or it is too low.
- HDD malfunction or something wrong with the ribbon.
- Button power is not enough.
- Front video signal is not stable.
- Working environment is too harsh, too much dust.
- Hardware malfunction.

3. System can not detect hard disk.

There are following possibilities:

- HDD is broken.
- HDD ribbon is damaged.
- HDD cable connection is loose.
- Main board SATA port is broken.

4. There is no video output whether it is one-channel, multiple-channel or all-channel output.

There are following possibilities:

- Program is not compatible. Please upgrade to the latest version.
- Brightness is 0. Please restore factory default setup.
- There is no video input signal or it is too weak.
- Check privacy mask setup or your screen saver.
- DVR hardware malfunctions.

5. Real-time video color is distorted.

There are following possibilities:

- When using BNC output, NTSC and PAL setup is not correct. The real-time video becomes black and white.

- DVR and monitor resistance is not compatible.
- Video transmission is too long or degrading is too huge.
- DVR color or brightness setup is not correct.

6. Can not search local records.

There are following possibilities:

- HDD ribbon is damaged.
- HDD is broken.
- Upgraded program is not compatible.
- The recorded file has been overwritten.
- Record function has been disabled.

7. Video is distorted when searching local records.

There are following possibilities:

- Video quality setup is too low.
- Program read error, bit data is too small. There is mosaic in the full screen. Please restart the DVR to solve this problem.
- HDD data ribbon error.
- HDD malfunction.
- DVR hardware malfunctions.

8. There is no audio when monitor.

There are following possibilities:

- It is not a power picker.
- It is not a power acoustics.
- Audio cable is damaged.
- DVR hardware malfunctions.

9. There is audio when monitor but there is no audio when system playback.

There are following possibilities:

- Setup is not correct. Please enable audio function
- Corresponding channel has no video input. Playback is not continuous when the screen is blue.

10. Time display is not correct.

There are following possibilities:

- Setup is not correct
- Battery contact is not correct or voltage is too low.
- Crystal is broken.

11. DVR can not control PTZ.

There are following possibilities:

- Front panel PTZ error

- PTZ decoder setup, connection or installation is not correct.
- Cable connection is not correct.
- PTZ setup is not correct.
- PTZ decoder and DVR protocol is not compatible.
- PTZ decoder and DVR address is not compatible.
- When there are several decoders, please add 120 Ohm between the PTZ decoder A/B cables furthest end to delete the reverberation or impedance matching. Otherwise the PTZ control is not stable.
- The distance is too far.

12. Motion detection function does not work.

There are following possibilities:

- Period setup is not correct.
- Motion detection zone setup is not correct.
- Sensitivity is too low.
- For some versions, there is hardware limit.

13. Can not log in client-end or web.

There are following possibilities:

- For Windows 98 or Windows ME user, please update your system to Windows 2000 sp4. Or you can install client-end software of lower version. Please note right now, our DVR is not compatible with Windows VISTA control.
- ActiveX control has been disabled.
- No dx8.1 or higher. Please upgrade display card driver.
- Network connection error.
- Network setup error.
- Password or user name is invalid.
- Client-end is not compatible with DVR program.

14. There is only mosaic no video when preview or playback video file remotely.

There are following possibilities:

- Network fluency is not good.
- Client-end resources are limit.
- There is multiple-cast group setup in DVR. This mode can result in mosaic. Usually we do not recommend this mode.
- There is privacy mask or channel protection setup.
- Current user has no right to monitor.
- DVR local video output quality is not good.

15. Network connection is not stable.

There are following possibilities:

- Network is not stable.
- IP address conflict.

- MAC address conflict.
- PC or DVR network card is not good.

16. Burn error /USB back error.

There are following possibilities:

- Burner and DVR are in the same data cable.
- System uses too much CPU resources. Please stop record first and then begin backup.
- Data amount exceeds backup device capacity. It may result in burner error.
- Backup device is not compatible.
- Backup device is damaged.

17. Keyboard can not control DVR.

There are following possibilities:

- DVR serial port setup is not correct
- Address is not correct
- When there are several switchers, power supply is not enough.
- Transmission distance is too far.

18. Alarm signal can not be disarmed.

There are following possibilities:

- Alarm setup is not correct.
- Alarm output has been open manually.
- Input device error or connection is not correct.
- Some program versions may have this problem. Please upgrade your system.

19. Alarm function is null.

There are following possibilities:

- Alarm setup is not correct.
- Alarm cable connection is not correct.
- Alarm input signal is not correct.
- There are two loops connect to one alarm device.

20. Remote control does not work.

There are following possibilities:

- Remote control address is not correct.
- Distance is too far or control angle is too small.
- Remote control battery power is low.
- Remote control is damaged or DVR front panel is damaged.

21. Record storage period is not enough.

There are following possibilities:

- Camera quality is too low. Lens is dirty. Camera is installed against the light. Camera aperture setup is not correct.
- HDD capacity is not enough.
- HDD is damaged.

22. Can not playback the downloaded file.

There are following possibilities:

- There is no media player.
- No DXB8.1 or higher graphic acceleration software.
- There is no DivX503Bundle.exe control when you play the file transformed to AVI via media player.
- No DivX503Bundle.exe or ffdshow-2004 1012 .exe in Windows XP OS.

23. Forget local menu operation password or network password

Please contact your local service engineer or our sales person for help. We can guide you to solve this problem.

Daily Maintenance

- Please use the brush to clean the board, socket connector and the chassis regularly.
- The device shall be soundly earthed in case there is audio/video disturbance. Keep the device away from the static voltage or induced voltage.
- Please unplug the power cable before you remove the audio/video signal cable, RS232 or RS485 cable.
- Do not connect the TV to the local video output port (VOUT).It may result in video output circuit.
- Always shut down the device properly. Please use the shutdown function in the menu, or you can press the power button in the front pane for at least three seconds to shut down the device. Otherwise it may result in HDD malfunction.
- Please make sure the device is away from the direct sunlight or other heating sources. Please keep the sound ventilation.
- Please check and maintain the device regularly.

Appendix A HDD Capacity Calculation

Calculate total capacity needed by each DVR according to video recording (video recording type and video file storage time).

Step 1: According to Formula (1) to calculate storage capacity q_i that is the capacity of each channel needed for each hour, unit Mbyte.

$$q_i = d_i \div 8 \times 3600 \div 1024 \quad (1)$$

In the formula: d_i means the bit rate, unit Kbit/s

Step 2: After video time requirement is confirmed, according to Formula (2) to calculate the storage capacity m_i , which is storage of each channel needed unit Mbyte.

$$m_i = q_i \times h_i \times D_i \quad (2)$$

In the formula:

h_i means the recording time for each day (hour)

D_i means number of days for which the video shall be kept

Step 3: According to Formula (3) to calculate total capacity (accumulation) q_T that is needed for all channels in the DVR during **scheduled video recording**.

$$q_T = \sum_{i=1}^c m_i \quad (3)$$

In the formula: c means total number of channels in one DVR

Step 4: According to Formula (4) to calculate total capacity (accumulation) q_T that is needed for all channels in DVR during **alarm video recording (including motion detection)**.

$$q_T = \sum_{i=1}^c m_i \times a\% \quad (4)$$

In the formula: $a\%$ means alarm occurrence rate

You can refer to the following sheet for the file size in one hour per channel. (All the data listed below are for reference only.)

Bit stream size (max)	File size	Bit stream size (max)	File size
96K	42M	128K	56M
160K	70M	192K	84M
224K	98M	256K	112M
320K	140M	384K	168M

448K	196M	512K	225M
640K	281M	768K	337M
896K	393M	1024K	450M
1280K	562M	1536K	675M
1792K	787M	2048K	900M

Appendix B Compatible backup devices

Appendix B-1 Compatible USB list

Manu factor	Model	Capacity
Sandisk	Cruzer Micro	512M
Sandisk	Cruzer Micro	1G
Sandisk	Cruzer Micro	2G
Sandisk	Cruzer Freedom	256M
Sandisk	Cruzer Freedom	512M
Sandisk	Cruzer Freedom	1G
Sandisk	Cruzer Freedom	2G
Kingston	DataTraveler II	1G
Kingston	DataTraveler II	2G
Kingston	DataTraveler	1G
Kingston	DataTraveler	2G
Maxell	USB Flash Stick	128M
Maxell	USB Flash Stick	256M
Maxell	USB Flash Stick	512M
Maxell	USB Flash Stick	1G
Maxell	USB Flash Stick	2G
Kingax	Super Stick	128M
Kingax	Super Stick	256M
Kingax	Super Stick	512M
Kingax	Super Stick	1G
Kingax	Super Stick	2G
Netac	U210	128M
Netac	U210	256M
Netac	U210	512M
Netac	U210	1G
Netac	U210	2G
Netac	U208	4G
Teclast	Ti Cool	128M
Teclast	Ti Cool	256M
Teclast	Ti Cool	512M
Teclast	Ti Cool	1G
SanDisk	cruzer mirco	2G
SanDisk	cruzer mirco	8G
SanDisk	Ti Cool	2G
SanDisk	Hongjiao	4G
Lexar	Lexar	256MB
Kingston	Data Traveler	1G
Kingston	Data Traveler	16GB

Kingston	Data Traveler	32GB
Aigo	L8315	16GB
Sandisk	250	16GB
Kingston	Data Traveler Locker+	32GB
Netac	U228	8GB

Appendix B-2 Compatible SD Card list

Brand	Standard	Capacity	Card type
Transcend	SDHC6	16GB	Big
Kingston	SDHC4	4GB	Big
Kingston	SD	2GB	Big
Kingston	SD	1GB	Big
Sandisk	SDHC2	8GB	Small
Sandisk	SD	1GB	Small

Appendix B-3 Compatible Portable HDD list

Brand	Model	Capacity
YDStar	YDstar HDD box	40G
Netac	Netac	80G
lomega	lomega RPHD-CG" RNAJ50U287	250GB
WD Elements	WCAVY1205901	1.5TB
Newsmy	Liangjian	320GB
WD Elements	WDBAAR5000ABK-00	500GB
WD Elements	WDBAAU0015HBK-00	1.5TB
Seagate	FreeAgent Go(ST905003F)	500GB
Aigo	H8169	500GB

Appendix B-4 Compatible USB DVD List

Brand	Model
Sony	DRX-S70U
Benq	TW200D

Appendix B-5 Compatible SATA DVD List

Brand	Model
Pioneer	DVR-215CHG
Panasonic	SW-9588-C

Sumsung	TS-H653
Sony	DRU-V200S
Sony	DRU-845S
Sumsung	TS-H653
Pioneer	DVR-217CHG
LG	GH22NS30

Appendix B-6 Compatible SATA HDD List

NOTE: Please upgrade the DVR firmware to latest version to ensure the accuracy of the table below. And SATA HDD should be used for the DVR with SATA port.

Manufacturer	Series	Model	Capacity	Port Mode
Seagate	Barracuda.10	ST3750640AS	750G	SATA
Seagate	Barracuda.10	ST3500630AS	500G	SATA
Seagate	Barracuda.10	ST3400620AS	400G	SATA
Seagate	Barracuda.10	ST3320620AS	320G	SATA
Seagate	Barracuda.10	ST3250620AS	250G	SATA
Seagate	Barracuda.10	ST3250820AS	250G	SATA
Seagate	Barracuda.10	ST3160815AS	160G	SATA
Seagate	Barracuda.10	ST380815AS	80G	SATA
Seagate	Barracuda.9	ST3160811AS	160G	SATA
Seagate	Barracuda.9	ST3120811AS	120G	SATA
Seagate	Barracuda.9	ST380811AS	80	SATA
Seagate	Barracuda.9	ST380211AS	80G	SATA
Seagate	Barracuda.11	ST3750330AS	750G	SATA
Seagate	Barracuda.11	ST3500320AS	500G	SATA
Seagate	Barracuda 7200.11	ST31500341AS	1.5T	SATA
Seagate	Barracuda ES.2	ST31000340NS	1T	SATA
Seagate	Pipeline HD.2	ST31000424CS	1T	SATA
Seagate	Pipeline HD.2	ST3320311CS	320G	SATA
Seagate	Barracuda	ST31000340AS	1T	SATA
Seagate	ES.2	ST31000340AS	1T	SATA
Seagate	SV35.2	ST3160815SV	160G	SATA
Seagate	SV35.2	ST3250310SV	250G	SATA
Seagate	SV35.2	ST3320620SV	320G	SATA
Seagate	SV35.2	ST3500320SV	500G	SATA
Seagate	SV35.2	ST3750640SV	750G	SATA
Seagate	SV35.2	ST3320320SV	320G	SATA
Seagate	SV35.2	ST3500630SV	500G	SATA
Seagate	SV35.3	ST31000340SV	1T	SATA
Seagate	SV35.3	ST3250310SV	250G	SATA
Seagate	SV35.3	ST3750330SV	750G	SATA

Seagate	SV35.5	ST3250311SV	250G	SATA
Seagate	SV35.5	ST3500410SV	500G	SATA
Seagate	SV35.5	ST31000525SV	1TB	SATA
Seagate	SV35.5	ST310005258V	1TB	SATA
Maxtor	DiamondMax 20	STM3320820AS	320G	SATA
Maxtor	DiamondMax 20	STM3250820AS	250G	SATA
Maxtor	DiamondMax 21	STM3160211AS	160G	SATA
Maxtor	DiamondMax 21	STM380211AS	80G	SATA
Maxtor	DiamondMax 21	STM340211AS	40G	SATA
Western Digital	CE	WD5000AVJS	500G	SATA
Western Digital	CE	WD3200AVJS	320G	SATA
Western Digital	CE	WD2500AVBS	250G	SATA
Western Digital	CE	WD10EVCS	1T	SATA
Western Digital	Cariar SE	WD3200JD	320G	SATA
Western Digital	Cariar SE	WD3000JD	300G	SATA
Western Digital	Cariar SE	WD2500JS	250G	SATA
Western Digital	Cariar SE	WD2000JD	200G	SATA
Western Digital	Cariar SE	WD1600JD	160G	SATA
Western Digital	Cariar SE	WD1600JS	160G	SATA
Western Digital	Cariar SE	WD1200JS	120G	SATA
Western Digital	Cariar SE	WD800JD	80G	SATA
Western Digital	Cariar	WD1600AABS	160G	SATA
Western Digital	Cariar	WD800BD	80G	SATA
Western Digital	Cariar SE16	WD7500KS	750G	SATA
Western Digital	Cariar SE16	WD5000KS	500G	SATA
Western Digital	Cariar SE16	WD4000KD	400G	SATA
Western Digital	Cariar SE16	WD3200KS	320G	SATA
Western Digital	Cariar SE16	WD2500KS	250G	SATA
Western Digital	RE Series	WD5000ABYS	500G	SATA
Western Digital	RE2 Series	WD7500AYYS	750G	SATA
Western Digital	Caviar Green Series	WD20EADS	2T	SATA
Western Digital	Caviar Green Series	WD15EADS	1.5TB	SATA
Western Digital	Western digital(DVR only)	WD10EVVS-63M5BO	1TB	SATA
Western Digital	Western digital (DVR only)	WD20EVDS-63T3B0	2TB	SATA
Western Digital	Western digital (DVR only)	WD15EVDS-63V9B0	1.5TB	SATA
Western Digital	Western digital (DVR only)	WD10EVVSWDV-GP	1TB	SATA
Western Digital	Western digital (unknown series)	WD5000AVVS-63M8BO	500GB	SATA

Western Digital	Western digital	WD20EURS-63Z9B1	2TB	SATA
Western Digital	Western digital	WD10EURS-630AB1	1TB	SATA
SAMSUNG	/	HA101UJ/CE	1T	SATA
SAMSUNG	Spinpoint F1 CE	HA751LJ	750G	SATA
SAMSUNG	/	HA101UJ/CE	1TB	SATA
SAMSUNG	/	HD103SI/CE	1TB	SATA
SAMSUNG	/	HD154UI/CE	1.5TB	SATA
HITACHI	Cinema	HCS545050GLA380	500GB	SATA
HITACHI	Cinema	HCP725050LA380	500GB	SATA
HITACHI	Deskstar	HDS721010KLA330	1TB	SATA
HITACHI	Hitachi (unknown series)	HCT721010SLA360	1TB	SATA
HITACHI	Hitachi	HCS5C1050CLA382	500GB	SATA
HITACHI	Hitachi	HCS5C1050CLA382	1TB	SATA
HITACHI	Hitachi	HCS721010CLA332	1TB	SATA

Appendix C Compatible CD/DVD Burner List

NOTE: Please upgrade the DVR firmware to latest version to ensure the accuracy of the table below. And you can use the USB cable with the model recommended to set USB burner.

Manufacturer	Model	Port Type	Type
Sony	DRX-S50U	USB	DVD-RW
Sony	DRX-S70U	USB	DVD-RW
Sony	AW-G170S	SATA	DVD-RW
Samsung	TS-H653A	SATA	DVD-RW
Panasonic	SW-9588-C	SATA	DVD-RW
Sony	DRX-S50U	USB	DVD-RW
BenQ	5232WI	USB	DVD-RW

Appendix D Compatible Displayer List

Please refer to the following sheet form compatible displayer list.

Brand	Model	Dimension (Unit: inch)
BENQ (LCD)	ET-0007-TA	19-inch (wide screen)
DELL (LCD)	E178FPc	17-inch
BENQ (LCD)	Q7T4	17-inch
BENQ (LCD)	Q7T3	17-inch
HFNOVO (LCD)	LXB-L17C	17-inch
SANGSUNG (LCD)	225BW	22 寸(wide screen)
HFNOVO(CRT)	LXB-FD17069HB	17 -inch
HFNOVO(CRT)	LXB-HF769A	17-inch
HFNOVO(CRT)	LX-GJ556D	17-inch
Samsung (LCD)	2494HS	24-inch
Samsung (LCD)	P2350	23-inch
Samsung (LCD)	P2250	22-inch
Samsung (LCD)	P2370G	23-inch
Samsung (LCD)	2043	20-inch
Samsung (LCD)	2243EW	22-inch
Samsung (LCD)	SMT-1922P	19-inch
Samsung (LCD)	T190	19-inch
Samsung (LCD)	T240	24-inch
LG (LCD)	W1942SP	19-inch
LG (LCD)	W2243S	22-inch
LG (LCD)	W2343T	23-inch
BENQ (LCD)	G900HD	18.5-inch
BENQ(LCD)	G2220HD	22-inch
PHILIPS (LCD)	230E	23-inch
PHILIPS (LCD)	220CW9	23-inch
PHILIPS (LCD)	220BW9	24-inch
PHILIPS (LCD)	220EW9	25-inch

Appendix E Compatible Switcher

Brand	Model	network working mode
D-LinK	DES-1016D	10/100M self-adaptive
D-LinK	DES-1008D	10/100M self-adaptive
Ruijie	RG-S1926S	Five network modes 1. AUTO 2. HALF-10M 3. FULL-10M 4. HALF-100M 5. FULL-100M
H3C	H3C-S1024	10/100M self-adaptive
TP-LINK	TL-SF1016	10/100M self-adaptive
TP-LINK	TL-SF1008+	10/100M self-adaptive

Appendix F Compatible Wireless Mouse List

Please refer to the following sheet for compatible SD card brand.

Brand	Model
SUNT 讯拓™	V80
Rapoo	3500
Logitech	M215
Shuangfeiyan	Tianyao G7-630

Appendix G Earthing

1. What is the surge?

Surge is a short current or voltage change during a very short time. In the circuit, it lasts for microsecond. In a 220V circuit, the 5KV or 10KV voltage change during a very short time (about microseconds) can be called a surge. The surge comes from two ways: external surge and internal surge.

- The external surge: The external surge mainly comes from the thunder lightning. Or it comes from the voltage change during the on/off operation in the electric power cable.
- The internal surge: The research finds 88% of the surge from the low voltage comes from the internal of the building such as the air conditioning, elevator, electric welding, air compressor, water pump, power button, duplicating machine and other device of inductive load.

The lightning surge is far above the load level the PC or the micro devices can support. In most cases, the surge can result in electric device chip damage, PC error code, accelerating the part aging, data loss and etc. Even when a small 20 horsepower inductive engine boots up or stops, the surge can reach 3000V to 50000V, which can adversely affect the electronic devices that use the same distribution box.

To protect the device, you need to evaluate its environment, the lightning affection degree objectively. Because surge has close relationship with the voltage amplitude, frequency, network structure, device voltage-resistance, protection level, ground and etc. The thunder proof work shall be a systematic project, emphasizing the all-round protection (including building, transmission cable, device, ground and etc.). There shall be comprehensive management and the measures shall be scientific, reliable, practical and economic. Considering the high voltage during the inductive thundering, the International Electrotechnical Committee (IEC) standard on the energy absorbing step by step theory and magnitude classification in the protection zone, you need to prepare multiple precaution levels.

You can use the lightning rod, lightning strap or the lightning net to reduce the damage to the building, personal injury or the property,

- The lightning protection device can be divided into three types:
Power lightning arrester: There are 220V single-phrase lightning arrester and 380V three-phrase lightening arrester (mainly in parallel connection, sometimes use series connection) You can parallel connect the power lightning arrester in the electric cable to reduce the short-time voltage change and release the surge current. From the BUS to the device, there are usually three levels so that system can reduce the voltage and release the current step by step to remove the thunderstorm energy and guarantee the device safety. You can select the replaceable module type, the terminal connection type and portable socket according to your requirement.

- Signal lightning arrester: This device is mainly used in the PC network, communication system. The connection type is serial connection. Once you connected the signal lightning arrester with the signal port, it can cut the channel of the thunderstorm to the device, and on the other hand, it can discharge the current to the ground to guarantee the device proper work. The signal lightning arrester has many specifications, and widely used in many devices such as telephone, network, analog communication, digital communication, cable TV and satellite antenna. For all the input port, especially those from the outdoor, you need to install the signal lightning arrester.
- Antenna feed cable lightning arrester: It is suitable for antenna system of the transmitter or the device system to receive the wireless signal. It uses the serial connection too.

Please note, when you select the lightning arrester, please pay attention to the port type and the earthing reliability. In some important environment, you need to use special shielded cable. Do not parallel connect the thunder proof ground cable with the ground cable of the lightning rod. Please make sure they are far enough and grounded respectively.

2. The earthing modes

We all know the earthing is the most complicated technology in the electromagnetism compatibility design since there is no systematic theory or module. The earthing has many modes, but the selection depends on the system structure and performance. The following are some successfully experience from our past work.

One-point ground: In the following figure you can see there is a one-point ground. This connection provides common port to allow signal to be transmitted in many circuits. If there is no common port, the error signal transmission occurred. In the one-point ground mode, each circuit is just grounded only and they are connected at the same port. Since there is only one common port, there is no circuit and so, there is no interference.

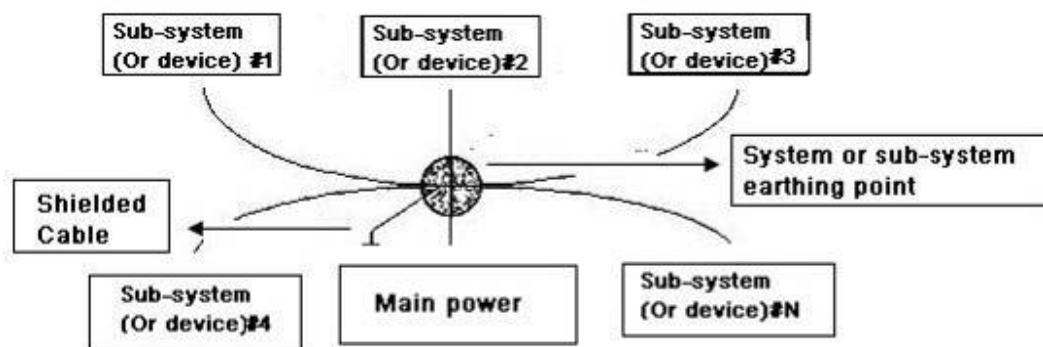

Multiple-point ground: In the following figure, you can see the internal circuit uses the chassis as the common point. While at the same time, all devices chassis use the earthing as the common port. In this connection, the ground structure can provide the lower ground resistance because when there are multiple-point grounds; each ground cable is as short as possible. And the parallel cable connection can reduce the total

conductance of the ground conductor. In the high-frequency circuit, you need to use the multiple-point ground mode and each cable needs to connect to the ground. The length shall be less than the 1/20 of the signal wavelength.

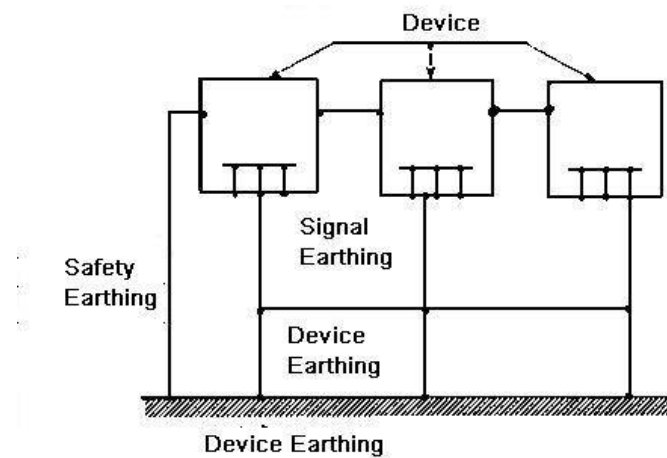

Mixed ground: The mixed ground consists of the feature of the one-point ground and multiple-point ground. For example, the power in the system needs to use the one-point ground mode while the radio frequency signal requires the multiple-point ground. So, you can use the following figure to earth. For the direct current (DC), the capacitance is open circuit and the circuit is one-point ground. For the radio frequency signal, the capacitance is conductive and the circuit adopts multiple-point ground.

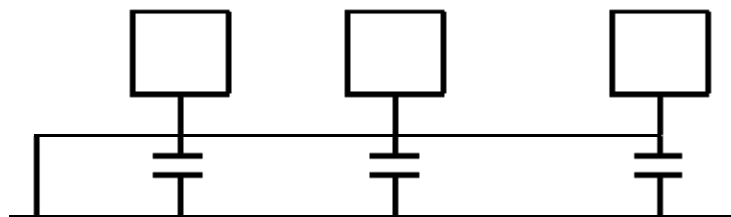

When connecting devices of huge size (the device physical dimension and connection cable is big comparing with the wave path of existed interference), then there are possibility of interference when the current goes through the chassis and cable. In this situation, the interference circuit path usually lies in the system ground circuit.

When considering the earthing, you need to think about two aspects: The first is the system compatibility, and the other is the external interference coupling into the earth circuit, which results in system error. For the external interference is not regular, it is not easy to resolve.

3. Thunder proof ground method in the monitor system

- The monitor system shall have sound thunder proof earthing to guarantee personnel safety and device safety.
- The monitor system working ground resistance shall be less than 1Ω.

- The thunder proof ground shall adopt the special ground cable from the monitor control room to the ground object. The ground cable adopts copper insulation cable or wire and its ground section shall be more than 20mm².
- The ground cable of the monitor system can not short circuit or mixed connected with the strong alternative current cable.
- For all the ground cables from the control room to the monitor system or ground cable of other monitor devices, please use the copper resistance soft cable and its section shall be more than 4mm².
- The monitor system usually can adopt the one-point ground.
- Please connect the ground end of 3-pin socket in the monitor system to the ground port of the system (protection ground cable)

4. The shortcut way to check the electric system using the digital multimeter

For 220V AC socket, from the top to the bottom, E (ground cable), N (neutral cable), L(live cable). Please refer to the following figure.

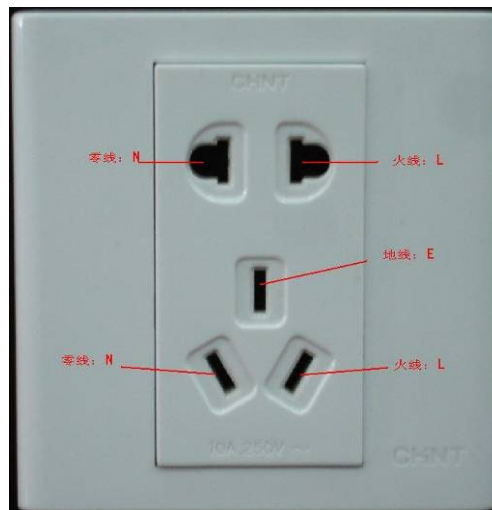

There is a shortcut way to check these three cables connection are standard or not (not the accurate check).

Importance

In the following operations, the multimeter range shall be at 750V!

For E (earth cable)

Turn the digital multimeter to 750V AC, use your one hand to hold the metal end, and then the other hand insert the pen to the E port of the socket. See the following figure. If the multimeter shows 0, then you can see current earth cable connection is standard. If the value is more than 10, then you can see there is inductive current and the earth cable connection is not proper.



For L (live cable)

Turn the digital multimeter to 750V AC, use your one hand to hold the metal end, and then the other hand insert the pen to the L port of the socket. See the following figure. If the multimeter shows 120, then you can see current live cable connection is standard. If the value is less than 60, then you can see current live cable connection is not proper or it is not the live cable at all.



For N (Neutral cable)

Turn the digital multimeter to 750V AC, use your one hand to hold the metal end, and then the other hand insert the pen to the N port of the socket. See the following figure. If the multimeter shows 0, then you can see current N cable connection is standard. If the value is more than 10, then you can see there is inductive current and the neutral cable connection is not proper. If the value is 120, then you can know misconnected the neutral cable to the live cable.

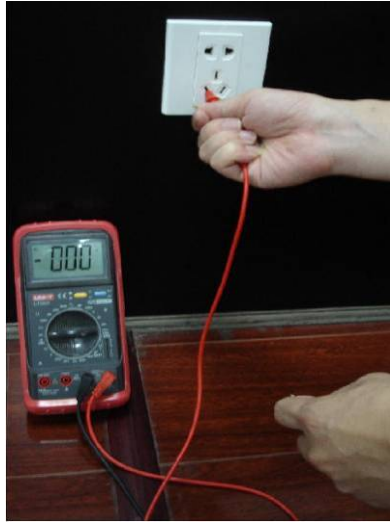

Appendix H Toxic or Hazardous Materials or Elements

Component Name	Toxic or Hazardous Materials or Elements					
	Pb	Hg	Cd	Cr VI	PBB	PBDE
Sheet Metal(Case)	○	○	○	○	○	○
Plastic Parts (Panel)	○	○	○	○	○	○
Circuit Board	○	○	○	○	○	○
Fastener	○	○	○	○	○	○
Wire and Cable/AC Adapter	○	○	○	○	○	○
Packing Material	○	○	○	○	○	○
Accessories	○	○	○	○	○	○

O: Indicates that the concentration of the hazardous substance in all homogeneous materials in the parts is below the relevant threshold of the SJ/T11363-2006 standard.

X: Indicates that the concentration of the hazardous substance of at least one of all homogeneous materials in the parts is above the relevant threshold of the SJ/T11363-2006 standard. During the environmental-friendly use period (EFUP) period, the toxic or hazardous substance or elements contained in products will not leak or mutate so that the use of these (substances or elements) will not result in any severe environmental pollution, any bodily injury or damage to any assets. The consumer is not authorized to process such kind of substances or elements, please return to the corresponding local authorities to process according to your local government statutes

Note:

- **This manual is for reference only. Slight difference may be found in the user interface.**
- **All the designs and software here are subject to change without prior written notice.**
- **If there is any uncertainty or controversy, please refer to the final explanation of us.**
- **Please visit our website or contact your local retailer for more information.**