HD-AVS Intelligent Speed Dome User's Manual

Version 1.0.0

Table of Contents

1	FEATURES AND FUNCTIONS.....	1
1.1	General Introduction	1
1.2	Features	1
1.2.1	HD Video	1
1.2.2	Long-Distance Transmission without Any Loss	1
1.2.3	Coaxial Control	1
1.2.4	On-Screen Menu	1
1.2.5	Proportional Pan and Tilt	1
1.2.6	On-screen Tips	1
1.2.7	Preset	1
1.2.8	Auto Scan	1
1.2.9	Auto Tour	2
1.2.10	Auto Pattern	2
1.2.11	Privacy Masking	2
1.2.12	Action on Alarm	2
1.2.13	Auto Flip	2
1.2.14	Self-diagnosis	2
1.2.15	Day/Night Mode (B/W & Color Mode)	2
1.2.16	Auto Focus	2
1.2.17	Backlight Compensation	2
1.2.18	Pan Tilt and Zoom	2
1.2.19	3D Intelligent Location	2
1.2.20	Idle Status	2
1.2.21	Power up	2
1.2.22	Image Flip	2
2	PREPARATION WORKS	3
2.1	HD-AVS	3
2.2	Serial.....	3
2.2.1	Protocol/Baud Rate /Address Setup	3
2.2.2	Baud Rate and Parity	4
2.2.3	Set address dial switch	5

3	MENU	6
3.1	Screen Menu Index	6
3.2	Self-diagnosis System Information	7
3.3	Main Menu	7
3.4	Menu Operation	8
3.4.1	System Setting	8
3.4.2	Display Setting	9
3.4.3	Camera Setting	9
3.4.4	Function Setting	14
3.4.5	Alarm Setting	20
	3.5 Dome Abnormal Phenomenon Operation	20
	3.5.1 Restore to Factory Default Setup	20
	3.5.2 PTZ Movement is not smooth	20
	3.5.3 Can not use coaxial cable to control the speed dome	20
4	CABLE CONNECTION	21
4.1	Cable Connection	21
4.2	System Layout	22
4.2.1	System Connection	22
4.2.2	Alarm Connection	22
4.2.3	Keyboard Connection	23
5	FAQ	24
5.1	Daily Maintenance	24
5.2	Problems and Solutions	24
6	APPENDIX I LIGHTENING PROTECTION AND SURGE PROTECTION	25
7	APPENDIX 2 THE RELATIONSHIP BETWEEN THE 24V AC CABLE DIAMETER AND THE TRANSMISSION DISTANCE	26

8 APPENDIX 3 WIRE GAUGE REFERENCE SHEET27

9 APPENDIX 4 TOXIC OR HAZARDOUS MATERIALS OR ELEMENTS28

Welcome

Thank you for purchasing our product!

This user's manual is designed to be a reference tool for the operation of your system.

Here you can find information about this speed dome features and functions, as well as a detailed menu tree. Please keep it well for future reference!

Before installation and operation, please read the following safeguards and warnings carefully!

Important Safeguards and Warnings

1 . Electrical safety

- All installation and operation here should conform to your local electrical safety codes.
- The power shall conform to the requirement in the SELV (Safety Extra Low Voltage) and the Limited power source is rated 24V AC in the IEC60950-1.
- We assume no liability or responsibility for all the fires or electrical shock caused by improper handling or installation.
- We are not liable for any problems caused by unauthorized modification or attempted repair.

2 . Transportation Security

- No heavy stress, violent vibration or water splash are allowed during transportation, storage and installation.
- Please use the original packing material (or the material of the same quality) when you ship it back to the manufacturer.

3 . Installation

- Do not apply power to the product before completing installation.
- Please install the proper power cut-off device during the installation connection.
- Do not put object on the product.

4 . Environment

- This series product should be installed in a cool, dry place away from direct sunlight, inflammable, explosive substances and etc.
- Please keep it away from the electromagnetic radiation object and environment.
- Please keep the sound ventilation.
- Do not allow the water and other liquid falling into the device.
- Please make sure the CCD (CMOS) component is out of the radiation of the laser beam device. Otherwise it may result in CCD (CMOS) optical component damage.
- Thunder-proof device is recommended to be adopted to better prevent thunder.
- The grounding holes of the product are recommended to be grounded to further enhance the reliability of the camera.

5. Daily Maintenance

- Current series product has no power button. Please unplug all corresponding power cables before your begin installation or daily maintenance work.
- Please keep the dustproof cap back to protect the CCD or CMOS part if the device does not work for a long time.
- Do not touch CCD (CMOS) component. You can use the blower to clean the dust on the surface of the device. You can use the dry cloth with some alcohol or mild detergent to clear if necessary.
- Do not use the volatility solvent such as the benzene or thinner, or detergent with strong abrasibility. It may result in lens damage or it may adversely affect the device performance.

-
- If there is too much dust, please use the water to dilute the mild detergent first and then use it to clean the device. Finally use the dry cloth to clean the device.

- **6. About Accessories**

Always use all the accessories recommended by manufacturer.

Before installation, please open the package and check that all the components are included in the package: Contact you local retailer ASAP if something is missing in your package.

1 Features and Functions

1.1 General Introduction

HD-AVS (High Definition Analog Video System) is the HD video transmission specifications via the coaxial cable. It adopts analog modulation technology to transmit progressive HD video.

This product integrates block camera and PTZ together. It is easy to install and use. It enjoys high resolution, which meets the customers' needs for surveillance at HD level. This product also supports privacy masking, alarm activation, WDR, high light reduce and some other functions. Comparing with the traditional HD transmission distance limit, it uses HD-AVS technology to guarantee transmission safety and reliability of the audio/video. Thus, it realizes a real-time surveillance from anywhere at anytime. It can transmit multiple-signal via one cable and it is easy to operate.

Comparing with the general products, this series HD-AVS speed dome has some new features. It supports PTZ rotation speed can automatically adjust according to the zoom rate of the lens. It supports various languages, real-time clock function and protocol auto recognition. It supports 360° continuously pan, 90°tilt and 180° auto flip. It can realize no blind spot monitor.

1.2 Features

This series speed dome has the following features:

1.2.1 HD Video

Megapixel HD resolution.

1.2.2 Long-Distance Transmission without Any Loss

More than 500M transmission distance via 75-3 coaxial cable.

1.2.3 Coaxial Control

Support control signal transmission via the coaxial cable.

1.2.4 On-Screen Menu

This series product menu supports multiple languages.

It is easy for you to view dome information and configure dome, camera parameters.

1.2.5 Proportional Pan and Tilt

This function keeps the image from moving too fast when there is a large amount of zoom.

This series speed dome continually decreases or increases pan and tilt speeds in proportion to depth of zoom. When zooms speed is increasing, the camera moving speed becomes slow. When zooms speed is decreasing, the camera moving speed becomes fast.

1.2.6 On-screen Tips

Via menu, here you can view:

- Call preset and preset ID, speed dome title when calling touring.
- Dome system temperature.
- Dome address, direction.

1.2.7 Preset

Preset function is to save the address information (such as PTZ pan/tilt, focus and etc) to the memory so that you can quickly adjust the dome and PTZ to the correct position.

1.2.8 Auto Scan

Camera scans back and forth regularly in a horizontal field. Here you need to set left and right limit and scan speed.

1.2.9 Auto Tour

Add presets into a routine in a desired order and then set time and stop duration for each address. The dome will begin an auto touring between these presets.

1.2.10 Auto Pattern

Memorize dome operation such as pan, tilt, and zoom to repeat. You can call it to repeat the previous operation.

1.2.11 Privacy Masking

Privacy masking is a user-defined, four-sided area that can not be viewed by you. The masking area will move with pan and tilt functions and automatically adjust in size as the lens zooms.

1.2.12 Action on Alarm

There are 2 alarm inputs (NO/NC) and 1 NO outputs. Alarms can be individually programmed to initiate an associated operation when received.

1.2.13 Auto Flip

As long as you continue to hold the keyboard joystick in the down position, the dome rotates 180 degrees and repositions itself for uninterrupted viewing of any subjects that passes directly beneath the dome.

1.2.14 Self-diagnosis

There is a self diagnosis procedure when dome boots up.

- Tilt and vertical engine check
- Camera diagnosis

1.2.15 Day/Night Mode (B/W & Color Mode)

There are several modes such as auto/color/B&W. This function needs the speed dome driver (camera) supported.

1.2.16 Auto Focus

Support auto focus function.

1.2.17 Backlight Compensation

Balance the brightest and darkest sections of a scene to produce a more vivid picture.

1.2.18 Pan Tilt and Zoom

Supports zoom in and zoom out during tilt and pan movement.

In this period auto focus and auto iris can still get vivid image.

1.2.19 3D Intelligent Location

Support 3D intelligent positioning function, speed dome can auto track to the specified zone. .

1.2.20 Idle Status

When there is no available order for specified period, the speed dome can implement previously set idle operation.

1.2.21 Power up

The speed dome executes the power up operation after it rebooted and completed the initialization. The power up function includes auto, preset, scan, tour, pattern and none.

1.2.22 Image Flip

You can enable image flip in the menu. The flip function allows you to view continuous video.

This function needs the speed dome driver (camera) supported.

2 Preparation Works

These series products support two control modes: Serial/HD-AVS.

- For HD-AVS series product, please select control mode as HD-AVS. The control signal is sent to the PTZ via the coaxial cable.
- For the serial mode, the control signal is sent to the PTZ via the RS485 port.

2.1 HD-AVS

Important

If you want to control the speed dome via the coaxial cable, you need to use the corresponding HD-AVS DVR.

Please go to the PTZ setup interface of the DVR and then set the control mode as HD-AVS and the protocol as ICR-SD1. You do not need to set address and the baud rate. See Figure 2-1.

Please refer to the HD-AVS series DVR user's manual for detailed information.

After the setup, please connect the DVR to the speed dome via the video cable. Now you can control the speed dome.

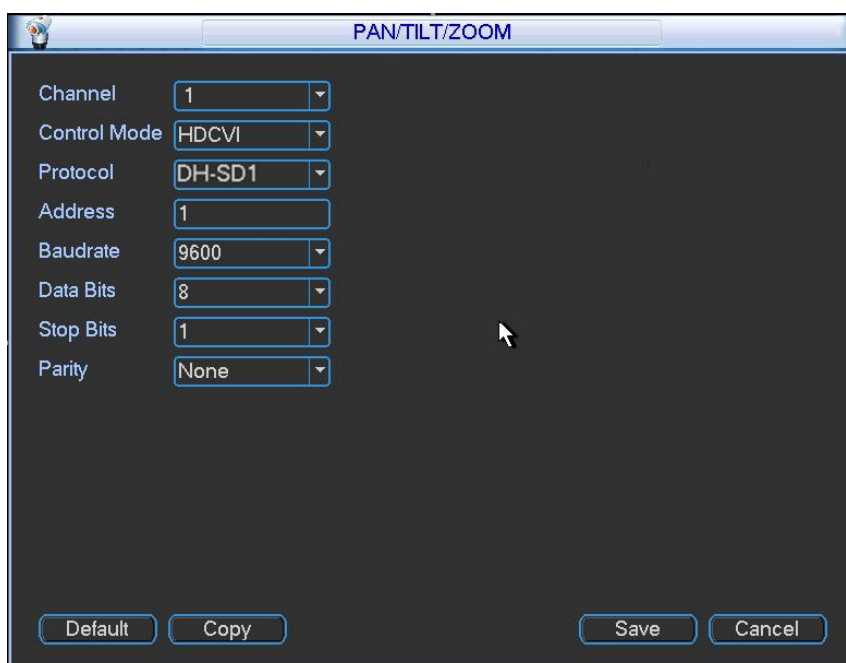

Figure 2-1

2.2 Serial

If you want to control the speed dome via the serial port, please set the control mode as serial. The address, baud rate and parity value shall be the same as the dial switch of the speed dome. Otherwise, you can not control the speed dome.

2.2.1 Protocol/Baud Rate /Address Setup

Important

If you are using HD-AVS series DVR to control the speed dome, you can skip this chapter.

Before you use serial port to control the speed dome, you need to follow the contents listed below to set address, baud rate, parity and etc. Otherwise, you can not control the device.

Open the transparent enclosure, there are two dial switch buttons on the PCB of one side of the speed dome (There are labels.). You can use them to set speed dome protocol, baud rate, address and etc. See Figure 2-2 .

After setup, you need to click on-off button or go to the OSD menu to select restart option to reboot the device to activate new setup.

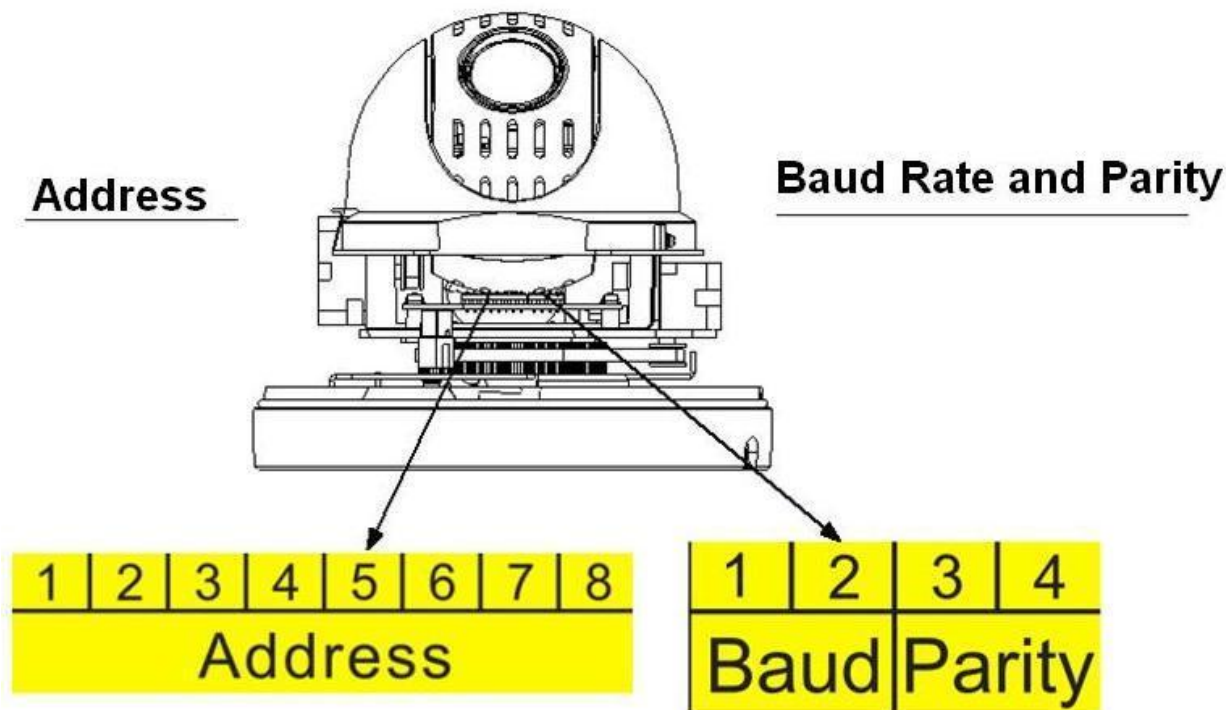

Figure 2-2

2.2.2 Baud Rate and Parity

Please note the IR speed dome can automatically recognize the industrial standard protocol, PELCO-D. PELCO-P. Usually you do not need to set the protocol.

The interface is shown as in Figure 2-3.

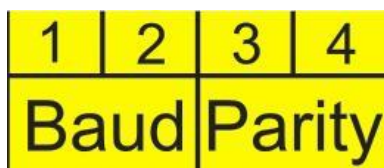

Figure 2-3

Please refer to the baud rate sheet for detailed information.

1	2	Baud Rate
OFF	OFF	9600bps
ON	OFF	4800bps
OFF	ON	2400bps
ON	ON	1200bps

Please refer to the parity sheet for detailed information.

3	4	Parity
OFF	OFF	NONE
ON	OFF	EVEN
OFF	ON	ODD
ON	ON	NONE

2.2.3 Set address dial switch

The encode mode adopts binary system. 1 to 8 is the valid bit. The highest address bit is 255. See Figure 2-4.

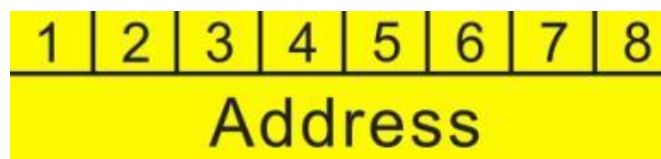

Figure 2-4

You can refer to the following sheet for more information.

Address	1	2	3	4	5	6	7	8
1	OFF	OFF	OFF	OFF	OFF	OFF	OFF	OFF
1	ON	OFF	OFF	OFF	OFF	OFF	OFF	OFF
2	OFF	ON	OFF	OFF	OFF	OFF	OFF	OFF
3	ON	ON	OFF	OFF	OFF	OFF	OFF	OFF
4	OFF	OFF	ON	OFF	OFF	OFF	OFF	OFF
5	ON	OFF	ON	OFF	OFF	OFF	OFF	OFF
6	OFF	ON	ON	OFF	OFF	OFF	OFF	OFF
7	ON	ON	ON	OFF	OFF	OFF	OFF	OFF
8	OFF	OFF	OFF	ON	OFF	OFF	OFF	OFF
.....							
254	OFF	ON	ON	ON	ON	ON	ON	ON
255	ON	ON	ON	ON	ON	ON	ON	ON

3 Menu

3.1 Screen Menu Index

Note:

ERR means current setup is invalid.

... means there is submenu.

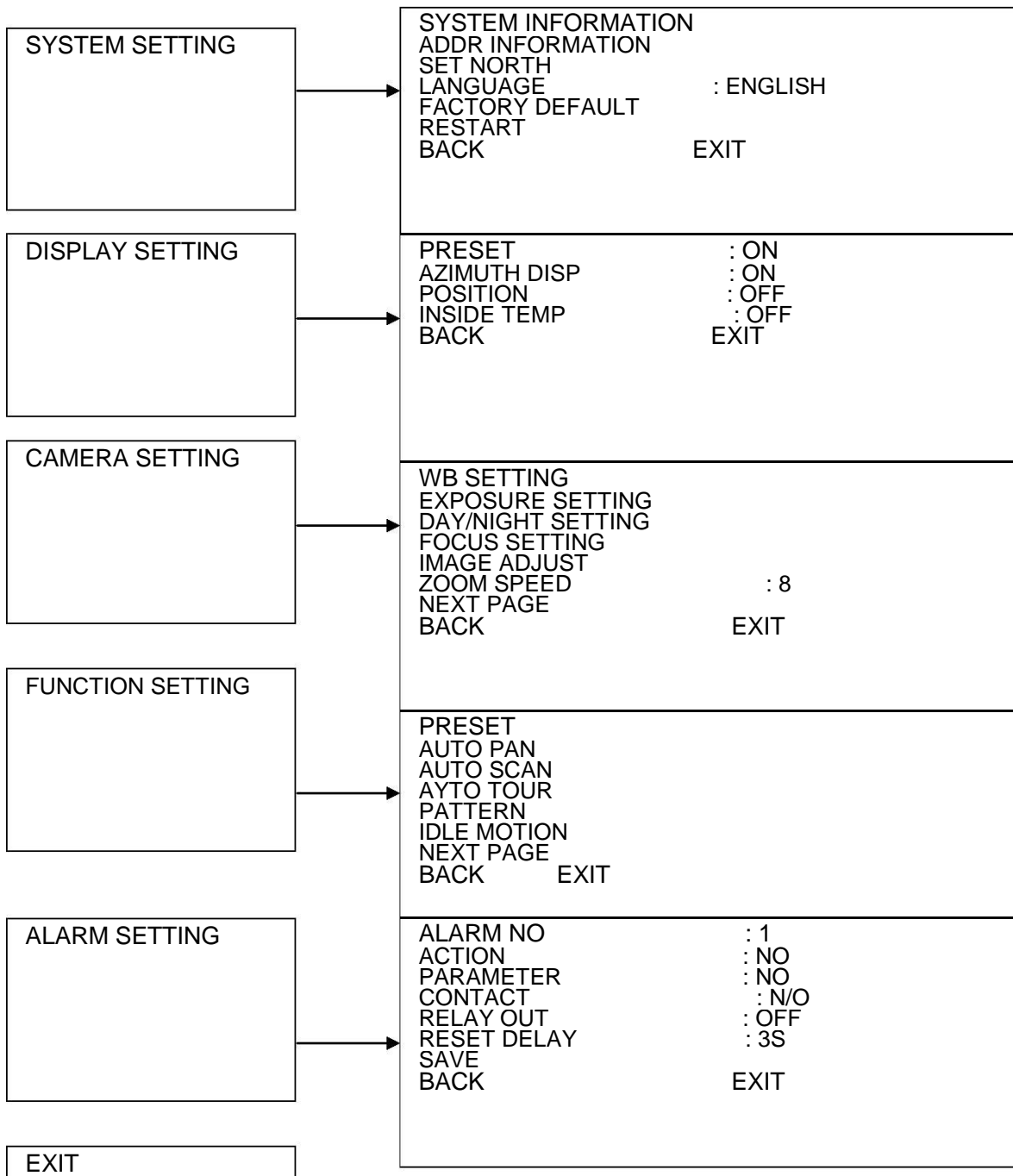

The above diagram illustrates the overall structure of the speed dome setup menu.

Note:

- ERR means current setup is invalid. Please restore factory default setup.
- Please make sure all the cable connections are right.

3.2 Self-diagnosis System Information

ADDR	:001-H
BR	:9600
PARITY	:None
VERSION	:V1.00.0.R

Figure 3-1 Self-diagnosis

After installation, please connect speed dome to power. The system goes on a self-diagnosis, and then it pops up the above interface to show the system information.

The above interface disappears after speed dome received the first command (or the display time lasts for 4 minutes.)

- ADDR: Here you can view dome address information. For example, 001-H, -H is the hardware address number, -S is software address mode.
- BR: Dome communication baud rate.
- PARITY: Communication parity bit format.
- VERSION: Dome software version.

When you are using the control keyboard or the matrix host to control the device, please make sure the control parameter of the keyboard or the matrix host is the same with the speed dome OSD (including address, baud rate, parity). Please make sure the cable connection is OK.

3.3 Main Menu

You can open speed dome menu via control keyboard, matrix, or speed dome control terminal.

SYSTEM SETTING
DISPLAY SETTING
CAMERA SETTING
FUNCTION SETTING
ALARM SETTING
EXIT

Figure 3-2 Main menu

- SYSTEM SETTING: Dome system information, address information, system time, set north direction, language, factory default setup, and restart and so on.
- DISPLAY SETTING: Display dome preset, azimuth display, direction, and dome internal temperature and etc information.
- CAMERA SETTING: Display dome white balance setup, exposure setup, day/night setup, focus setup, image adjustment, zoom speed, aperture setup, aperture restrain level, digital zoom, image flip, image output mode, factory default setup, camera restart and etc.
- FUNCTION SETTING: Set preset, auto pan, auto scan, auto tour, auto pattern, idle motion, privacy mask and etc.
- ALARM SETTING: Set dome alarm number, action, parameter, contact, replay out, reset time and etc.
- EXIT: Log out the system menu.

3.4 Menu Operation

In the speed dome main menu, you can use the left/right button on the keyboard or in the speed dome terminal menu to configure the system menu. Before setup, please move the cursor to the current item you want to configure.

- In main menu, please click confirm button to go to the sub menu or use left/right key to configure setup.
- Use up/down button to select back option and then click confirm button to go back to the previous menu.
- Use up/down button to select exit option and then click confirm button to log out system menu.
- All setup here will not lose when encounter power failure.

3.4.1 System Setting

```
SYSTEM INFORMATION
ADDR INFORMATION
SET NORTH
LANGUAGE           : ENGLISH
FACTORY DEFAULT
RESTART
BACK               EXIT
```

Figure 3-3 System setting

- **SYSTEM INFORMATION:** Move the cursor to SYSTEM INFORMATION and then click confirm button to go to the third submenu.
- **ADDR INFORMATION:** Move the cursor to SITE INFORMATION and then click confirm button to go to the third submenu.
- **SET NORTH:** Set dome benchmark direction so that you can know the angel between the benchmark and then current location. Please move the cursor to the option and then click confirm button until you see O.K. Now you have set north direction.
- **LANGUAGE:** The dome menu language. There are several languages for you to select. Please use the left/right button on the keyboard or in the speed dome terminal menu to set.
- **FACTORY DEFAULT:** Restore dome factory default setup. Please move the cursor to the option and then click confirm button until you see O.K. Now you can see the IP dome begin rebooting to restore factory default setup.
- **RESTART:** Reboot the speed dome.
- **BACK:** Go back to the previous menu.
- **EXIT:** Log out system menu.

3.4.1.1 System information

```
ADDR           : 001
BAUD RATE      : 9600
PARITY         : NONE
SOFTWARE       : V1.00.0.RHCJEK
BACK           EXIT
```

Figure 3-4 System information

Move the cursor to SYSTEM INFORMATION and then click confirm button, you can see the above interface.

Here you can view dome basic information.

3.4.1.2 Address Information

ADDR TYPE	:HARD
ADDR-HARD	:1
ADDR-SOFT	:0
BACK	EXIT

Figure 3-5 Address information

Move the cursor to SITE INFORMATION and then click confirm button.

- ADDR TYPE: There are two options: soft and hard. Please use the left/right button on the keyboard or in the speed dome terminal menu to set.
- ADDR-HARD: It is an address you set in the dial switch. You can not modify it through software.
- ADDR-SOFT: You can set address via software. It is to say, you can use menu to modify dome address.
- BACK: Go back to the previous menu.
- EXIT: Log out system menu.

3.4.2 Display Setting

PRESET TITLE	:ON
AZIMUTH DISP	:ON
POSITION	:OFF
INSIDE TEMP	:°C
BACK	EXIT

Figure 3-6 Display setting

Move the cursor to DISPLAY SETUP and then click confirm button, you can go to the third submenu. Please use the left/right button on the keyboard or in the speed dome terminal menu to set. After completed setup, please click save button to save current setup.

- PRESET: Display dome preset title or not. Please use the left/right button on the keyboard or in the speed dome terminal menu to set. You can go to Function Setup->Preset section to set corresponding preset value and preset title.
- AZIMUTH DISP: Display dome current coordinates or not. Please use the left/right button on the keyboard or in the speed dome terminal menu to set.
- POSITION: Display the angel between the benchmark and then current location. Please use the left/right button on the keyboard or in the speed dome terminal menu to set.
- INSIDE TEMPERATURE: Display dome internal temperature or not. There are three options: °C /F/Off. Please use the left/right button on the keyboard or in the speed dome terminal menu to set.
- BACK: Go back to the previous menu.
- EXIT: Log out system menu.

3.4.3 Camera Setting

WB SETTING	
EXPOSURE SETTING	
DAY/NIGHT SETTING	
FOCUS SETTING	
IMAGE ADJUST	
ZOOM SPEED	:8
NEXT PAGE	
BACK	EXIT

Figure 3-7 Camera setting

APERTURE	:9
APERTURE RESTRAIN	:10
DIGITAL ZOOM	:OFF
PICTUER FLIP	:OFF
LENS INITIALIZATION	
PICTURE MODE	:720P/25
NEXT PAGE	
BACK	EXIT

Figure 3-8 Next page

Figure 3-10 White balance

Move the cursor to WHITE BALANCE MODE and then click confirm button, you can go to the submenu.

- WHITE BALANCE MODE: Set white balance adjustment mode. There are several modes such as auto, ATW, indoor, outdoor, and manual and etc. Please use the left/right button on the keyboard or in the speed dome terminal menu to set.
- R GAIN: Before you set R GAIN option, please note the mode is manual. Please use the left/right button on the keyboard or in the speed dome terminal menu to set.
- B GAIN: Before you set B GAIN option, please note the mode is manual. Please use the left/right button on the keyboard or in the speed dome terminal menu to set.
- BACK: Go back to previous menu.
- EXIT: Log out system menu.

3.4.3.2 Exposure Setting

AE MODE	:AUTO
GAIN SETTING	:2
SHUTTER	: 1/50
IRIS SETTING	:4
EXPOSURE COMP	:8
SLOW SHUTTER	:ON
NEXT PAGE	
BACK	EXIT

Figure 3-11 Exposure setting

AGC GAIN LIMIT	:2
SLOW SHUTTER LIMIT	:1/25
NOISE REDUCTION	:3
3D NOISE REDUCTION	:OFF
BLC	:OFF
WDR SETTING	
NEXT PAGE	
BACK	EXIT

Figure 3-12 Next page

HIGH LIGHT REDUCE	:OFF
AE RECOVERY	:15M
BACK	EXIT

Figure 3-13 Next page

- AE MODE: Here you can set the camera exposure mode. It includes: auto/manual/AV (iris priority)/TV (shutter priority). Please use the left/right button on the keyboard or in the speed dome terminal menu to set.
 - Auto: The gain, iris, shutter are in auto mode.
 - Manual: You need to set the gain setting, shutter, and iris setting manually.
 - Shutter Priority (TV): It is for you to set the shutter manually, Gain and iris are in auto mode.
- GAIN SETTING: It is to set camera gain. Please use the left/right button on the keyboard or in the speed dome terminal menu to set.
- SHUTTER: It is to set camera shutter. Please use the left/right button on the keyboard or in the speed dome terminal menu to set.
- IRIS SETTING: It is to set camera iris. Please use the left/right button on the keyboard or in the speed dome terminal menu to set.
- EXPOSURE COMP: It is to set camera exposure compensation. Please use the left/right button on the keyboard or in the speed dome terminal menu to set.
- SLOW SHUTTER: In lower illumination environment, you can lower the cameras auto exposure time to capture the image and enhance the definition. Please use the left/right button on the keyboard or in the speed dome terminal menu to set.
- NEXT PAGE: It includes: AGC GAIN LIMIT, SLOW SHUTTER LIMIT, NOISE REDUCTION, 3D NOISE REDUCTION, BLC, HIGH LIGHT REDUCE, WDR, AE RECOVERY, BACK, and EXIT. Move the cursor to the item and then click the left/right button to set.

- AGC GAIN LIMIT: It is to set auto gain high limit. Please click the left/right button to set.
- SLOW SHUTTER LOW LIMIT: Please click the left/right button to set.
- NOISE REDUCTION: There may noise when the camera is monitoring the low illumination environments. You can use the digital filter to process the noise to guarantee the clear video.
- 3D NOISE REDUCTION: It is to set the speed dome 3D noise reduction setup. Please use the left/right button on the keyboard or in the speed dome terminal menu to set.
- BLC: It is an abbreviation for back light compensation. System can compensate the object in the dark light to achieve a clear video. Please use the left/right button on the keyboard or in the speed dome terminal menu to set.
- WDR SETTING: Please make sure your camera supports current function. It includes WDR mode, detection sensitivity, shadow correction and etc. Move the cursor to current item and then click the OK button to go to the fourth level menu. Please use the left/right button on the keyboard or in the speed dome terminal menu to set.
- NEXT PAGE: It includes: HIGH LIGHT REDUCE, AE RECOVERY. Move the cursor to the item and then click the left/right button to set.
- HIGH LIGHT REDUCE: It is to adjust image whole brightness to restrain the extra high brightness section to get vivid video. Please click the left/right button to set on/off.
- AE RECOVERY: Manually click the “+” and “-“button on the PTZ interface, system can resume previous exposure value after specified time (The exposure value does not resume if this function is off.).

- BACK: Go back to previous menu.
- EXIT: Log out system menu.

3.4.3.3 WDR

Move the cursor to WDR and then click confirm button, you can go to the submenu.

WDR MODE	: OFF
BACK	EXIT

Figure 3-14 WDR

- WDR MODE: Please make sure your purchased camera support this function. System can auto adjust image brightness when there is a harsh contrast between image dark and bright section. Please use the left/right button on the keyboard or in the speed dome terminal menu to set on/off/auto.
- BACK: Go back to previous menu.
- EXIT: Log out system menu.

3.4.3.4 Day/Night Setting

Move the cursor to DAY/NIGHT SETTING and then click confirm button, you can go to the submenu.

DAY/NIGHT	: AUTO
THRESHOLD	: 4
DAY/NIGHT TYPE	: ELECTRONIC
SAVE	
BACK	EXIT

Figure 3-15 Day/night setting

- DAY/NIGHT: It is to set camera day/night switch mode. Please use the left/right button on the keyboard or in the speed dome terminal menu to set.
- THRESHOLD: The speed dome can switch the day/night mode when it reached the threshold you set here.
- DAY/NIGHT MODE: It is to set day/night switch mode. Click left/right button to set.
- SAVE: This button is for DAY TIME and NIGHT TIME setup. After you set the day time (or night time), you need to move the cursor here and then click confirm button to save current time setup. For other setups, you do not need to use this button.
- BACK: Go back to previous menu.
- EXIT: Log out system menu.

3.4.3.5 Focus Setting

FOCUS MODE	: AUTO
FOCUS LIMIT	: 10CM
AF SENSITIVITY	: NORMAL
IR CORRECTION	: ATUO
BACK	EXIT

Figure 3-16 Focus setting

- FOCUS MODE: It is to set the camera focus mode. It includes several modes such as auto, manual, semiautomatic. Please use the left/right button on the keyboard or in the speed dome terminal menu to set.
- FOCUS LIMIT: It is to set the camera focus limit. Please use the left/right button on the keyboard or in the speed dome terminal menu to set.
- AF SENSITIVITY: It is to set the camera focus sensitivity. Please use the left/right button on the keyboard or in the speed dome terminal menu to set.
- IR CORRECTION: It is to set the camera IR light focus correction. Please use the left/right button on the keyboard or in the speed dome terminal menu to set.
- BACK: Go back to previous menu.
- EXIT: Log out system menu.

3.4.3.6 Image Adjust

Move the cursor to IMAGE ADJUST and then click confirm button to go to the submenu to set.

HUE	:50
BRIGHTNESS	:50
SATURATION	:50
CHROMA SUPPRESS	:01
GAMMA	:01
CONTRAST	:50
STYLE	:STANDARD
BACK	EXIT

Figure 3-17 Image Adjust

- HUE: It is to set picture hue. Please use the left/right button on the keyboard or in the speed dome terminal menu to set.
- BRIGHTNESS: It is to set picture brightness. Please use the left/right button on the keyboard or in the speed dome terminal menu to set.
- SATURATION: It is to set picture saturation. Please use the left/right button on the keyboard or in the speed dome terminal menu to set.
- CHROMA SUPPRESS: It is to set picture color control. Please use the left/right button on the keyboard or in the speed dome terminal menu to set.

- GAMMA: It is to set picture gamma. It includes the fourth menu. Move the cursor to current item and then click confirm button to go to the submenu.
- CONTRAST: It is to set picture color contrast. Please use the left/right button on the keyboard or in the speed dome terminal menu to set.
- STYLE: It is to set video style. Please use the left/right button on the keyboard or in the speed dome terminal menu to set.
- BACK: Go back to previous menu.
- EXIT: Log out system menu.

3.4.4 Function Setting

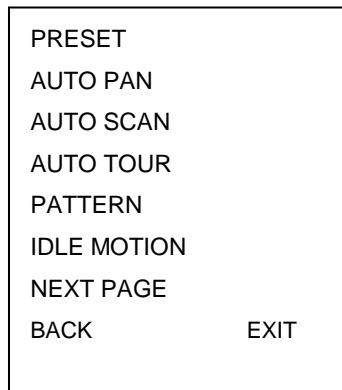

Figure 3-18 Function setting

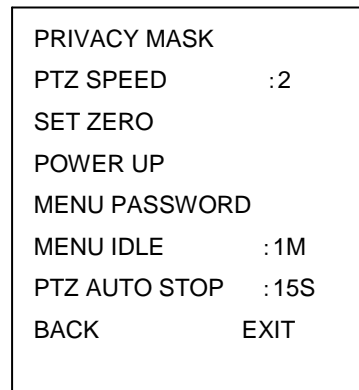

Figure 3-19 Next page

Please go back to main menu and move the cursor to FUNCTION SETTING, click confirm button. You can see the above interface.

- PRESET: It is to set preset. Move the cursor to PRESET and then click confirm button to go to the third submenu.
- AUTO PAN: It is to set pan. Move the cursor to AUTO PAN and then click confirm button to go to the third submenu.
- AUTO SCAN: It is to set scan number, speed and etc. Move the cursor to AUTO SCAN and then click confirm button to go to the third submenu.
- AUTO TOUR: It is to set tour number, tour operation and etc. Move the cursor to AUTO TOUR and then click confirm button to go to the third submenu.
- PATTERN: It is to set pattern number and etc. Move the cursor to AUTO PATTERN and then click confirm button to go to the third submenu.
- IDLE MOTION: It is to set idle operation, idle time and etc. Move the cursor to IDLE MOTION and then click confirm button to go to the third submenu.
- NEXT PAGE: It includes: PRIVACY MASK, PTZ SPEED, SET ZERO, POWER UP and etc. Move the cursor to the item and then click the confirm button to set.
- PRIVACY MASK: Here you can set the privacy mask number and etc. It includes the third menu. Please move the cursor to the current item and then click the confirm button to go to the next interface.
- PTZ SPEED: It is to set PTZ speed. Please use the left/right button to set.
- SET ZERO: Please move the PTZ to the horizontal coordinates, click OK button to confirm.
- POWER UP: It is to set the PTZ action when the speed dome boots up. Click the confirm button to go to the next interface to set.
- MENU PASSWORD: It is to set menu password. Move the cursor to MENU PASSWORD and then click confirm button to go to the next submenu to set.

- MENU IDLE: If current setup is ON, once you open the menu and leave it idle for specified period, the menu may automatically disappear. If current setup is OFF, the menu is always there and will not disappear. Please use the left/right button to set.
- PTZ AUTO STOP: The speed dome will stop all the PTZ operations when there is no command for the specified time. It includes various setups. Please use the left/right button to set.
- BACK: Go back to previous menu.
- EXIT: Log out system menu.

3.4.4.1 Preset

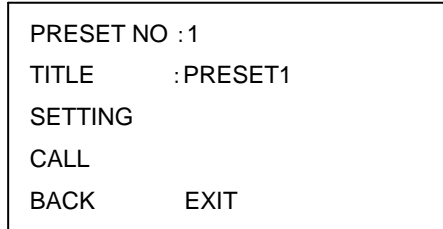

Figure 3-20 Preset setting

Move the cursor to PRESET button and then click confirm button to go to set interface.

- PRESET NO: Please use left/right key to modify preset number. The different protocols support different preset values.
- TITLE: Title text is the label used for you to identify the camera. System will automatically name a title for the camera.
- SETTING: Please input preset number first and then select the monitor zone. Please move the cursor to setting and click confirm button. The system will pop up a message: PRESET: ***. Here *** means preset number. And the SETTING column pops up an OK. Now you successfully added a preset. Please note, you need to enable display preset title function first (Main menu->display setting->preset title). Repeat the above procedures to set more presets. Once you want to modify a preset, you can input the preset number you want to modify and then follow the above steps to set the preset. You can successfully modify a preset content.
- CALL: Here is to call preset. Move the cursor to PRESET NO and then input corresponding preset value. Then move the cursor to CALL and then click confirm button to go to a preset.
- BACK: Go back to previous menu.
- EXIT: Log out system menu.

For PELCO protocol user, please refer to the following special functions:

- **Call preset:** Call preset 28 or preset 95 to go to dome menu. Call preset 29 or preset 99 to go to scan. Call preset 24 or preset 81 to go to pattern. Call preset 25 or preset 82 to go to tour. Call preset 30 or preset 96 to stop scan or pattern. Call preset 31 or preset 83 to begin rotation. Call preset 33 to enable PTZ 180 degrees rotation. Call preset 34 to set dome position as 0.
- **Set preset:** Set preset 26 or 92 to set scan left limit. Set preset 27 or 93 to set scan right limit. Set preset 22 or 79 to begin record. Set preset 23 or 80 to stop record.

3.4.4.2 Pan

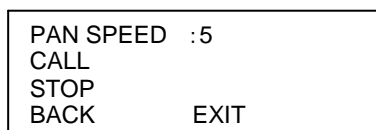

Figure 3-21 Pan setting

Move the cursor to PAN button and then click confirm button to go to setup interface.

- PAN SPEED: Set dome rotation speed. Please use the left/right button on the keyboard or in the speed dome terminal menu to set.
- CALL: Move the cursor to CALL item and then click confirm button. The dome begins 360 degrees continuous rotation.
- STOP: Highlight stop item and then click confirm button. The dome stops rotation.
- BACK: Go back to previous menu.
- EXIT: Log out system menu.

3.4.4.3 Auto Scan

AUTO SCAN NO	: 1
SET LEFT LIMIT	
SET RIGHT LIMIT	
SCAN SPEED	:5
CALL	
STOP	
BACK	EXIT

Figure 3-22 Auto scan setting

Move the cursor to SCAN button and then click confirm button.

- AUTO SCAN NO: Here is to set auto scan number. Please use the left/right button on the keyboard or in the speed dome terminal menu to set.
- SET LEFT LIMIT: Here is to set camera left address. Click confirm button to save current setup.
- SET RIGHT LIMIT: Here is to set camera right address. Click confirm button to save current setup.
- SCAN SPEED: Please use the left/right button on the keyboard or in the speed dome terminal menu to set.
- CALL: Please input auto scan number first, and then please move the cursor to CALL and click confirm button to activate auto scan function.
- STOP: Here is to terminate auto scan function.
- BACK: Go back to previous menu.
- EXIT: Log out system menu.

3.4.4.4 Auto Tour

TOUR NO:	: 1
TOUR SETTING	
DELETE TOUR	
CALL	
STOP	
BACK	EXIT

Figure 3-24 Tour setting

Move the cursor to highlight TOUR item and then click confirm button to go to set interface.

- TOUR NO : Here is to set tour number. Please use the left/right button on the keyboard or in the speed dome terminal menu to set.
- TOUR SETTING: Move the cursor to TOUR setting item and then click confirm button. You can see the following interface. Here you can add or remove the preset, and set the corresponding dwell time and call speed.

NO	PRESET	DWELL	SPEED
01	000	005	013
02	000	005	013
03	000	005	013
...
32	000	005	013
	BACK	EXIT	

Figure 3-25 Tour setting-2

- DWELL: Here is to set dwell time. Please use the left/right button on the keyboard or in the speed dome terminal menu to set.
- SPEED: Here you can set the speed value.

When you move the cursor to one tour number, you can use left/right button to turn the page.

When you move the cursor to one tour number, please click confirm button to set the tour. Please use up/down button to set preset number, dwell time and speed. Use the left/right button to go to the next tour. Click confirm button you can exit the setup. After you completed the setup, move the cursor to back button to go to the previous interface.

- DELETE TOUR : Here is to delete a tour. Input tour number in TOUR NO and then move the cursor to DELETE TOUR, click confirm button to delete.
- CALL: Here is to activate tour. Input tour number in tour NO and highlight CALL, click confirm button to activate tour.
- STOP: Here is to terminate touring.
- BACK: Go back to previous menu.
- EXIT: Log out system menu.

3.4.4.5 Pattern

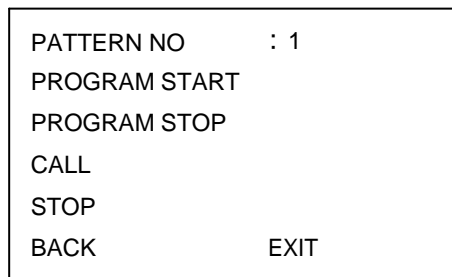

Figure 3-26 Pattern setting

Pattern function can memory PTZ operation and camera focus zoom in and zoom out. From the start position, dome begins auto movement repeatedly.

This series IP dome supports maximum 5 patterns and one pattern can max support 400 commands. Move the cursor to PATTERN and click confirm button.

- PATTERN NO: Here is to set pattern number. Please click left/right key to configure.
- PROGRAM START: Here is to memorize pattern starting point. An icon OK pops up in screen to prompt you system begins memory pattern.
- PROGRAM STOP: Here is to set pattern stop point. After all the movement, move the cursor to PROGRAM STOP and then click confirm button. Now you have set one pattern. System pops up an icon OK to prompt you system has memories one pattern.
- CALL: Here is to activate pattern. Input pattern number, move the cursor to CALL and click confirm button, system begins running pattern.
- STOP: Here is to stop current pattern. Input pattern number, move the cursor to STOP and click confirm button. System stops current pattern.
- BACK: Go back to previous menu.
- EXIT: Log out system menu.

Note:

- The dwell time between two orders should be less than one minute, otherwise system will set to default value as one minute.
- After click PROGRAM STOP, do not click CALL button before icon “●” disappears completely.

Any manual operation during the pattern procedure will terminate current dome pattern operation.

3.4.4.6 Idle Motion

IDLE MOTION	: OFF
IDLE TIME	: 10MIN
IDLE MOTION	: NONE
PARAMETER	: NONE
BACK	EXIT

Figure 3-27 Idle motion

When there is no available command for specified time, dome automatically goes on the previous set functions.

- IDLE MOTION: There are two modes ON/OFF. Please use left/right key to set.
- IDLE TIME: System idle period. Please use the left/right button on the keyboard or in the speed dome terminal menu to set.
- IDLE MOTION: There are several functions you can select: NONE/PRESET/SCAN/TOUR/PATTERN. Please use the left/right button on the keyboard or in the speed dome terminal menu to set.
- PARAMETER: It is to set idle motion SN. System can implement the corresponding action when it is idle for the specified period. Click the left/right button to set.
- SAVE: Move the cursor to SAVE and click confirm button to save current setup.
- BACK: Go back to previous menu.
- EXIT: Log out system menu.

3.4.4.7 Privacy Mask

Move the cursor to PRIVACY MASK and click confirm button, system goes to privacy mask setup interface.

PRIVACYNO	: 1
PRIVACY MASKING	: OFF
SETTING	
BACK	EXIT

Figure 3-28 Privacy mask

RESIZE	: ↑
SAVE	
BACK	EXIT

Figure 3-29 Privacy mask-2

Note:

- For security reasons, please set privacy zone a little bit larger than the privacy object size.
- Each time, after modifications you need to move the cursor to SAVE button and then click confirm button to get all setup activated. Otherwise, privacy zone may not move correspondingly with the object.

Please enter privacy mask menu. Move the cursor to PRIVACY NO, please use left/right key to set different privacy zones. For example, shift to 001 section and then move the cursor to PRIVACY MASKING.

Secondly, click OK button to go to the setup interface. Now there is a privacy zone in the screen centre. Operate PTZ to move the camera screen so that the centre of the object you want to shield is overlaying with the centre of the screen.

Thirdly, move the cursor to RESIZE and then click left and right key to adjust privacy zone direction and size. Move the cursor to SAVE and then click confirm button to exit. Please note you need to click SAVE button to save current privacy mask setup so that the privacy mask region can move along with the PTZ movement to always cover the object you want to shield.

- PRIVACY NO: Here is to set privacy mask zone. Please use the left/right button on the keyboard or in the speed dome terminal menu to set. You can call corresponding privacy mask zone number if you have successfully set one.
- PRIVACY MASKING: There are two settings: on and off. Please go to the corresponding privacy mask zone and click left/right button to set.
- RESIZE: It is to adjust the privacy zone size. Move the cursor to current item and use the left/right button on the keyboard or in the speed dome terminal menu to set. Please continue pressing direction button to widen or narrow zone size. ← is to narrow the horizontal width and → is to widen the horizontal width. ↑ is to widen vertical height and ↓ is to narrow the vertical height.
- SAVE: Here is to save user setup.
- BACK: Go back to previous menu.
- EXIT: Log out system menu.

3.4.4.8 Power Up

Move the cursor to the POWER UP item and then click the confirm button, you can go to the fourth menu.

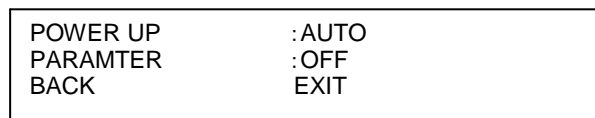

Figure 3-30 Power up

- POWER UP: It is to set the PTZ operation when the speed dome boots up. The option includes: NONE/AUTO/SCAN/PRESET/PATTERN/TOUR and etc. Please use the left/right button to set.
- PARAMETER: Here you can set the serial number of the corresponding operation such as the scan, preset, pattern, tour. Please use the left/right button to set.
- BACK: Go back to the previous menu.
- EXIT: Log out the system menu.

3.4.4.9 Menu Password

Move the cursor to the MENU PASSWORD and then click the confirm button to go to the fourth menu.

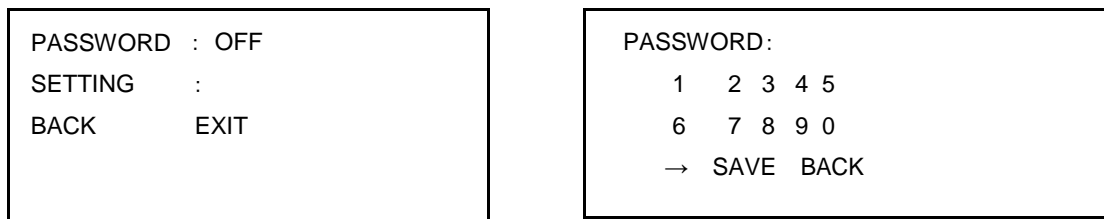

Figure 3-31 Password setting

- PASSWORD: Enable this function here so that you set password is valid. This function is on by default after you set password.
- SETTING: Click the confirm button to go to the password setup interface. Please use the left/right button to set the value and then click the confirm button to confirm current option. Move the cursor to the SAVE button and then click the confirm button to save current setup. Click the BACK button to go to the previous menu.
- BACK: Go back to the previous menu.
- EXIT: Log out the system menu.

If you have forgot your password. After three times of login failure, system may pop up an 8-digit internal code. Please contact our technical engineer for help.

3.4.5 Alarm Setting

ALARM NO	:1
ACTION	:NONE
PARAMETER	:NONE
CONTACT	:N/O
RELAY OUT	:OFF
RESET DELAY	:3S
SAVE	
BACK	EXIT

Figure 3-32 Alarm setting

Move the cursor to highlight ALARM SETTING button and then click confirm button.

- ALARM NO: Here is to set alarm input. Alarm input value ranges from 1 to 2. Please use the left/right button on the keyboard or in the speed dome terminal menu to set.
- ACTION: Action on alarm function. It includes NONE/PRESET/AUTO SCAN/TOUR functions. Please use the left/right button on the keyboard or in the speed dome terminal menu to set.
- PARAMETER: it is to set corresponding alarm operation such as scan/preset/tour. Please use the left/right button to set.
- CONTACT: You can set system activation operation once alarm occurred. There are two alarm signal mode: normal open (N/O) and normal closed (N/C). Please use the left/right button on the keyboard or in the speed dome terminal menu to set.
- RELAY OUT: Here is to set relay alarm mode and reset time. There are several options: off/1→5S.
✧ 1→5S: 1 means the first relay output.5S means the relay will reset automatically in five seconds after alarm occurs.
- RESET DELAY: Here is for you to set alarm reset time. Please use the left/right button on the keyboard or in the speed dome terminal menu to set: 3 seconds/10 seconds/30 seconds/60 seconds /120seconds. The dome will go back to previous setup after alarm acknowledgement.
- SAVE: Move the cursor to SAVE and then click confirm button to save current setup.
- BACK: Go back to previous menu.
- EXIT: Log out system menu.

3.5 Dome Abnormal Phenomenon Operation

3.5.1 Restore to Factory Default Setup

From main menu-> SYSTEM INFORMATION, move cursor to FACTORY DEFAULT and click confirm button. Dome will reboot and all the setups restore to factory default setup.

3.5.2 PTZ Movement is not smooth

From menu to SYSTEM INFORMATION, move cursor to RESTART and click confirm button. This reboot will not modify all activated setup (such as preset, tour and pattern)

3.5.3 Can not use coaxial cable to control the speed dome

From DVR main menu->setting->PTZ, check the control mode (HD-AVS) and the protocol (ICR-SD1). Click Save button to exit.

4 Cable Connection

4.1 Cable Connection

The speed dome combination cable includes video cable connection port, RS485 connection port, alarm input and output port, and power cable connection port. Please refer to the label for detailed information.

● Slight difference may be found in the port amount since some functions are optional.

Name		Function
485	A	485-A. It is to control dome built-in PTZ.
	B	485-B. It is to control dome built-in PTZ.
AC24V		24V power port. Connect to the power cable.
EARTH		Ground port.
HD-AVS		BNC port. HD-AVS standard signal to control the speed dome.
Audio	IN	Input audio
	GND	Audio GND port.

Sheet 4-1

Relay in/out interfaces is shown below:

Name	Function
Alarm out: 1	<ul style="list-style-type: none"> ● One alarm output channel. When there is an alarm from current channel, system activates relay or not. ● Alarm output relay default setup is NO. You can use the jump-cap near the power board relay to set. ● NO: Normal open alarm output. ● NC: Normal close alarm output.
Alarm out_com: 1	Alarm input ground end.
Alarm in: 1-2	<ul style="list-style-type: none"> ● Two alarm input channels. It is to receive relay signal from the external alarm source. You can go to dome menu to activate specified preset or patter. ● When the activation mode is NO (normal open), dome alarms when there is low voltage. High voltage will not activate the alarm. ● When the activation mode is NC (normal close), dome alarms when there is high voltage. Low voltage will not activate the alarm. <p>Note:</p> <ul style="list-style-type: none"> ● Dome alarm input message is ground mode. ● Dome alarm input signal are two modes: normal open and normal close.
GND	Alarm input ground end.

4.2 System Layout

4.2.1 System Connection

4.2.1.1 BUS connection

Please refer to Figure 4-1 for system connection information.

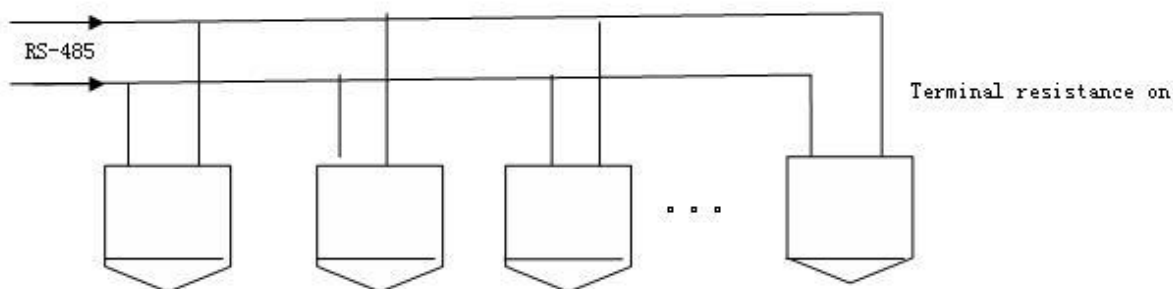

Figure 4-1

Note:

Please use shielded twisted pair. The shielded layer shall connect to GND firmly; otherwise it may affect communication or video work.

4.2.1.2 Star Connection

Please refer to Figure 4-2 for alarm connection information.

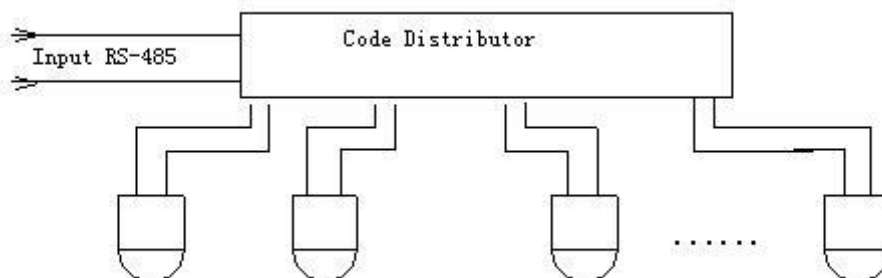

Figure 4-2

4.2.2 Alarm Connection

Please refer to Figure 4-3 for alarm connection information.

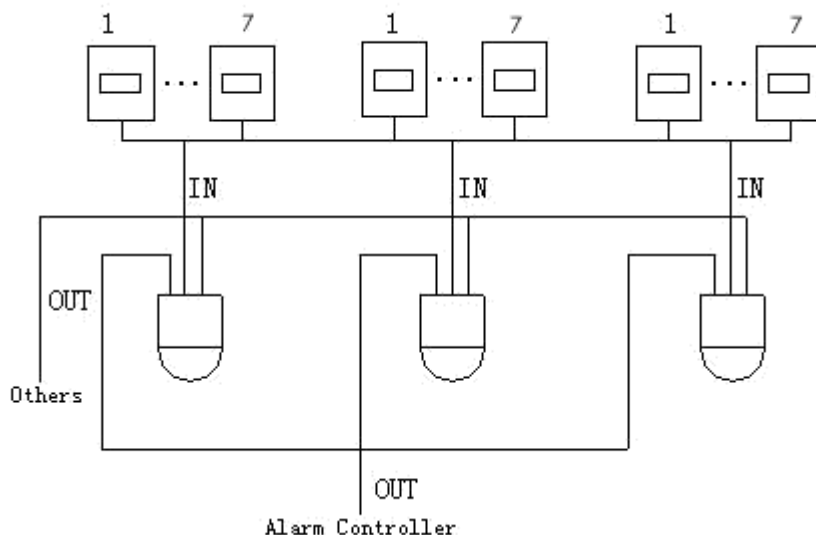

Figure 4-3

4.2.3 Keyboard Connection

This series HD-AVS speed dome supports keyboard operation. You can use keyboard to control the dome and PTZ. The display and control can work simultaneously. One keyboard can control maximum 255 speed domes. Please refer to Figure 4-4.

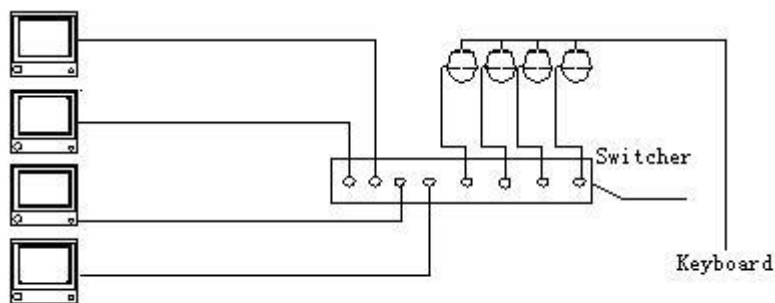

Figure 4-4

Speed dome protocol is open and supports multiple popular system platforms in today's market. Please contact us freely if some matrix systems do not support dome camera communication protocol. The most direct and easy way is to use current system to process video signal and add some control keyboards to control speed dome. See Figure 4-5.

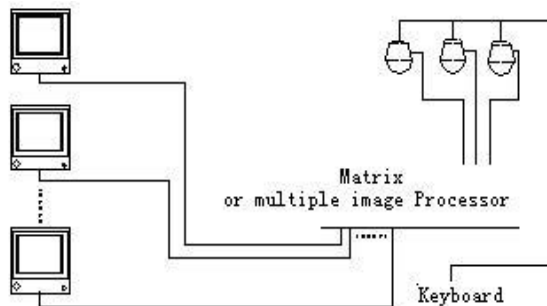

Figure 4-5

5 FAQ

5.1 Daily Maintenance

Please clean dome cover regularly to get vivid image.

Handle the cover with care. Use water to wash. Don't use cloth to clean.

Use mild detergent to clean if there is too much dust.

Note:

The sweat from your hand may erode plating surface, your nail may scrape dome cover result in blur image.

5.2 Problems and Solutions

SYMPTOM	CAUSE	SOLUTION
1) No self-diagnosis, no video signal when I connect dome to power.	Red LED is not on. <ul style="list-style-type: none"> • Your power supplying does not apply to the power. Or connection is too loose. • Power off or transformer problem. 	<ul style="list-style-type: none"> • Check power is connected or properly earthed. • Check power supply condition or check transformer.
	Red LED light on the power board is on <ul style="list-style-type: none"> • Power supplying is low • Something wrong with power board. 	<ul style="list-style-type: none"> • Use multimeter to check dome load. • Please contact retailer to replace power board.
2) No self diagnosis. There is a noise	Power supplying is inadequate.	Replace power supplying.
	Mechanical malfunction.	Need electrical engineer help.
3) Video signal loss occurs in high speed rotation.	Power supplying is not sufficient	Replace power supplying.
4) Video signal is not successive	Circuit connection is too loose.	Connect tightly.
	Video switch or power problem	Need electrical engineer help.
5) Video is not clear.	Focus is in manual mode.	Control manually.
	Dome cover is dirty.	Wash dome cover
6) During camera switch, there is a tilt movement in the monitor.	Camera power is not in the same Phase.	When several domes are connected to one transformer, please connect the transformer output cable to the domes' same side.

6 Appendix I Lightning Protection and Surge Protection

This series speed dome adopts TVS lightning protection technology. It can effectively prevent damages from various pulse signals below 4000V, such as sudden lightning and surge. While maintaining your local electrical safety code, you still need to take necessary precaution measures when installing the speed dome in the outdoor environment.

- The distance between the signal transmission cable and high-voltage device (or high-voltage cable) shall be at least 50 meters.
- Outdoor cable layout shall go under the penthouse if possible.
- For vast land, please use sealing steel tube under the land to implement cable layout and connects one point to the earth. Open floor cable layout is forbidden.
- In area of strong thunderstorm hit or near high sensitive voltage (such as near high-voltage transformer substation), you need to install additional high-power thunder protection device or lightning rod.
- The thunder protection and earth of the outdoor device and cable shall be considered in the building whole thunder protection and conform to your local national or industry standard.
- System shall adopt equal-potential wiring. The earth device shall meet anti-jamming and at the same time conforms to your local electrical safety code. The earth device shall not short circuit to N (neutral) line of high voltage power grid or mixed with other wires. When connect the system to the earth alone, the earth resistance shall not be more than 4Ω and earth cable cross-sectional area shall below 25 mm^2 . See Figure 6-1.

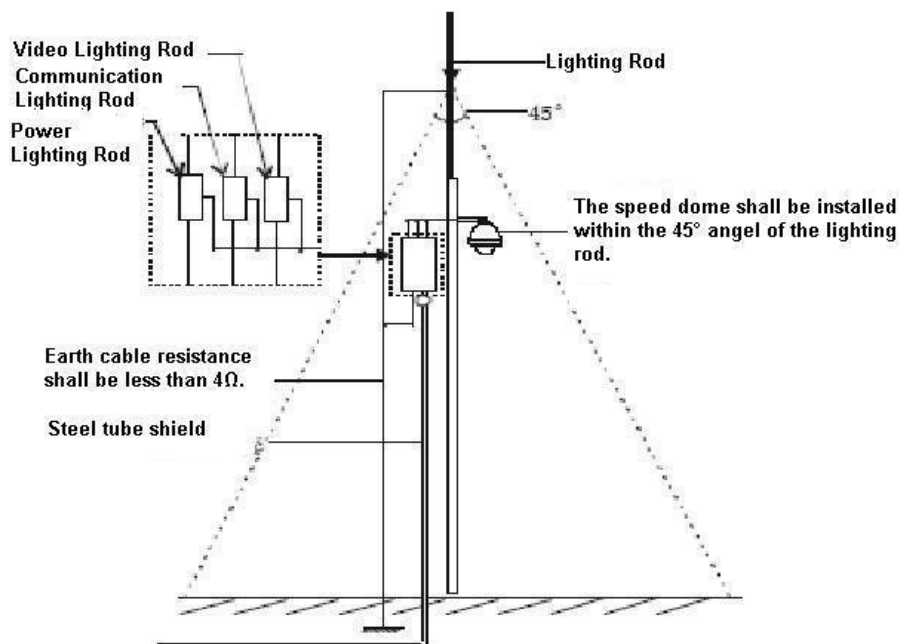
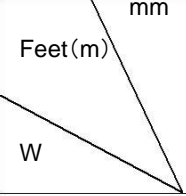

Figure 6-1

7 Appendix 2 The Relationship between the 24V AC Cable Diameter and the Transmission Distance

It is the recommended transmission distance when the cable diameter is fixed and the 24V AC power consumption is below 10%. For the AC device, the max permission voltage power consumption is 10%. For example, when a device of rated power 80VA installed from the transformer 35 inches (10m), then the min cable diameter is 0.8000mm.

	0.8000	1.000	1.250	2.000
10	283(86)	451(137)	716(218)	1811 (551)
20	141(42)	225 (68)	358 (109)	905 (275)
30	94 (28)	150 (45)	238 (72)	603 (183)
40	70 (21)	112 (34)	179 (54)	452 (137)
50	56 (17)	90(27)	143 (43)	362 (110)
60	47 (14)	75(22)	119 (36)	301 (91)
70	40 (12)	64(19)	102 (31)	258 (78)
80	35 (10)	56(17)	89 (27)	226 (68)
90	31(9)	50(15)	79 (24)	201 (61)
100	28(8)	45(13)	71 (21)	181 (55)
110	25(7)	41(12)	65 (19)	164 (49)
120	23(7)	37(11)	59 (17)	150 (45)
130	21(6)	34(10)	55 (16)	139 (42)
140	20(6)	32 (9)	51 (15)	129 (39)
150	18(5)	30 (9)	47 (14)	120 (36)
160	17(5)	28 (8)	44 (13)	113 (34)
170	16(4)	26 (7)	42 (12)	106 (32)
180	15(4)	25 (7)	39 (11)	100 (30)
190	14(4)	23 (7)	37 (11)	95 (28)
200	14(4)	22 (6)	35 (10)	90 (27)

8 Appendix 3 Wire Gauge Reference Sheet

Metric bare wire diameter (mm)	AWG	SWG	Bare wire cross section (mm ²)
0.050	43	47	0.00196
0.060	42	46	0.00283
0.070	41	45	0.00385
0.080	40	44	0.00503
0.090	39	43	0.00636
0.100	38	42	0.00785
0.110	37	41	0.00950
0.130	36	39	0.01327
0.140	35		0.01539
0.160	34	37	0.02011
0.180	33		0.02545
0.200	32	35	0.03142
0.230	31		0.04115
0.250	30	33	0.04909
0.290	29	31	0.06605
0.330	28	30	0.08553
0.350	27	29	0.09621
0.400	26	28	0.1257
0.450	25		0.1602
0.560	24	24	0.2463
0.600	23	23	0.2827
0.710	22	22	0.3958
0.750	21		0.4417
0.800	20	21	0.5027
0.900	19	20	0.6362
1.000	18	19	0.7854
1.250	16	18	1.2266
1.500	15		1.7663
2.000	12	14	3.1420
2.500			4.9080
3.000			7.0683

9 Appendix 4 Toxic or Hazardous Materials or Elements

Component Name	Toxic or Hazardous Materials or Elements					
	Pb	Hg	Cd	Cr VI	PBB	PBDE
Sheet Metal	○	○	○	○	○	○
Plastic Parts	○	○	○	○	○	○
PCB	○	○	○	○	○	○
Housing	○	○	○	○	○	○
Camera Driver	○	○	○	○	○	○
Bearing	○	○	○	○	○	○
Connection Cable	○	○	○	○	○	○
Motor (If possible)	○	○	○	○	○	○
Power (If possible)	○	○	○	○	○	○
Bracket (If possible)	○	○	○	○	○	○
Accessories	○	○	○	○	○	○

Note

O: Indicates that the concentration of the hazardous substance in all homogeneous materials in the parts is below the relevant threshold of the SJ/T11363-2006 standard.

X: Indicates that the concentration of the hazardous substance of at least one of all homogeneous materials in the parts is above the relevant threshold of the SJ/T11363-2006 standard. During the environmental-friendly use period (EFUP) period, the toxic or hazardous substance or elements contained in products will not leak or mutate so that the use of these (substances or elements) will not result in any severe environmental pollution, any bodily injury or damage to any assets. The consumer is not authorized to process such kind of substances or elements, please return to the corresponding local authorities to process according to your local government statutes.

Note

- **This manual is for reference only. Slight difference may be found in the user interface.**
- **All the designs and software here are subject to change without prior written notice.**
- **All trademarks and registered trademarks mentioned are the properties of their respective owners.**
- **If there is any uncertainty or controversy, please refer to the final explanation of us.**
- **Please visit our website or contact your local service engineer for more information.**